



CIVIL AVIATION
SAFETY AUTHORITY
AUSTRALIA

Aircraft Flight Manual (AFM) CASA Approval Page

Aircraft Manufacturer or Make :	CESSNA
Aircraft Type (as in Australian Register) :	206
Aircraft Model (as in TCDS) :	U206G
Relevant NAA (National Airworthiness Authority) for AFM Document :	US FAA
AFM Document Identifier :	D1182-13PH
Serial Number Applicability Reference* :	TCDS
or Serial Numbers Applicable :	

*** Serial Number Applicability Reference Codes**

LEP - Current Log (List) of Effective Pages for the AFM Document.

TCDS - Current Type Certificate Data sheet issued by the Relevant NAA.

Title/Intro - Current Title Page or Introduction Page(s) of the AFM Document.

This Aircraft Flight Manual (AFM) is Approved by the Civil Aviation Safety Authority (CASA).
Unless specifically approved by CASA, any part of this manual that is not approved by the Relevant NAA, for an aircraft of the particular type and model or series and group as specified above, is also not approved by CASA.

Signature of Delegate of the Civil Aviation Safety Authority : _____



Printed Name of above Delegate : J R Klingberg

Effective Date of This CASA Approval Page : 18JAN2000







CIVIL AVIATION
SAFETY AUTHORITY
AUSTRALIA

Amendment Record Sheet

Aircraft Registration: VH - ASJ

Aircraft Serial Number:- U20605867

Incorporation Date	Description of Amendment	Incorporated By
10/7/02	OPERATIONS WITH CARGO DOOR REMOVED	
18/9/03	MAF SUPPLEMENT 0623-039 F01 CODAN 9323 HF SSB TRANSCEIVER	
2/4/04	MAF SUPPLEMENT 0621-002 F03 OPERATIONS WITH CABIN HEATING SYSTEM REMOVED	
28/2/06	MAF SUPPLEMENT 0625-014 F06 CARGO RESTRAINT SYSTEM	

PILOT'S OPERATING HANDBOOK

and

FAA APPROVED AIRPLANE FLIGHT MANUAL

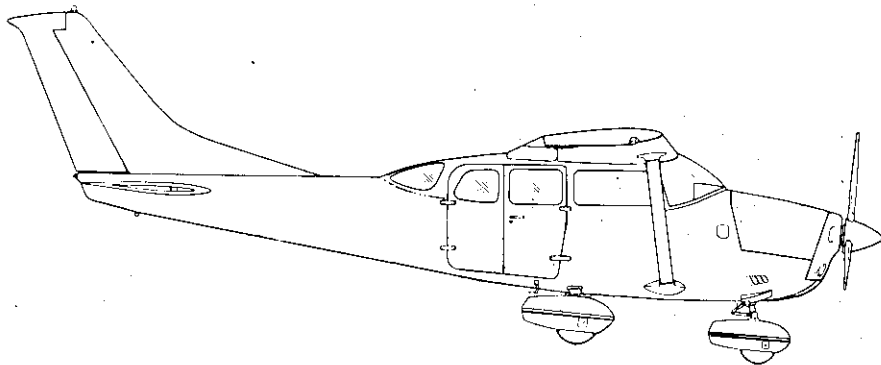

CESSNA AIRCRAFT COMPANY

1980 MODEL U206G

THIS DOCUMENT MUST BE
CARRIED IN THE AIRPLANE
AT ALL TIMES.

Serial No. U20605867

Registration No. N6402X

THIS HANDBOOK INCLUDES THE MATERIAL REQUIRED TO BE
FURNISHED TO THE PILOT BY CAR PART 3 AND CONSTITUTES
THE FAA APPROVED AIRPLANE FLIGHT MANUAL.

COPYRIGHT © 1979

CESSNA AIRCRAFT COMPANY
WICHITA, KANSAS, USA

THIS MANUAL WAS PROVIDED FOR THE AIRPLANE
IDENTIFIED ON THE TITLE PAGE ON 81-80.
SUBSEQUENT REVISIONS SUPPLIED BY CESSNA
AIRCRAFT COMPANY MUST BE PROPERLY IN-
SERTED.

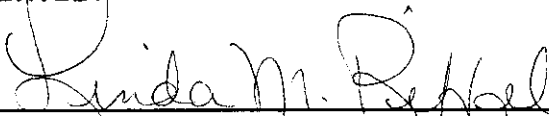
A handwritten signature in cursive script that reads "Linda M. Reffel". The signature is written over a horizontal line.

CESSNA AIRCRAFT COMPANY, PAWNEE DIVISION

CONGRATULATIONS

Welcome to the ranks of Cessna owners! Your Cessna has been designed and constructed to give you the most in performance, economy, and comfort. It is our desire that you will find flying it, either for business or pleasure, a pleasant and profitable experience.

This Pilot's Operating Handbook has been prepared as a guide to help you get the most pleasure and utility from your airplane. It contains information about your Cessna's equipment, operating procedures, and performance; and suggestions for its servicing and care. We urge you to read it from cover to cover, and to refer to it frequently.

Our interest in your flying pleasure has not ceased with your purchase of a Cessna. World-wide, the Cessna Dealer Organization backed by the Cessna Customer Services Department stands ready to serve you. The following services are offered by most Cessna Dealers:

- THE CESSNA WARRANTY, which provides coverage for parts and labor, is available at Cessna Dealers worldwide. Specific benefits and provisions of warranty, plus other important benefits for you, are contained in your Customer Care Program book, supplied with your airplane. Warranty service is available to you at authorized Cessna Dealers throughout the world upon presentation of your Customer Care Card which establishes your eligibility under the warranty.
- FACTORY TRAINED PERSONNEL to provide you with courteous expert service.
- FACTORY APPROVED SERVICE EQUIPMENT to provide you efficient and accurate workmanship.
- A STOCK OF GENUINE CESSNA SERVICE PARTS on hand when you need them.
- THE LATEST AUTHORITATIVE INFORMATION FOR SERVICING CESSNA AIRPLANES, since Cessna Dealers have all of the Service Manuals and Parts Catalogs, kept current by Service Letters and Service News Letters, published by Cessna Aircraft Company.

We urge all Cessna owners to use the Cessna Dealer Organization to the fullest.

A current Cessna Dealer Directory accompanies your new airplane. The Directory is revised frequently, and a current copy can be obtained from your Cessna Dealer. Make your Directory one of your cross-country flight planning aids; a warm welcome awaits you at every Cessna Dealer.

PERFORMANCE-
SPECIFICATIONS

CESSNA
MODEL U206G

PERFORMANCE - SPECIFICATIONS

SPEED:	
Maximum at Sea Level	156 KNOTS
Cruise, 75% Power at 6500 Ft	147 KNOTS
CRUISE: Recommended lean mixture with fuel allowance for engine start, taxi, takeoff, climb and 45 minutes reserve.	
75% Power at 6500 Ft	.Range 680 NM
88 Gallons Usable Fuel	Time 4.7 HRS
Maximum Range at 10,000 Ft	.Range 900 NM
88 Gallons Usable Fuel	Time 7.7 HRS
RATE OF CLIMB AT SEA LEVEL	920 FPM
SERVICE CEILING	14,800 FT
TAKEOFF PERFORMANCE:	
Ground Roll	900 FT
Total Distance Over 50-Ft Obstacle	1780 FT
LANDING PERFORMANCE:	
Ground Roll	735 FT
Total Distance Over 50-Ft Obstacle	1395 FT
STALL SPEED (CAS):	
Flaps Up, Power Off	62 KNOTS
Flaps Down, Power Off	54 KNOTS
MAXIMUM WEIGHT:	
Ramp	3612 LBS
Takeoff or Landing	3600 LBS
STANDARD EMPTY WEIGHT:	
Stationair 6	1927 LBS
Stationair 6 II	1987 LBS
Utility Stationair 6	1882 LBS
Utility Stationair 6 II	1941 LBS
MAXIMUM USEFUL LOAD:	
Stationair 6	1685 LBS
Stationair 6 II	1625 LBS
Utility Stationair 6	1730 LBS
Utility Stationair 6 II	1671 LBS
BAGGAGE ALLOWANCE	180 LBS
WING LOADING: Pounds/Sq Ft	20.7
POWER LOADING: Pounds/HP	12.0
FUEL CAPACITY: Total	92 GAL.
OIL CAPACITY	12 QTS
ENGINE: Teledyne Continental, Fuel Injection	10-520-F
300 BHP at 2850 RPM (5-Minute Takeoff Rating)	
285 BHP at 2700 RPM (Maximum Continuous Rating)	
PROPELLER: 3-Bladed Constant Speed, Diameter	80 IN.

COVERAGE

The Pilot's Operating Handbook in the airplane at the time of delivery from Cessna Aircraft Company contains information applicable to the 1980 Model U206G airplane designated by the serial number and registration number shown on the Title Page of this handbook.

REVISIONS

Changes and/or additions to this handbook will be covered by revisions published by Cessna Aircraft Company. These revisions are distributed to all Cessna Dealers and to owners of U. S. Registered aircraft according to FAA records at the time of revision issuance.

Revisions should be examined immediately upon receipt and incorporated in this handbook.

NOTE

It is the responsibility of the owner to maintain this handbook in a current status when it is being used for operational purposes.

Owners should contact their Cessna Dealer whenever the revision status of their handbook is in question.

A revision bar will extend the full length of new or revised text and/or illustrations added on new or presently existing pages. This bar will be located adjacent to the applicable revised area on the outer margin of the page.

All revised pages will carry the revision number and date on the applicable page.

The following Log of Effective Pages provides the dates of issue for original and revised pages, and listing of all pages in the handbook. Pages affected by the current revision are indicated by an asterisk (*) preceding the pages listed.

LOG OF EFFECTIVE PAGES

Dates of issue for original and revised pages are:

- Original 1 October 1979
- Revision 1 28 March 1980
- Revision 2 5 December 1980

Page	Date	Page	Date
Title	1 October 1979	5-9 thru 5-28	1 October 1979
Assignment Record	1 October 1979	6-1	1 October 1979
i thru ii	1 October 1979	6-2 Blank	1 October 1979
iii	5 December 1980	6-3 thru 6-15	1 October 1979
iv	1 October 1979	6-16 Blank	1 October 1979
1-1 thru 1-8	1 October 1979	6-17 thru 6-32	1 October 1979
2-1	1 October 1979	7-1 thru 7-15	1 October 1979
2-2 Blank	1 October 1979	*7-16 thru 7-16A	5 December 1980
2-3 thru 2-9	1 October 1979	*7-16B Blank	5 December 1980
*2-10	5 December 1980	7-17 thru 7-44	1 October 1979
2-11	28 March 1980	8-1	1 October 1979
2-12 Blank	1 October 1979	8-2 Blank	1 October 1979
3-1 thru 3-18	1 October 1979	8-3 thru 8-17	1 October 1979
4-1 thru 4-11	1 October 1979	8-18 Blank	1 October 1979
4-12 Blank	1 October 1979	9-1 thru 9-3	1 October 1979
4-13 thru 4-22	1 October 1979	9-4 Blank	1 October 1979
5-1	1 October 1979		
5-2 Blank	1 October 1979		
5-3 thru 5-7	1 October 1979		
5-8 Blank	1 October 1979		

NOTE

Refer to Section 9 Table of Contents for supplements applicable to optional systems.

TABLE OF CONTENTS

	SECTION
GENERAL.....	1
LIMITATIONS.....	2
EMERGENCY PROCEDURES.....	3
NORMAL PROCEDURES.....	4
PERFORMANCE.....	5
WEIGHT & BALANCE/ EQUIPMENT LIST	6
AIRPLANE & SYSTEMS DESCRIPTIONS	7
AIRPLANE HANDLING, SERVICE & MAINTENANCE	8
SUPPLEMENTS (Optional Systems Description & Operating Procedures)	9

SECTION 1 GENERAL

TABLE OF CONTENTS

	Page
Three View	1-2
Introduction	1-3
Descriptive Data	1-3
Engine	1-3
Propeller	1-3
Fuel	1-3
Oil	1-4
Maximum Certificated Weights	1-4
Standard Airplane Weights	1-5
Cabin And Entry Dimensions	1-5
Baggage Space And Cargo Door Entry Dimensions	1-5
Specific Loadings	1-5
Symbols, Abbreviations And Terminology	1-5
General Airspeed Terminology And Symbols	1-5
Meteorological Terminology	1-6
Engine Power Terminology	1-6
Airplane Performance And Flight Planning Terminology	1-7
Weight And Balance Terminology	1-7

SECTION 1
GENERAL

CESSNA
MODEL U206G

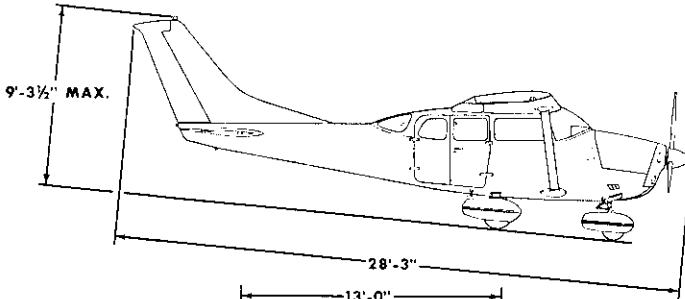

NOTES:

1. Dimensions shown are based on standard empty weight and proper nose gear and tire inflation.
2. Dimensions shown reflect standard nose and main gear tire installation.
3. Wing span shown with strobe lights installed.
4. Maximum height shown with nose gear depressed as far as possible.
5. Wheel base length is 69 1/4".
6. Propeller ground clearance is 11 3/4".
7. Wing area is 174 square feet.
8. Minimum turning radius (* pivot point to outboard wing tip) is 25'.

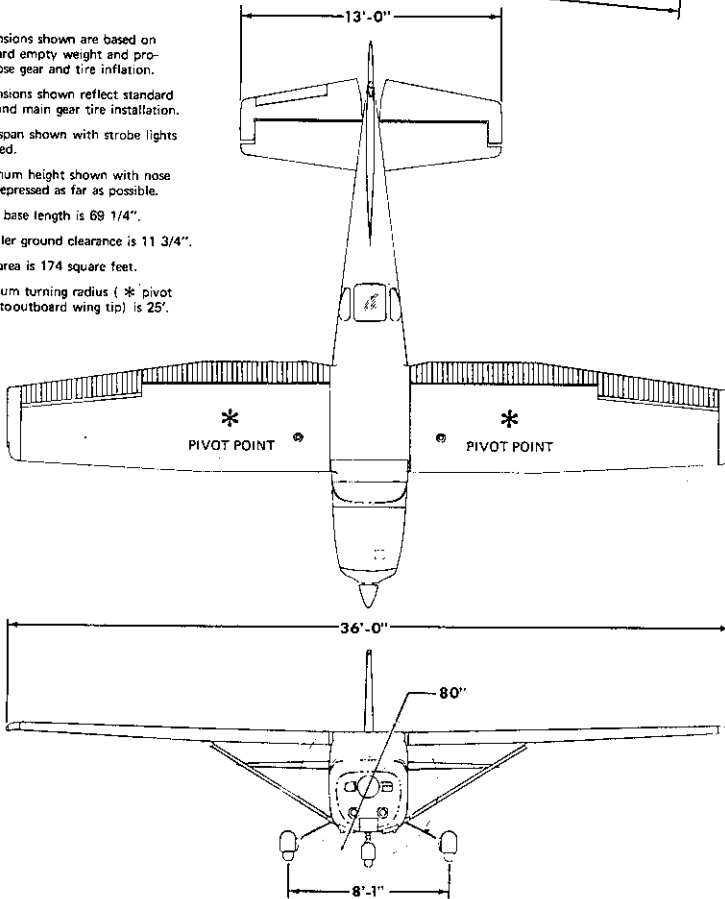

Figure 1-1. Three View

INTRODUCTION

This handbook contains 9 sections, and includes the material required to be furnished to the pilot by CAR Part 3. It also contains supplemental data supplied by Cessna Aircraft Company.

Section 1 provides basic data and information of general interest. It also contains definitions or explanations of symbols, abbreviations, and terminology commonly used.

DESCRIPTIVE DATA

ENGINE

Number of Engines: 1.

Engine Manufacturer: Teledyne Continental.

Engine Model Number: IO-520-F.

Engine Type: Normally-aspirated, direct-drive, air-cooled, horizontally-opposed, fuel-injected, six-cylinder engine with 520 cu. in. displacement.

Horsepower Rating and Engine Speed:

Maximum Power (5 minutes - takeoff): 300 rated BHP at 2850 RPM.

Maximum Continuous Power: 285 rated BHP at 2700 RPM.

PROPELLER

Propeller Manufacturer: McCauley Accessory Division.

Propeller Model Number: D3A34C404/80VA-0.

Number of Blades: 3.

Propeller Diameter, Maximum: 80 inches.

Minimum: 78.5 inches.

Propeller Type: Constant speed and hydraulically actuated, with a low pitch setting of 11.0° and a high pitch setting of 27.0° (30 inch station).

FUEL

Approved Fuel Grades (and Colors):

100LL Grade Aviation Fuel (Blue).

100 (Formerly 100/130) Grade Aviation Fuel (Green).

NOTE

Isopropyl alcohol or ethylene glycol monomethyl ether may be added to the fuel supply. Additive concentrations shall not exceed 1% for isopropyl alcohol or .15% for ethylene glycol monomethyl ether. Refer to Section 8 for

additional information.

Total Capacity: 92 gallons.
Total Capacity Each Tank: 46 gallons.
Total Usable: 88 gallons.

(STANDARD)

OIL

Oil Grade (Specification):

MIL-L-6082 Aviation Grade Straight Mineral Oil: Use to replenish supply during first 25 hours and at the first 25-hour oil change. Continue to use until a total of 50 hours has accumulated or oil consumption has stabilized.

NOTE

The airplane was delivered from the factory with a corrosion preventive aircraft engine oil. This oil should be drained after the first 25 hours of operation.

Continental Motors Specification MHS-24 (and all revisions thereto), Ashless Dispersant Oil: This oil **must be used** after first 50 hours or oil consumption has stabilized.

Recommended Viscosity for Temperature Range:

All temperatures, use SAE 20W-50 or
Above 4°C (40°F), use SAE 50
Below 4°C (40°F), use SAE 30

NOTE

Multi-viscosity oil with a range of SAE 20W-50 is recommended for improved starting in cold weather.

Oil Capacity:

Sump: 12 Quarts.
Total: 13 Quarts (if oil filter installed).

MAXIMUM CERTIFICATED WEIGHTS

Ramp: 3612 lbs.

Takeoff: 3600 lbs. (1633 kg)

Landing: 3600 lbs. (1633 kg)

Weight in Baggage Compartment - Station 109 to 145: 180 lbs maximum. (82 kg)

NOTE

Refer to Section 6 of this handbook for loading arrangements with one or more seats removed for cargo accommodation.

STANDARD AIRPLANE WEIGHTS

Standard Empty Weight, Stationair 6: 1927 lbs.
Stationair 6 II: 1987 lbs.
Utility Stationair 6: 1882 lbs.
Utility Stationair 6 II: 1941 lbs.
Maximum Useful Load, Stationair 6: 1685 lbs.
Stationair 6 II: 1625 lbs.
Utility Stationair 6: 1730 lbs.
Utility Stationair 6 II: 1671 lbs.

CABIN AND ENTRY DIMENSIONS

Detailed dimensions of the cabin interior and entry door opening are illustrated in Section 6.

BAGGAGE SPACE AND CARGO DOOR ENTRY DIMENSIONS

Dimensions of the baggage/cargo area and cargo door opening are illustrated in detail in Section 6.

SPECIFIC LOADINGS

Wing Loading: 20.7 lbs./sq. ft.
Power Loading: 12.0 lbs./hp.

SYMBOLS, ABBREVIATIONS AND TERMINOLOGY

GENERAL AIRSPEED TERMINOLOGY AND SYMBOLS

- KCAS** **Knots Calibrated Airspeed** is indicated airspeed corrected for position and instrument error and expressed in knots. Knots calibrated airspeed is equal to KTAS in standard atmosphere at sea level.
- KIAS** **Knots Indicated Airspeed** is the speed shown on the airspeed indicator and expressed in knots.
- KTAS** **Knots True Airspeed** is the airspeed expressed in knots relative to undisturbed air which is KCAS corrected for altitude and temperature.
- V_A** **Maneuvering Speed** is the maximum speed at which you may use abrupt control travel.

- V_{FE} **Maximum Flap Extended Speed** is the highest speed permissible with wing flaps in a prescribed extended position.
- V_{NO} **Maximum Structural Cruising Speed** is the speed that should not be exceeded except in smooth air, then only with caution.
- V_{NE} **Never Exceed Speed** is the speed limit that may not be exceeded at any time.
- V_S **Stalling Speed or the minimum steady flight speed** at which the airplane is controllable.
- V_{SO} **Stalling Speed or the minimum steady flight speed** at which the airplane is controllable in the landing configuration at the most forward center of gravity.
- V_X **Best Angle-of-Climb Speed** is the speed which results in the greatest gain of altitude in a given horizontal distance.
- V_Y **Best Rate-of-Climb Speed** is the speed which results in the greatest gain in altitude in a given time.

METEOROLOGICAL TERMINOLOGY

- OAT **Outside Air Temperature** is the free air static temperature. It is expressed in either degrees Celsius or degrees Fahrenheit.
- Standard Temperature **Standard Temperature** is 15°C at sea level pressure altitude and decreases by 2°C for each 1000 feet of altitude.
- Pressure Altitude **Pressure Altitude** is the altitude read from an altimeter when the altimeter's barometric scale has been set to 29.92 inches of mercury (1013 mb).

ENGINE POWER TERMINOLOGY

- BHP **Brake Horsepower** is the power developed by the engine. Percent power values in this handbook are based on the maximum continuous power rating.
- RPM **Revolutions Per Minute** is engine speed.
- MP **Manifold Pressure** is a pressure measured in the engine's

induction system and is expressed in inches of mercury (Hg).

AIRPLANE PERFORMANCE AND FLIGHT PLANNING TERMINOLOGY

Demonstrated Crosswind Velocity **Demonstrated Crosswind Velocity** is the velocity of the crosswind component for which adequate control of the airplane during takeoff and landing was actually demonstrated during certification tests. The value shown is not considered to be limiting.

Usable Fuel **Usable Fuel** is the fuel available for flight planning.

Unusable Fuel **Unusable Fuel** is the quantity of fuel that can not be safely used in flight.

GPH **Gallons Per Hour** is the amount of fuel (in gallons) consumed per hour.

NMPG **Nautical Miles Per Gallon** is the distance (in nautical miles) which can be expected per gallon of fuel consumed at a specific engine power setting and/or flight configuration.

g **g** is acceleration due to gravity.

WEIGHT AND BALANCE TERMINOLOGY

Reference Datum **Reference Datum** is an imaginary vertical plane from which all horizontal distances are measured for balance purposes.

Station **Station** is a location along the airplane fuselage given in terms of the distance from the reference datum.

Arm **Arm** is the horizontal distance from the reference datum to the center of gravity (C.G.) of an item.

Moment **Moment** is the product of the weight of an item multiplied by its arm. (Moment divided by the constant 1000 is used in this handbook to simplify balance calculations by reducing the number of digits.)

Center of Gravity (C.G.) **Center of Gravity** is the point at which an airplane, or equipment, would balance if suspended. Its distance from the reference datum is found by dividing the total moment

SECTION 1
GENERAL

CESSNA
MODEL U206G

by the total weight of the airplane.

C.G. Arm **Center of Gravity Arm** is the arm obtained by adding the airplane's individual moments and dividing the sum by the total weight.

C.G. Limits **Center of Gravity Limits** are the extreme center of gravity locations within which the airplane must be operated at a given weight.

Standard Empty Weight **Standard Empty Weight** is the weight of a standard airplane, including unusable fuel, full operating fluids and full engine oil.

Basic Empty Weight **Basic Empty Weight** is the standard empty weight plus the weight of optional equipment.

Useful Load **Useful Load** is the difference between ramp weight and the basic empty weight.

Maximum Ramp Weight **Maximum Ramp Weight** is the maximum weight approved for ground maneuver. (It includes the weight of start, taxi and runup fuel.)

Maximum Takeoff Weight **Maximum Takeoff Weight** is the maximum weight approved for the start of the takeoff run.

Maximum Landing Weight **Maximum Landing Weight** is the maximum weight approved for the landing touchdown.

Tare **Tare** is the weight of chocks, blocks, stands, etc. used when weighing an airplane, and is included in the scale readings. Tare is deducted from the scale reading to obtain the actual (net) airplane weight.

SECTION 2 LIMITATIONS

TABLE OF CONTENTS

	Page
Introduction	2-3
Airspeed Limitations	2-4
Airspeed Indicator Markings	2-4
Power Plant Limitations	2-5
Power Plant Instrument Markings	2-6
Weight Limits	2-6
Center Of Gravity Limits	2-7
Maneuver Limits	2-7
Flight Load Factor Limits	2-7
Kinds Of Operation Limits	2-7
Fuel Limitations	2-8
Other Limitations	2-8
Flap Limitations	2-8
Placards	2-9

INTRODUCTION

Section 2 includes operating limitations, instrument markings, and basic placards necessary for the safe operation of the airplane, its engine, standard systems and standard equipment. The limitations included in this section and in Section 9 have been approved by the Federal Aviation Administration. Observance of these operating limitations is required by Federal Aviation Regulations.

NOTE

Refer to Section 9 of this Pilot's Operating Handbook for amended operating limitations, operating procedures, performance data and other necessary information for airplanes equipped with specific options.

NOTE

The airspeeds listed in the Airspeed Limitations chart (figure 2-1) and the Airspeed Indicator Markings chart (figure 2-2) are based on Airspeed Calibration data shown in Section 5 with the normal static source. If the alternate static source is being used, ample margins should be observed to allow for the airspeed calibration variations between the normal and alternate static sources as shown in Section 5.

Your Cessna is certificated under FAA Type Certificate No. A4CE as Cessna Model No. U206G.

AIRSPPEED LIMITATIONS

Airspeed limitations and their operational significance are shown in figure 2-1.

	SPEED	KCAS	KIAS	REMARKS
V _{NE}	Never Exceed Speed	182	183	Do not exceed this speed in any operation.
V _{NO}	Maximum Structural Cruising Speed	148	149	Do not exceed this speed except in smooth air, and then only with caution.
V _A	Maneuvering Speed: 3600 Pounds 2900 Pounds 2200 Pounds	120 107 95	120 106 93	Do not make full or abrupt control movements above this speed.
V _{FE}	Maximum Flap Extended Speed: To 10° Flaps 10° - 40° Flaps	139 101	140 100	Do not exceed these speeds with the given flap settings.
	Maximum Window Open Speed	182	183	Do not exceed this speed with windows open.

Figure 2-1. Airspeed Limitations

AIRSPPEED INDICATOR MARKINGS

Airspeed indicator markings and their color code significance are shown in figure 2-2.

MARKING	KIAS VALUE OR RANGE	SIGNIFICANCE
White Arc	46 - 100	Full Flap Operating Range. Lower limit is maximum weight V_{S_0} in landing configuration. Upper limit is maximum speed permissible with flaps extended.
Green Arc	55 - 149	Normal Operating Range. Lower limit is maximum weight V_S at most forward C.G. with flaps retracted. Upper limit is maximum structural cruising speed.
Yellow Arc	149 - 183	Operations must be conducted with caution and only in smooth air.
Red Line	183	Maximum speed for all operations.

Figure 2-2. Airspeed Indicator Markings

POWER PLANT LIMITATIONS

Engine Manufacturer: Teledyne Continental.

Engine Model Number: IO-520-F.

Engine Operating Limits for Takeoff and Continuous Operations:

Maximum Power, 5 Minutes - Takeoff: 300 BHP rating.

Continuous: 285 BHP rating.

Maximum Engine Speed, 5 Minutes - Takeoff: 2850 RPM.

Continuous: 2700 RPM.

Maximum Cylinder Head Temperature: 460°F (238°C).

Maximum Oil Temperature: 240°F (116°C).

Oil Pressure, Minimum: 10 psi.

Maximum: 100 psi.

Fuel Pressure, Minimum: 3.5 psi.

Maximum: 19.5 psi (25.2 gal/hr).

Propeller Manufacturer: McCauley Accessory Division.

Propeller Model Number: D3A34C404/80VA-0.

Propeller Diameter, Maximum: 80 inches.

Minimum: 78.5 inches.

Propeller Blade Angle at 30 Inch Station, Low: 11.0°.

High: 27.0°.

POWER PLANT INSTRUMENT MARKINGS

Power plant instrument markings and their color code significance are shown in figure 2-3.

INSTRUMENT	RED LINE	GREEN ARC	YELLOW ARC	RED LINE
	MINIMUM LIMIT	NORMAL OPERATING	CAUTION RANGE	MAXIMUM LIMIT
Tachometer	---	2200 - 2550 RPM	2700 - 2850 RPM	2850 RPM
Manifold Pressure	---	15-25 in.Hg	---	---
Oil Temperature	---	100° - 240°F	---	240°F
Cylinder Head Temperature	---	200° - 460°F	---	460°F
Fuel Flow (Pressure)	(3.5 psi)	7.0 - 17.0 gal/hr	---	25.2 gal/hr (19.5 psi)
Oil Pressure	10 psi	30-60 psi	---	100 psi
Fuel Quantity	E (2.0 Gal Unusable Each Tank)	---	---	---
Suction	---	4.6 - 5.4 in. Hg	---	---

Figure 2-3. Power Plant Instrument Markings

WEIGHT LIMITS

Maximum Ramp Weight: 3612 lbs.

Maximum Takeoff Weight: 3600 lbs.

Maximum Landing Weight: 3600 lbs.

Maximum Weight in Baggage Compartment - Station 109 to 145: 180 lbs.

NOTE

Refer to Section 6 of this handbook for loading arrangements with one or more seats removed for cargo accommodation.

CENTER OF GRAVITY LIMITS

Center of Gravity Range:

Forward: 33.0 inches aft of datum at 2500 lbs. or less, with straight line variation to 42.5 inches aft of datum at 3600 lbs.

Aft: 49.7 inches aft of datum at all weights.

Reference Datum: Lower portion of front face of firewall.

MANEUVER LIMITS

This airplane is certificated in the normal category. The normal category is applicable to aircraft intended for non-aerobatic operations. These include any maneuvers incidental to normal flying, stalls (except whip stalls), lazy eights, chandelles, and turns in which the angle of bank is not more than 60°.

Aerobatic maneuvers, including spins, are not approved.

FLIGHT LOAD FACTOR LIMITS

Flight Load Factors:

*Flaps Up: +3.8g, -1.52g

*Flaps Down: +2.0g

*The design load factors are 150% of the above, and in all cases, the structure meets or exceeds design loads.

KINDS OF OPERATION LIMITS

The airplane is equipped for day VFR and may be equipped for night VFR and/or IFR operations. FAR Part 91 establishes the minimum required instrumentation and equipment for these operations. The reference to types of flight operations on the operating limitations placard reflects equipment installed at the time of Airworthiness Certificate issuance.

Flight into known icing conditions is prohibited.

FUEL LIMITATIONS

2 Standard Tanks: 46.0 U.S. gallons each.

Total Fuel: 92 U.S. gallons.

Usable Fuel (all flight conditions): 88 U.S. gallons.

Unusable Fuel: 4.0 U.S. gallons.

With low fuel reserves, do not allow the airplane to remain in uncoordinated flight for periods in excess of one minute.

Use fuller tank for takeoff and landing.

Approved Fuel Grades (and Colors):

100LL Grade Aviation Fuel (Blue).

100 (Formerly 100/130) Grade Aviation Fuel (Green).

OTHER LIMITATIONS

FLAP LIMITATIONS

Approved Takeoff Range: 0° to 20°.

Approved Landing Range: 0° to 40°.

PLACARDS

The following information must be displayed in the form of composite or individual placards.

1. In full view of the pilot: (The "DAY-NIGHT-VFR-IFR" entry, shown on the example below, will vary as the airplane is equipped.)

The markings and placards installed in this airplane contain operating limitations which must be complied with when operating this airplane in the Normal Category. Other operating limitations which must be complied with when operating this airplane in this category are contained in the Pilot's Operating Handbook and FAA Approved Airplane Flight Manual.

No acrobatic maneuvers, including spins, approved.

Flight into known icing conditions prohibited.

This airplane is certified for the following flight operations as of date of original airworthiness certificate:

DAY - NIGHT - VFR - IFR

2. On control lock:

CONTROL LOCK - REMOVE BEFORE STARTING ENGINE.

3. On fuel selector plate, at appropriate locations:

WHEN SWITCHING FROM DRY TANK TURN AUX FUEL PUMP
"ON" MOMENTARILY.

TAKEOFF AND LAND ON FULLER TANK.
LEFT ON -- 44.0 GAL.
RIGHT ON -- 44.0 GAL.
OFF.

4. Forward of fuel tank filler caps:

FUEL
100LL/100 MIN. GRADE AVIATION GASOLINE
CAP. 46.0 U.S. GAL.
CAP. 34.5 U.S. GAL. TO BOTTOM OF FILLER COLLAR

5. Near manifold pressure/fuel flow indicator:

RPM	MIN. FUEL FLOWS AT FULL THROTTLE			
	S.L.	4000	8000	12000
2700	23 GPH	21 GPH	19 GPH	17 GPH
2850	24 GPH	22 GPH	20 GPH	18 GPH

6. On the flap control indicator:

UP to 10°	(Partial flap range with blue color code and 140 knot callout; also, mechanical detent at 10°.)
10° to 40°	(Indices at these positions with white color code and 100 knot callout; also, mechanical detent at 20°.)

7. On aft cargo door:

BAGGAGE NET 180 LBS MAX CAPACITY
REFER TO WEIGHT AND BALANCE DATA
FOR BAGGAGE AND CARGO LOADING.

8. On forward cargo door:

EMERGENCY EXIT OPERATION

1. ROTATE FORWARD CARGO DOOR HANDLE FULL FORWARD THEN FULL AFT.
2. OPEN FORWARD CARGO DOOR AS FAR AS POSSIBLE.
3. ROTATE RED LEVER IN REAR CARGO DOOR FORWARD.
4. FORCE REAR CARGO DOOR FULL OPEN.

9. A calibration card is provided to indicate the accuracy of the magnetic compass in 30° increments.

10. On oil filler cap:

OIL
12 QTS

11. Near airspeed indicator:

MANEUVER SPEED
120 KIAS

12. Forward of each fuel tank filler cap in line with fwd arrow.

FUEL CAP FWD ▲ ARROW ALIGNMENT
CAP MUST NOT ROTATE DURING CLOSING

SECTION 3

EMERGENCY PROCEDURES

TABLE OF CONTENTS

	Page
Introduction	3-3
Airspeeds For Emergency Operation	3-3
OPERATIONAL CHECKLISTS	
Engine Failures	3-3
Engine Failure During Takeoff Run	3-3
Engine Failure Immediately After Takeoff	3-4
Engine Failure During Flight (Restart Procedures)	3-4
Forced Landings	3-4
Emergency Landing Without Engine Power	3-4
Precautionary Landing With Engine Power	3-5
Ditching	3-5
Fires	3-5
During Start On Ground	3-5
Engine Fire In Flight	3-6
Electrical Fire In Flight	3-6
Cabin Fire	3-7
Wing Fire	3-7
Icing	3-8
Inadvertent Icing Encounter	3-8
Static Source Blockage (Erroneous Instrument Reading Suspected)	3-9
Landing With A Flat Main Tire	3-9
Electrical Power Supply System Malfunctions	3-9
Ammeter Shows Excessive Rate of Charge (Full Scale Deflection)	3-9
Low-Voltage Light Illuminates During Flight (Ammeter Indicates Discharge)	3-9
AMPLIFIED PROCEDURES	
Engine Failure	3-11
Forced Landings	3-12

TABLE OF CONTENTS (Continued)

	Page
Landing Without Elevator Control	3-12
Fires	3-12
Emergency Operation In Clouds (Vacuum System Failure)	3-13
Executing A 180° Turn In Clouds	3-13
Emergency Descent Through Clouds	3-13
Recovery From A Spiral Dive	3-14
Inadvertent Flight Into Icing Conditions	3-14
Static Source Blocked	3-14
Spins	3-15
Rough Engine Operation Or Loss Of Power	3-15
Spark Plug Fouling	3-15
Magneto Malfunction	3-16
Engine-Driven Fuel Pump Failure	3-16
Low Oil Pressure	3-16
Electrical Power Supply System Malfunctions	3-17
Excessive Rate Of Charge	3-17
Insufficient Rate Of Charge	3-17
Cargo Door Emergency Exit	3-18

INTRODUCTION

Section 3 provides checklist and amplified procedures for coping with emergencies that may occur. Emergencies caused by airplane or engine malfunctions are extremely rare if proper preflight inspections and maintenance are practiced. Enroute weather emergencies can be minimized or eliminated by careful flight planning and good judgment when unexpected weather is encountered. However, should an emergency arise, the basic guidelines described in this section should be considered and applied as necessary to correct the problem. Emergency procedures associated with ELT and other optional systems can be found in Section 9.

AIRSPEEDS FOR EMERGENCY OPERATION

Engine Failure After Takeoff:

Wing Flaps Up	80 KIAS
Wing Flaps Down	70 KIAS

Maneuvering Speed:

3600 Lbs	120 KIAS
2900 Lbs	106 KIAS
2200 Lbs	93 KIAS

Maximum Glide:

3600 Lbs	75 KIAS
3200 Lbs	70 KIAS
2800 Lbs	65 KIAS

Precautionary Landing With Engine Power 70 KIAS

Landing Without Engine Power:

Wing Flaps Up	80 KIAS
Wing Flaps Down	70 KIAS

OPERATIONAL CHECKLISTS

ENGINE FAILURES

ENGINE FAILURE DURING TAKEOFF RUN

1. Throttle -- IDLE.
2. Brakes -- APPLY.
3. Wing Flaps -- RETRACT.
4. Mixture -- IDLE CUT-OFF.
5. Ignition Switch -- OFF.
6. Master Switch -- OFF.

ENGINE FAILURE IMMEDIATELY AFTER TAKEOFF

1. Airspeed -- 80 KIAS.
2. Mixture -- IDLE CUT-OFF.
3. Fuel Selector Valve -- OFF.
4. Ignition Switch -- OFF.
5. Wing Flaps -- AS REQUIRED (40° recommended).
6. Master Switch -- OFF.

ENGINE FAILURE DURING FLIGHT (RESTART PROCEDURES)

1. Airspeed -- 75 KIAS.
2. Auxiliary Fuel Pump -- ON.
3. Fuel Selector Valve -- OPPOSITE TANK (if it contains fuel).
4. Throttle -- HALF OPEN.
5. Auxiliary Fuel Pump -- OFF.

NOTE

If the fuel flow indication immediately drops to zero, signifying an engine-driven fuel pump failure, return the auxiliary fuel pump switch to ON.

6. Mixture -- LEAN from full rich until restart occurs.

NOTE

If propeller is windmilling, engine will restart automatically within a few seconds. If propeller has stopped (possible at low speeds), turn ignition switch to START, advance throttle slowly from idle, and (at higher altitudes) lean the mixture from full rich.

7. Mixture -- ADJUST as required as power is restored.
8. Throttle -- ADJUST power as required.
9. Fuel Selector Valve -- AS DESIRED after fuel flow is stabilized.

FORCED LANDINGS

EMERGENCY LANDING WITHOUT ENGINE POWER

1. Airspeed -- 80 KIAS (flaps UP).
70 KIAS (flaps DOWN).
2. Mixture -- IDLE CUT-OFF.
3. Fuel Selector Valve -- OFF.
4. Ignition Switch -- OFF.

5. Wing Flaps -- AS REQUIRED (40° recommended).
6. Master Switch -- OFF.
7. Doors -- UNLATCH PRIOR TO TOUCHDOWN.
8. Touchdown -- SLIGHTLY TAIL LOW.
9. Brakes -- APPLY HEAVILY.

PRECAUTIONARY LANDING WITH ENGINE POWER

1. Airspeed -- 80 KIAS.
2. Wing Flaps -- 20°.
3. Selected Field -- FLY OVER, noting terrain and obstructions, then retract flaps upon reaching a safe altitude and airspeed.
4. Electrical Switches -- OFF.
5. Wing Flaps -- 40° (on final approach).
6. Airspeed -- 70 KIAS.
7. Avionics Power and Master Switches -- OFF.
8. Doors -- UNLATCH PRIOR TO TOUCHDOWN.
9. Touchdown -- SLIGHTLY TAIL LOW.
10. Ignition Switch -- OFF.
11. Brakes -- APPLY HEAVILY.

DITCHING

1. Radio -- TRANSMIT MAYDAY on 121.5 MHz, giving location and intentions, and SQUAWK 7700 if transponder is installed.
2. Heavy Objects (in baggage area) -- SECURE OR JETTISON.
3. Wing Flaps -- 40°.
4. Approach -- High Winds, Heavy Seas -- INTO THE WIND.
Light Winds, Heavy Swells -- PARALLEL TO SWELLS.
5. Power -- ESTABLISH 300 FT/MIN DESCENT AT 65 KIAS.
6. Cabin Doors -- UNLATCH.
7. Touchdown -- LEVEL ATTITUDE AT 300 FT/MIN DESCENT.
8. Face -- CUSHION at touchdown with folded coat.
9. Airplane -- EVACUATE through cabin doors. If necessary, open window and flood cabin to equalize pressure so doors can be opened.
10. Life Vests and Raft -- INFLATE.

FIRES

DURING START ON GROUND

1. Ignition Switch -- START (continue cranking to obtain start).
2. Auxiliary Fuel Pump -- OFF.

If engine starts:

3. Power -- 1700 RPM for a few minutes.
4. Engine -- SHUTDOWN and inspect for damage.

If engine fails to start:

3. Ignition Switch -- START (continue cranking).
4. Throttle -- FULL OPEN.
5. Mixture -- IDLE CUT-OFF.
6. Fire Extinguisher -- OBTAIN (have ground attendants obtain if not installed).
7. Engine -- SECURE.
 - a. Ignition Switch -- OFF.
 - b. Master Switch -- OFF.
 - c. Fuel Selector Valve -- OFF.
8. Fire -- EXTINGUISH using fire extinguisher, wool blanket or dirt.

NOTE

If sufficient ground personnel are available (and fire is on ground and not too dangerous) move airplane away from the fire by pushing rearward on the leading edge of the horizontal tail.

9. Fire Damage -- INSPECT, repair damage or replace damaged components or wiring before conducting another flight.

ENGINE FIRE IN FLIGHT

1. Mixture -- IDLE CUT-OFF.
2. Fuel Selector Valve -- OFF.
3. Master Switch -- OFF.
4. Cabin Heat and Air -- OFF (except overhead vents).
5. Airspeed -- 105 KIAS (If fire is not extinguished, increase glide speed to find an airspeed which will provide an incombustible mixture).
6. Forced Landing -- EXECUTE (as described in Emergency Landing Without Engine Power).

ELECTRICAL FIRE IN FLIGHT

1. Master Switch -- OFF.
2. Avionics Power Switch -- OFF.
3. All Other Switches (except ignition switch) -- OFF.
4. Vents/Cabin Air/Heat -- CLOSED.
5. Fire Extinguisher -- ACTIVATE (if available).

WARNING

If an oxygen system is available, occupants should use oxygen masks until smoke and discharged dry powder clears. After discharging an extinguisher within a closed cabin, ventilate the cabin.

If fire appears out and electrical power is necessary for continuance of flight:

6. Master Switch -- ON.
7. Circuit Breakers -- CHECK for faulty circuit; do not reset.
8. Radio Switches -- OFF.
9. Avionics Power Switch -- ON.
10. Radio/Electrical Switches -- ON one at a time, with delay after each until short circuit is localized.
11. Vents/Cabin Air/Heat -- OPEN when it is ascertained that fire is completely extinguished.

CABIN FIRE

1. Master Switch -- OFF.
2. Vents/Cabin Air/Heat -- CLOSED (to avoid drafts).
3. Fire Extinguisher -- ACTIVATE (if available).

WARNING

If an oxygen system is available, occupants should use oxygen masks until smoke and discharged dry powder clears. After discharging an extinguisher within a closed cabin, ventilate the cabin.

4. Land the airplane as soon as possible to inspect for damage.

WING FIRE

1. Navigation Light Switch -- OFF.
2. Pitot Heat Switch (if installed) -- OFF.
3. Strobe Light Switch (if installed) -- OFF.

NOTE

Perform a sideslip to keep the flames away from the fuel tank and cabin, and land as soon as possible.

ICING

INADVERTENT ICING ENCOUNTER

1. Turn pitot heat switch ON (if installed).
2. Turn back or change altitude to obtain an outside air temperature that is less conducive to icing.
3. Pull cabin heat control full out and rotate defrost knob clockwise to obtain maximum windshield defroster effectiveness.
4. Increase engine speed to minimize ice build-up on propeller blades. If excessive vibration is noted, momentarily reduce engine speed to 2200 RPM with the propeller control, and then rapidly move the control full forward.

NOTE

Cycling the RPM flexes the propeller blades and high RPM increases centrifugal force, causing ice to shed more readily.

5. Watch for signs of induction air filter ice and regain manifold pressure by increasing the throttle setting.

NOTE

If ice accumulates on the intake filter (causing the alternate air door to open), a decrease of 1 to 2 inches of full throttle manifold pressure will be experienced.

6. If icing conditions are unavoidable, plan a landing at the nearest airport. With an extremely rapid ice build-up, select a suitable "off airport" landing site.
7. With an ice accumulation of 1/4 inch or more on the wing leading edges, be prepared for a significantly higher power requirement, approach speed, stall speed, and landing roll.
8. Open the window and, if practical, scrape ice from a portion of the windshield for visibility in the landing approach.
9. Use a 10° - 20° landing flap setting for ice accumulations of 1 inch or less. With heavier ice accumulations, approach with flaps retracted to ensure adequate elevator effectiveness in the approach and landing.
10. Approach at 90-100 KIAS with 20° flaps and 105-115 KIAS with 0°-10° flaps, depending upon the amount of ice accumulation. If ice accumulation is unusually large, decelerate to the planned approach speed while in the approach configuration at a high enough altitude which would permit recovery in the event that a stall buffet is encountered.

11. Land on the main wheels first, avoiding the slow and high type of flare-out.
12. Missed approaches should be avoided whenever possible because of severely reduced climb capability. However, if a go-around is mandatory, make the decision much earlier in the approach than normal. Apply maximum power and maintain 95 KIAS while retracting the flaps slowly in 10° increments.

STATIC SOURCE BLOCKAGE (Erroneous Instrument Reading Suspected)

1. Vents and Windows -- CLOSED.
2. Alternate Static Source Valve (if installed) -- PULL ON.
3. Airspeed -- Consult calibration table in Section 5.

LANDING WITH A FLAT MAIN TIRE

1. Wing Flaps -- AS DESIRED (0° - 10° below 140 KIAS, 10° - 40° below 100 KIAS).
2. Make a normal approach.
3. Touchdown -- GOOD TIRE FIRST, hold airplane off flat tire as long as possible with aileron control.

ELECTRICAL POWER SUPPLY SYSTEM MALFUNCTIONS

AMMETER SHOWS EXCESSIVE RATE OF CHARGE (Full Scale Deflection)

1. Alternator -- OFF.
2. Alternator Circuit Breaker -- PULL.
3. Nonessential Radio/Electrical Equipment -- OFF.
4. Flight -- TERMINATE as soon as practical.

LOW-VOLTAGE LIGHT ILLUMINATES DURING FLIGHT (Ammeter Indicates Discharge)

NOTE

Illumination of the low-voltage light may occur during low RPM conditions with an electrical load on the system such as during a low RPM taxi. Under these conditions, the light will go out at higher RPM. The master switch need not

SECTION 3
EMERGENCY PROCEDURES

CESSNA
MODEL U206G

be recycled since an over-voltage condition has not occurred to de-activate the alternator system.

1. Avionics Power Switch -- OFF.
2. Alternator Circuit Breaker -- CHECK IN.
3. Master Switch -- OFF (both sides).
4. Master Switch -- ON.
5. Low-Voltage Light -- CHECK OFF.
6. Avionics Power Switch -- ON.

If low-voltage light illuminates again:

7. Alternator -- OFF.
8. Nonessential Radio and Electrical Equipment -- OFF.
9. Flight -- TERMINATE as soon as practical.

AMPLIFIED PROCEDURES

ENGINE FAILURE

If an engine failure occurs during the takeoff run, the most important thing to do is stop the airplane on the remaining runway. Those extra items on the checklist will provide added safety after a failure of this type.

Prompt lowering of the nose to maintain airspeed and establish a glide attitude is the first response to an engine failure after takeoff. In most cases, the landing should be planned straight ahead with only small changes in direction to avoid obstructions. Altitude and airspeed are seldom sufficient to execute a 180° gliding turn necessary to return to the runway. The checklist procedures assume that adequate time exists to secure the fuel and ignition systems prior to touchdown.

After an engine failure in flight, the best glide speed as shown in figure 3-1 should be established as quickly as possible. While gliding toward a suitable landing area, an effort should be made to identify the cause of the failure. If time permits, an engine restart should be attempted as shown in the checklist. If the engine cannot be restarted, a forced landing without power must be completed.

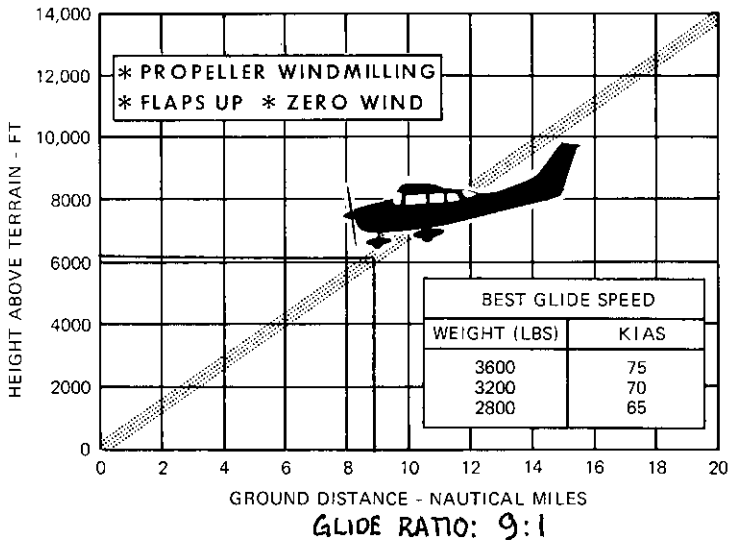

Figure 3-1. Maximum Glide

FORCED LANDINGS

If all attempts to restart the engine fail and a forced landing is imminent, select a suitable field and prepare for the landing as discussed under the Emergency Landing Without Engine Power checklist.

Before attempting an "off airport" landing with engine power available, one should fly over the landing area at a safe but low altitude to inspect the terrain for obstructions and surface conditions, proceeding as discussed under the Precautionary Landing With Engine Power checklist.

Prepare for ditching by securing or jettisoning heavy objects located in the baggage area and collect folded coats for protection of occupants' face at touchdown. Transmit Mayday message on 121.5 MHz giving location and intentions and squawk 7700 if a transponder is installed. Avoid a landing flare because of difficulty in judging height over a water surface.

LANDING WITHOUT ELEVATOR CONTROL

Trim for horizontal flight (with an airspeed of approximately 90 KIAS and flaps set to 20°) by using throttle and trim tab controls. **Then do not change the trim tab setting** and control the glide angle by adjusting power exclusively.

At flareout, the nose-down moment resulting from power reduction is an adverse factor and the airplane may hit on the nose wheel. Consequently, at flareout, the trim tab should be set at full nose-up position and the power adjusted so that the airplane will rotate to the horizontal attitude for touchdown. Close the throttle at touchdown.

FIRES

Improper starting procedures such as excessive use of the auxiliary fuel pump during a cold weather start can cause a backfire which could ignite fuel that has accumulated in the intake duct. In this event, follow the prescribed checklist.

Although engine fires are extremely rare in flight, the steps of the appropriate checklist should be followed if one is encountered. After completion of this procedure, execute a forced landing. Do not attempt to restart the engine.

The initial indication of an electrical fire is usually the odor of burning insulation. The checklist for this problem should result in elimination of the fire.

EMERGENCY OPERATION IN CLOUDS (Vacuum System Failure)

In the event of a vacuum system failure during flight, the directional indicator and attitude indicator will be disabled, and the pilot will have to rely on the turn coordinator or the turn and bank indicator if he inadvertently flies into clouds. The following instructions assume that only the electrically-powered turn coordinator or the turn and bank indicator is operative, and that the pilot is not completely proficient in instrument flying.

EXECUTING A 180° TURN IN CLOUDS

Upon inadvertently entering the clouds, an immediate plan should be made to turn back as follows:

1. Note the compass heading.
2. Note the time of the minute hand and observe the position of the sweep second hand on the clock.
3. When the sweep second hand indicates the nearest half-minute, initiate a standard rate left turn, holding the turn coordinator symbolic airplane wing opposite the lower left index mark for 60 seconds. Then roll back to level flight by leveling the miniature airplane.
4. Check accuracy of the turn by observing the compass heading which should be the reciprocal of the original heading.
5. If necessary, adjust heading primarily with skidding motions rather than rolling motions so that the compass will read more accurately.
6. Maintain altitude and airspeed by cautious application of elevator control. Avoid overcontrolling by keeping hands off the control wheel as much as possible and steering only with rudder.

EMERGENCY DESCENT THROUGH CLOUDS

If conditions preclude reestablishment of VFR flight by a 180° turn, a descent through a cloud deck to VFR conditions may be appropriate. If possible, obtain radio clearance for an emergency descent through clouds. To guard against a spiral dive, choose an easterly or westerly heading to minimize compass card swings due to changing bank angles. In addition, keep hands off the control wheel and steer a straight course with rudder control by monitoring the turn coordinator. Occasionally check the compass heading and make minor corrections to hold an approximate course. Before descending into the clouds, set up a stabilized let-down condition as follows:

1. Reduce power to set up a 500 to 800 ft./min. rate of descent.
2. Apply full rich mixture.
3. Adjust the elevator and rudder trim control wheels for a stabilized descent at 95 KIAS.
4. Keep hands off control wheel.
5. Monitor turn coordinator and make corrections by rudder alone.
6. Adjust rudder trim to relieve unbalanced rudder force, if present.
7. Check trend of compass card movement and make cautious corrections with rudder to stop turn.
8. Upon breaking out of clouds, resume normal cruising flight.

RECOVERY FROM A SPIRAL DIVE

If a spiral is encountered, proceed as follows:

1. Close the throttle.
2. Stop the turn by using coordinated aileron and rudder control to align the symbolic airplane in the turn coordinator with the horizon reference line.
3. Cautiously apply control wheel back pressure to slowly reduce the indicated airspeed to 95 KIAS.
4. Adjust the elevator trim control to maintain a 95 KIAS glide.
5. Keep hands off the control wheel, using rudder control to hold a straight heading. Use rudder trim to relieve unbalanced rudder force, if present.
6. Clear engine occasionally, but avoid using enough power to disturb the trimmed glide.
7. Upon breaking out of clouds, resume normal cruising flight.

INADVERTENT FLIGHT INTO ICING CONDITIONS

Flight into icing conditions is prohibited. An inadvertent encounter with these conditions can best be handled using the checklist procedures. The best procedure, of course, is to turn back or change altitude to escape icing conditions.

STATIC SOURCE BLOCKED

If erroneous readings of the static source instruments (airspeed, altimeter and vertical speed) are suspected, the alternate static source valve should be pulled on, thereby supplying static pressure to these instruments from the cabin.

NOTE

In an emergency on airplanes not equipped with an

alternate static source, cabin pressure can be supplied to the static pressure instruments by breaking the glass in the face of the vertical speed indicator.

With the alternate static source on, adjust indicated airspeed slightly during climb or approach according to the alternate static source airspeed calibration table in Section 5.

SPINS

Intentional spins are prohibited in this airplane. Should an inadvertent spin occur, the following recovery procedure should be used:

1. RETARD THROTTLE TO IDLE POSITION.
2. PLACE AILERONS IN NEUTRAL POSITION.
3. APPLY AND **HOLD** FULL RUDDER OPPOSITE TO THE DIRECTION OF ROTATION.
4. **JUST AFTER** THE RUDDER REACHES THE STOP, MOVE THE CONTROL WHEEL **BRISKLY** FORWARD FAR ENOUGH TO BREAK THE STALL. Full down elevator may be required at aft center of gravity loadings to assure optimum recoveries.
5. **HOLD** THESE CONTROL INPUTS UNTIL ROTATION STOPS. Premature relaxation of the control inputs may extend the recovery.
6. AS ROTATION STOPS, NEUTRALIZE RUDDER, AND MAKE A SMOOTH RECOVERY FROM THE RESULTING DIVE.

NOTE

If disorientation precludes a visual determination of the direction of rotation, the symbolic airplane in the turn coordinator or the needle of the turn and bank indicator may be referred to for this information.

ROUGH ENGINE OPERATION OR LOSS OF POWER

SPARK PLUG FOULING

A slight engine roughness in flight may be caused by one or more spark plugs becoming fouled by carbon or lead deposits. This may be verified by turning the ignition switch momentarily from BOTH to either L or R position. An obvious power loss in single ignition operation is

evidence of spark plug or magneto trouble. Assuming that spark plugs are the more likely cause, lean the mixture to the recommended lean setting for cruising flight. If the problem does not clear up in several minutes, determine if a richer mixture setting will produce smoother operation. If not, proceed to the nearest airport for repairs using the BOTH position of the ignition switch unless extreme roughness dictates the use of a single ignition position.

MAGNETO MALFUNCTION

A sudden engine roughness or misfiring is usually evidence of magneto problems. Switching from BOTH to either L or R ignition switch position will identify which magneto is malfunctioning. Select different power settings and enrichen the mixture to determine if continued operation on BOTH magnetos is practicable. If not, switch to the good magneto and proceed to the nearest airport for repairs.

ENGINE-DRIVEN FUEL PUMP FAILURE

Failure of the engine-driven fuel pump will be evidenced by a sudden reduction in the fuel flow indication **prior to a loss of power**, while operating from a fuel tank containing adequate fuel.

In the event of an engine-driven fuel pump failure during takeoff, immediately hold the left half of the auxiliary fuel pump switch in the HI position until the airplane is well clear of obstacles. Upon reaching a safe altitude, and reducing the power to a cruise setting, release the HI side of the switch. The ON position will then provide sufficient fuel flow to maintain engine operation while maneuvering for a landing.

If an engine-driven fuel pump failure occurs during cruising flight, apply full rich mixture and hold the left half of the auxiliary fuel pump switch in the HI position to re-establish fuel flow. Then the normal ON position (the right half of the fuel pump switch) may be used to sustain level flight. If necessary, additional fuel flow is obtainable by holding the left half of the pump switch in the HI position.

LOW OIL PRESSURE

If low oil pressure is accompanied by normal oil temperature, there is a possibility the oil pressure gage or relief valve is malfunctioning. A leak in the line to the gage is not necessarily cause for an immediate precautionary landing because an orifice in this line will prevent a sudden loss of oil from the engine sump. However, a landing at the nearest airport would be advisable to inspect the source of trouble.

If a total loss of oil pressure is accompanied by a rise in oil tempera-

ture, there is good reason to suspect that an engine failure is imminent. Reduce engine power immediately and select a suitable forced landing field. Use only the minimum power required to reach the desired touch-down spot.

ELECTRICAL POWER SUPPLY SYSTEM MALFUNCTIONS

Malfunctions in the electrical power supply system can be detected by periodic monitoring of the ammeter and low-voltage warning light; however, the cause of these malfunctions is usually difficult to determine. A broken alternator drive belt or wiring is most likely the cause of alternator failures, although other factors could cause the problem. A damaged or improperly adjusted alternator control unit can also cause malfunctions. Problems of this nature constitute an electrical emergency and should be dealt with immediately. Electrical power malfunctions usually fall into two categories: excessive rate of charge and insufficient rate of charge. The paragraphs below describe the recommended remedy for each situation.

EXCESSIVE RATE OF CHARGE

After engine starting and heavy electrical usage at low engine speeds (such as extended taxiing) the battery condition will be low enough to accept above normal charging during the initial part of a flight. However, after thirty minutes of cruising flight, the ammeter should be indicating less than two needle widths of charging current. If the charging rate were to remain above this value on a long flight, the battery would overheat and evaporate the electrolyte at an excessive rate.

Electronic components in the electrical system can be adversely affected by higher than normal voltage. The alternator control unit includes an over-voltage sensor which normally will automatically shut down the alternator if the charge voltage reaches approximately 31.5 volts. If the over-voltage sensor malfunctions or is improperly adjusted, as evidenced by an excessive rate of charge shown on the ammeter, the alternator should be turned off, alternator circuit breaker pulled, non-essential electrical equipment turned off and the flight terminated as soon as practical.

INSUFFICIENT RATE OF CHARGE

NOTE

Illumination of the low-voltage light and ammeter discharge indications may occur during low RPM conditions

with an electrical load on the system, such as during a low RPM taxi. Under these conditions, the light will go out at higher RPM. The master switch need not be recycled since an over-voltage condition has not occurred to de-activate the alternator system.

If the over-voltage sensor should shut down the alternator, or if the alternator circuit breaker should trip, a discharge rate will be shown on the ammeter followed by illumination of the low-voltage warning light. Since this may be a "nuisance" trip-out, an attempt should be made to reactivate the alternator system. To do this, turn the avionics power switch off, check that the alternator circuit breaker is in, then turn both sides of the master switch off and then on again. If the problem no longer exists, normal alternator charging will resume and the low-voltage light will go off. The avionics power switch may then be turned back on. If the light illuminates again, a malfunction is confirmed. In this event, the flight should be terminated and/or the current drain on the battery minimized because the battery can supply the electrical system for only a limited period of time. If the emergency occurs at night, power must be conserved for later use of the landing lights and flaps during landing.

CARGO DOOR EMERGENCY EXIT

If it is necessary to use the cargo doors as an emergency exit and the wing flaps are not extended, open the forward door and exit. If the wing flaps are extended, open the doors in accordance with the instructions shown on the placard which is mounted on the forward cargo door.

SECTION 4

NORMAL PROCEDURES

TABLE OF CONTENTS

	Page
Introduction	4-3
Speeds For Normal Operation	4-3

CHECKLIST PROCEDURES

Preflight Inspection	4-5
Cabin	4-5
Empennage	4-5
Right Wing, Trailing Edge	4-6
Right Wing	4-6
Nose	4-6
Left Wing	4-6
Left Wing, Leading Edge	4-7
Left Wing, Trailing Edge	4-7
Before Starting Engine	4-7
Starting Engine	4-7
Before Takeoff	4-8
Takeoff	4-9
Normal Takeoff	4-9
Short Field Takeoff	4-9
Enroute Climb	4-9
Normal Climb	4-9
Maximum Performance Climb	4-9
Cruise	4-10
Descent	4-10
Before Landing	4-10
Landing	4-10
Normal Landing	4-10
Short Field Landing	4-10
Balked Landing	4-11
After Landing	4-11
Securing Airplane	4-11

TABLE OF CONTENTS (Continued)

	Page
AMPLIFIED PROCEDURES	
Starting Engine	4-13
Taxiing	4-14
Before Takeoff	4-14
Warm-Up	4-14
Magnetos Check	4-14
Alternator Check	4-16
Takeoff	4-16
Power Check	4-16
Wing Flap Settings	4-16
Crosswind Takeoff	4-17
Enroute Climb	4-17
Cruise	4-17
Leaning With A Cessna Economy Mixture Indicator (EGT)	4-19
Stalls	4-20
Landings	4-20
Short Field Landing	4-20
Crosswind Landing	4-20
Balked Landing	4-20
Cold Weather Operation	4-21
Hot Weather Operation	4-21
Flight With Cargo Doors Removed	4-21
Noise Abatement	4-22

INTRODUCTION

Section 4 provides checklist and amplified procedures for the conduct of normal operation. Normal procedures associated with optional systems can be found in Section 9.

SPEEDS FOR NORMAL OPERATION

Unless otherwise noted, the following speeds are based on a maximum weight of 3600 pounds and may be used for any lesser weight. However, to achieve the performance specified in Section 5 for takeoff distance and climb performance, the speed appropriate to the particular weight must be used.

Takeoff:

Normal Climb Out	70-80 KIAS
Short Field Takeoff, Flaps 20°, Speed at 50 Feet65 KIAS

Enroute Climb, Flaps Up:

Normal90-100 KIAS
Best Rate of Climb, Sea Level84 KIAS
Best Rate of Climb, 10,000 Feet78 KIAS
Best Angle of Climb, Sea Level66 KIAS
Best Angle of Climb, 10,000 Feet70 KIAS

Landing Approach:

Normal Approach, Flaps Up	75-85 KIAS
Normal Approach, Flaps 40°	65-75 KIAS
Short Field Approach, Flaps 40°64 KIAS

Balked Landing:

Maximum Power, Flaps 20°80 KIAS
------------------------------------	----------

Maximum Recommended Turbulent Air Penetration Speed:

3600 Lbs	120 KIAS
2900 Lbs	106 KIAS
2200 Lbs93 KIAS

Maximum Demonstrated Crosswind Velocity:

Takeoff or Landing20 KNOTS
------------------------------	-----------

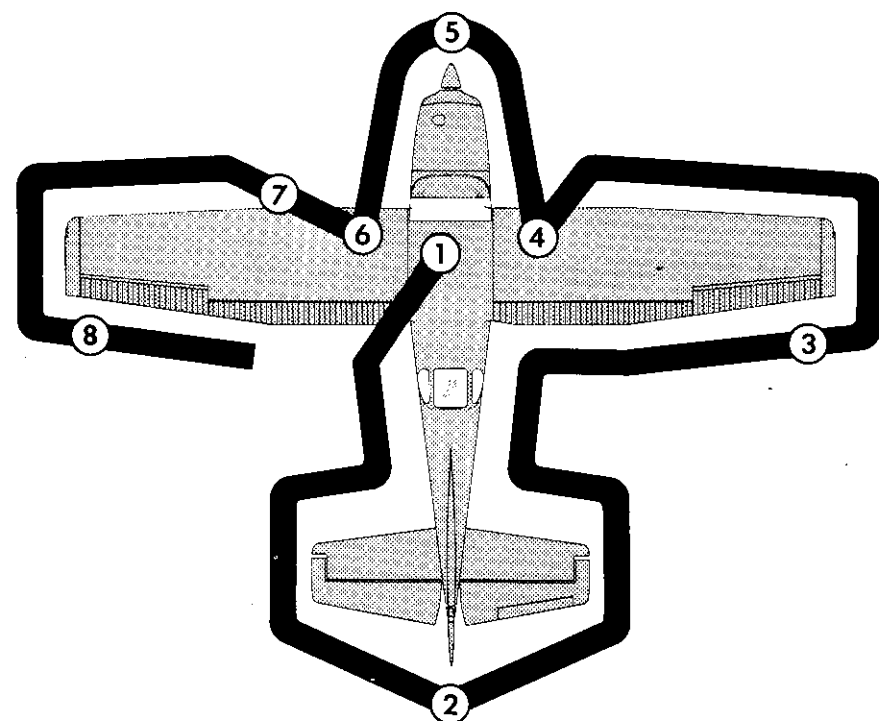

NOTE

Visually check airplane for general condition during walk-around inspection. In cold weather, remove even small accumulations of frost, ice or snow from wing, tail and control surfaces. Also, make sure that control surfaces contain no internal accumulations of ice or debris. Prior to flight, check that pitot heater (if installed) is warm to touch within 30 seconds with battery and pitot heat switches on. If a night flight is planned, check operation of all lights, and make sure a flashlight is available.

Figure 4-1. Preflight Inspection

CHECKLIST PROCEDURES

PREFLIGHT INSPECTION

① CABIN

1. Pilot's Operating Handbook -- AVAILABLE IN THE AIRPLANE.
2. Control Wheel Lock -- REMOVE.
3. Ignition Switch -- OFF.
4. Avionics Power Switch -- OFF.
5. Master Switch -- ON.

WARNING

When turning on the master switch, using an external power source, or pulling the propeller through by hand, treat the propeller as if the ignition switch were on. Do not stand, nor allow anyone else to stand, within the arc of the propeller, since a loose or broken wire, or a component malfunction, could cause the propeller to rotate.

6. Fuel Quantity Indicators -- CHECK QUANTITY.
7. Master Switch -- OFF.
8. Fuel Selector Valve -- FULLER TANK.
9. Trim Controls -- NEUTRAL.
10. Static Pressure Alternate Source Valve (if installed) -- OFF.

② EMPENNAGE

1. Rudder Gust Lock -- REMOVE.
2. Tail Tie-Down -- DISCONNECT.
3. Control Surfaces -- CHECK freedom of movement and security.
4. Check cargo doors securely latched and locked (right side only). If cargo load will not permit access to the front cargo door inside handle, lock the door from the outside by pulling the handle from its recess, pulling outboard on the vertical tab behind the handle, and pushing the handle back into its recess. Door locking can be verified by observing that the inside door handle has rotated toward the locked position. The outside handle can then be locked using the key.

NOTE

The cargo doors must be fully closed and latched before

operating the electric wing flaps. A switch in the upper door sill of the front cargo door interrupts the wing flap electrical circuit when the front door is opened or removed, thus preventing the flaps being lowered with possible damage to the cargo door or wing flaps when the cargo door is open. If operating with the cargo doors removed and the optional spoiler kit installed, check that the wing flap interrupt switch cover plate is installed so that the wing flaps can be lowered in flight.

③ RIGHT WING Trailing Edge

1. Aileron -- CHECK freedom of movement and security.

④ RIGHT WING

1. Wing Tie-Down -- DISCONNECT.
2. Fuel Tank Vent -- CHECK for stoppage.
3. Main Wheel Tire -- CHECK for proper inflation.
4. Before first flight of the day and after each refueling, use sampler cup and drain small quantity of fuel from fuel tank sump quick-drain valve to check for water, sediment, and proper fuel grade.
5. Fuel Quantity -- CHECK VISUALLY for desired level.
6. Fuel Filler Cap -- SECURE and vent unobstructed.

⑤ NOSE

1. Static Source Opening (both sides of fuselage) -- CHECK for stoppage.
2. Propeller and Spinner -- CHECK for nicks, security and oil leaks.
3. Landing and Taxi Lights -- CHECK for condition and cleanliness.
4. Nose Wheel Strut and Tire -- CHECK for proper inflation.
5. Nose Tie-Down -- DISCONNECT.
6. Engine Oil Level -- CHECK, do not operate with less than nine quarts. Fill to twelve quarts for extended flight.
7. Before first flight of the day and after each refueling, pull out strainer drain knob for about four seconds to clear fuel strainer of possible water and sediment. Check strainer drain closed. If water is observed, the fuel system may contain additional water, and further draining of the system at the strainer, fuel tank sumps and reservoirs will be necessary.

⑥ LEFT WING

1. Main Wheel Tire -- CHECK for proper inflation.
2. Before first flight of the day and after each refueling, use sampler cup and drain small quantity of fuel from fuel tank sump quick-

drain valve to check for water, sediment and proper fuel grade.

3. Fuel Quantity -- CHECK VISUALLY for desired level.
4. Fuel Filler Cap -- SECURE and vent unobstructed.

⑦ LEFT WING Leading Edge

1. Pitot Tube Cover -- REMOVE and check opening for stoppage.
2. Stall Warning Vane -- CHECK for freedom of movement while master switch is momentarily turned on (horn should sound when vane is pushed upward).
3. Wing Tie-Down -- DISCONNECT.
4. Fuel Tank Vent -- CHECK for stoppage.

⑧ LEFT WING Trailing Edge

1. Aileron -- CHECK freedom of movement and security.

BEFORE STARTING ENGINE

1. Preflight Inspection -- COMPLETE.
2. Seats, Belts, Shoulder Harnesses -- ADJUST and LOCK.
3. Brakes -- TEST and SET.
4. Cowl Flaps -- OPEN (move lever out of locking hole to reposition).
5. Avionics Power Switch, Autopilot (if installed), Electrical Equipment -- OFF.

CAUTION

The avionics power switch must be OFF during engine start to prevent possible damage to avionics.

6. Master Switch -- ON.
7. Fuel Selector Valve -- FULLER TANK.
8. Circuit Breakers -- CHECK IN.

STARTING ENGINE

1. Mixture -- RICH.
2. Propeller -- HIGH RPM.
3. Throttle -- CLOSED.
4. Auxiliary Fuel Pump -- ON.
5. Throttle -- ADVANCE to obtain 8-10 gal/hr fuel flow, then return to CLOSED position.

6. Auxiliary Fuel Pump -- OFF.
7. Propeller Area -- CLEAR.
8. Ignition Switch -- START.
9. Throttle -- ADVANCE slowly.
10. Ignition Switch -- RELEASE when engine starts.

NOTE

The engine should start in two or three revolutions. If it does not continue running, start again at step 3 above. If the engine does not start, leave auxiliary fuel pump switch off, set mixture to idle cut-off, open throttle, and crank until engine fires or for approximately 15 seconds. If still unsuccessful, start again using the normal starting procedure after allowing the starter motor to cool.

11. Throttle -- IDLE.
12. Oil Pressure -- CHECK.
13. Flashing Beacon and Navigation Lights -- ON as required.
14. Avionics Power Switch -- ON.
15. Radios -- ON.

BEFORE TAKEOFF

1. Parking Brake -- SET.
2. Cabin Doors and Window -- CLOSED and LOCKED.
3. Cowl Flaps -- OPEN.
4. Flight Controls -- FREE and CORRECT.
5. Flight Instruments -- CHECK.
6. Fuel Selector Valve -- FULLER TANK.
7. Mixture -- RICH (below 3000 ft.).
8. Elevator and Rudder Trim -- TAKEOFF setting.
9. Throttle -- 1700 RPM.
 - a. Magnetos -- CHECK (RPM drop should not exceed 150 RPM on either magneto or 50 RPM differential between magnetos).
 - b. Propeller -- CYCLE from high to low RPM; return to high RPM (full forward).
 - c. Engine Instruments and Ammeter -- CHECK.
 - d. Suction Gage -- CHECK (4.6 to 5.4 In. Hg.).
10. Throttle -- 1000 RPM.
11. Radios -- SET.
12. Autopilot (if installed) -- OFF.
13. Strobe Lights -- AS DESIRED.
14. Throttle Friction Lock -- ADJUST.
15. Parking Brake -- RELEASE.

TAKEOFF

NORMAL TAKEOFF

1. Wing Flaps -- 0° - 20°.
2. Power -- FULL THROTTLE and 2850 RPM.
3. Mixture -- LEAN for field elevation per fuel flow placard.
4. Elevator Control -- LIFT NOSE WHEEL at 50 KIAS.
5. Climb Speed -- 70-80 KIAS.
6. Wing Flaps -- RETRACT after obstacles are cleared.

SHORT FIELD TAKEOFF

1. Wing Flaps -- 20°.
2. Brakes -- APPLY.
3. Power -- FULL THROTTLE and 2850 RPM.
4. Mixture -- LEAN for field elevation per fuel flow placard.
5. Brakes -- RELEASE.
6. Elevator Control -- SLIGHTLY TAIL LOW ATTITUDE.
7. Climb Speed -- 65 KIAS until all obstacles are cleared.
8. Wing Flaps -- RETRACT after obstacles are cleared and 80 KIAS is reached.

NOTE

Do not reduce power until wing flaps have been retracted.

ENROUTE CLIMB

NORMAL CLIMB

1. Airspeed -- 90-100 KIAS.
2. Power -- 25 INCHES Hg and 2550 RPM.
3. Mixture -- LEAN to 18.0 gal./hr fuel flow.
4. Cowl Flaps -- OPEN as required.

MAXIMUM PERFORMANCE CLIMB

1. Airspeed -- 84 KIAS at sea level to 78 KIAS at 10,000 feet.
2. Power -- FULL THROTTLE and 2700 RPM.
3. Mixture -- LEAN for altitude per fuel flow placard.
4. Cowl Flaps -- OPEN.

CRUISE

1. Power -- 15-25 INCHES Hg, 2200-2550 RPM (no more than 75%).
2. Mixture -- LEAN for cruise fuel flow as determined from your Cessna Power Computer, or in accordance with the Cruise data in Section 5.
3. Elevator and Rudder Trim -- ADJUST.
4. Cowl Flaps -- AS REQUIRED.

DESCENT

1. Power -- AS DESIRED.
2. Mixture -- LEAN for smoothness in power descents. Use full rich mixture for idle power.
3. Cowl Flaps -- CLOSED.

BEFORE LANDING

1. Fuel Selector Valve -- FULLER TANK.
2. Mixture -- RICH (below 3000 ft.).
3. Propeller -- HIGH RPM.
4. Autopilot (if installed) -- OFF.

LANDING

NORMAL LANDING

1. Airspeed -- 75-85 KIAS (flaps UP).
2. Wing Flaps -- AS DESIRED (0° - 10° below 140 KIAS, 10° - 40° below 100 KIAS).
3. Airspeed -- 65-75 KIAS (flaps DOWN).
4. Elevator Trim -- ADJUST.
5. Touchdown -- MAIN WHEELS FIRST.
6. Landing Roll -- LOWER NOSE WHEEL GENTLY.
7. Braking -- MINIMUM REQUIRED.

SHORT FIELD LANDING

1. Airspeed -- 75-85 KIAS (flaps UP).
2. Wing Flaps -- 40° (below 100 KIAS).
3. Airspeed -- MAINTAIN 64 KIAS.

4. Elevator Trim -- ADJUST.
5. Power -- REDUCE TO IDLE as obstacle is cleared.
6. Touchdown -- MAIN WHEELS FIRST.
7. Brakes -- APPLY HEAVILY.
8. Wing Flaps -- RETRACT for maximum brake effectiveness.

BALKED LANDING

1. Power -- FULL THROTTLE and 2850 RPM.
2. Wing Flaps -- RETRACT to 20°.
3. Airspeed -- 80 KIAS.
4. Wing Flaps -- RETRACT slowly.
5. Cowl Flaps -- OPEN.

AFTER LANDING

1. Wing Flaps -- RETRACT.
2. Cowl Flaps -- OPEN.

SECURING AIRPLANE

1. Parking Brake -- SET.
2. Avionics Power Switch and Electrical Equipment -- OFF.
3. Mixture -- IDLE CUT-OFF (pull full out).
4. Ignition Switch -- OFF.
5. Master Switch -- OFF.
6. Control Lock -- INSTALL.

AMPLIFIED PROCEDURES

STARTING ENGINE

Proper fuel management and throttle adjustments are the determining factors in securing an easy start from your continuous-flow fuel-injection engine. The procedure outlined in this section should be followed closely as it is effective under nearly all operating conditions.

Conventional full rich mixture and high RPM propeller settings are used for starting; the throttle, however, should be fully closed initially. When ready to start, place the auxiliary fuel pump switch in the ON position and advance the throttle to obtain 8-10 gal/hr fuel flow. Then close the throttle and turn off the auxiliary fuel pump. Place the ignition switch in the START position. While cranking, slowly advance the throttle until the engine starts. Slow throttle advancement is essential since the engine will start readily when the correct fuel/air ratio is obtained. When the engine has started, reset the throttle to the desired idle speed.

When the engine is hot or outside air temperatures are high, the engine may die after running several seconds because the mixture became either too lean due to fuel vapor, or too rich due to excessive prime fuel. The following procedure will prevent over-priming and alleviate fuel vapor in the system:

1. Set the throttle 1/3 to 1/2 open.
2. When the ignition switch is on BOTH and you are ready to engage the starter, place the right half of the auxiliary fuel pump switch ON until the indicated fuel flow comes up to 4 to 6 gal/hr; then turn the switch off.

NOTE

During a restart after a brief shutdown in extremely hot weather, the presence of fuel vapor may require the auxiliary fuel pump to operate in the ON position for up to 1 minute or more before the vapor is cleared sufficiently to obtain 4 to 6 gal/hr for starting. If the above procedure does not obtain sufficient fuel flow, fully depress and hold the left half of the switch in the HI position to obtain additional fuel pump capability.

3. Without hesitation, engage the starter and the engine should start in 3 to 5 revolutions. Adjust throttle for 1200 to 1400 RPM.

4. If there is fuel vapor in the lines, it will pass into the injector nozzles in 2 to 3 seconds and the engine will gradually slow down and stop. When engine speed starts to decrease, hold the left half of the auxiliary fuel pump switch in the HI position for approximately one second to clear out the vapor. Intermittent use of HI boost is necessary since prolonged use of the HI position after vapor is cleared will flood out the engine during a starting operation.
5. Let the engine run at 1200 to 1400 RPM until the vapor is eliminated and the engine idles normally.

If prolonged cranking is necessary, allow the starter motor to cool at frequent intervals, since excessive heat may damage the armature.

After starting, if the oil pressure gage does not begin to show pressure within 30 seconds in normal temperatures and 60 seconds in very cold weather, shut off the engine and investigate. Lack of oil pressure can cause serious engine damage.

TAXIING

Taxiing over loose gravel or cinders should be done at low engine speed to avoid abrasion and stone damage to the propeller tips. Refer to figure 4-2 for additional taxiing instructions.

BEFORE TAKEOFF

WARM-UP

Since the engine is closely cowled for efficient in-flight cooling, precautions should be taken to avoid overheating on the ground. Full throttle checks on the ground are not recommended unless the pilot has good reason to suspect that the engine is not turning up properly.

MAGNETO CHECK

The magneto check should be made at 1700 RPM as follows. Move ignition switch first to R position and note RPM. Next move switch back to BOTH to clear the other set of plugs. Then move switch to the L position, note RPM and return the switch to the BOTH position. RPM drop should not exceed 150 RPM on either magneto or show greater than 50 RPM differential between magnetos. If there is a doubt concerning operation of the ignition system, RPM checks at higher engine speeds will usually confirm whether a deficiency exists.

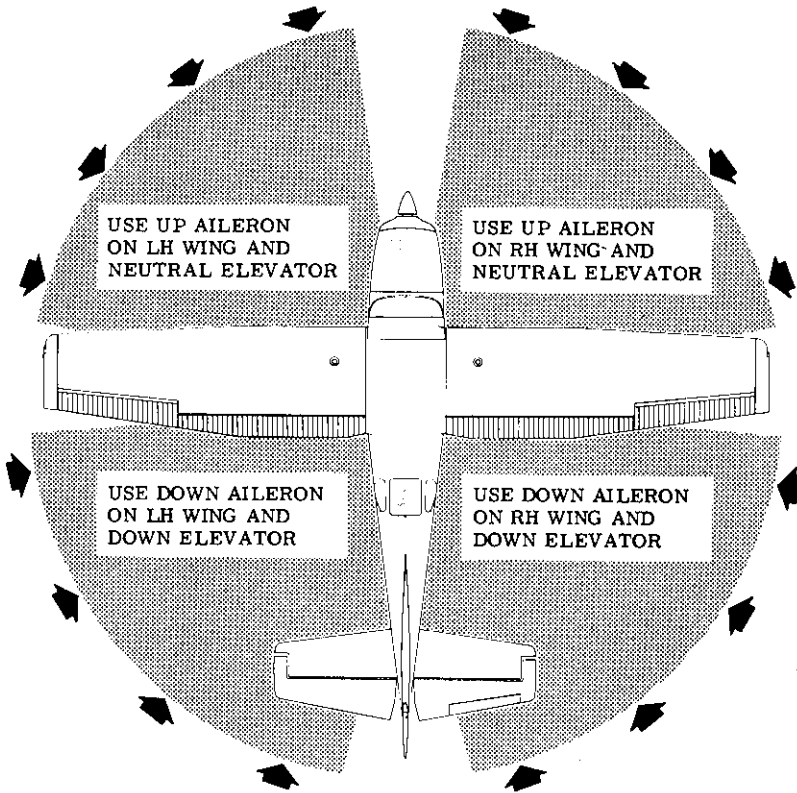

CODE

WIND DIRECTION →

NOTE

Strong quartering tail winds require caution. Avoid sudden bursts of the throttle and sharp braking when the airplane is in this attitude. Use the steerable nose wheel and rudder to maintain direction.

Figure 4-2. Taxiing Diagram

An absence of RPM drop may be an indication of faulty grounding of one side of the ignition system or should be cause for suspicion that the magneto timing is set in advance of the setting specified.

ALTERNATOR CHECK

Prior to flights where verification of proper alternator and alternator control unit operation is essential (such as night or instrument flights), a positive verification can be made by loading the electrical system momentarily (3 to 5 seconds) with the landing light during the engine runup (1700 RPM). The ammeter will remain within a needle width of its original position if the alternator and alternator control unit are operating properly.

TAKEOFF

POWER CHECK

It is important to check takeoff power early in the takeoff run. Any sign of rough engine operation or sluggish engine acceleration is good cause for discontinuing the takeoff.

Full power runups over loose gravel are especially harmful to propeller tips. When takeoffs must be made over a gravel surface, it is very important that the throttle be advanced slowly. This allows the airplane to start rolling before high RPM is developed, and the gravel will be blown back of the propeller rather than pulled into it.

After full power is applied, adjust the throttle friction lock clockwise to prevent the throttle from creeping from a maximum power position. Similar friction lock adjustments should be made as required in other flight conditions to maintain a fixed throttle setting.

For maximum engine power, the mixture should be adjusted during the initial takeoff roll to the fuel flow corresponding to the field elevation. (Refer to the fuel flow placard located adjacent to the fuel flow indicator.) The power increase is significant above 3000 feet and this procedure should always be employed for field elevations greater than 5000 feet above sea level.

WING FLAP SETTINGS

Using 20° wing flaps reduces the ground run and total distance over the obstacle by approximately 10 percent. Soft field takeoffs are performed with 20° flaps by lifting the nose wheel off the ground as soon as practical and leaving the ground in a slightly tail-low attitude. However, the

airplane should be leveled off immediately to accelerate to a safe climb speed.

If 20° wing flaps are used for takeoff, they should be left down until all obstacles are cleared. To clear an obstacle with 20° flaps, a 65 KIAS climb speed should be used. If no obstructions are ahead, a best rate-of-climb speed of 84 KIAS would be most efficient. Flap deflections greater than 20° are not approved for takeoff.

CROSSWIND TAKEOFF

Takeoffs into strong crosswinds normally are performed with the minimum flap setting necessary for the field length, to minimize the drift angle immediately after takeoff. With the ailerons partially deflected into the wind, the airplane is accelerated to a speed slightly higher than normal, and then pulled off abruptly to prevent possible settling back to the runway while drifting. When clear of the ground, make a coordinated turn into the wind to correct for drift.

ENROUTE CLIMB

A cruising climb at 25 inches of manifold pressure, 2550 RPM (approximately 75% power) and 90-100 KIAS is normally recommended. This type of climb provides better engine cooling, less engine wear, and more passenger comfort due to lower noise level, in addition to improved visibility ahead.

Cruising climbs should be conducted at 18 gal/hr up to 4000 feet and then at the fuel flow shown on the normal climb chart in Section 5 for higher altitudes.

If it is necessary to climb rapidly to clear mountains or reach favorable winds at high altitudes, the best rate-of-climb speed should be used with maximum continuous power (full throttle and 2700 RPM). This speed is 84 KIAS at sea level, decreasing to 78 KIAS at 10,000 feet. The mixture should be leaned as shown by the fuel flow placard located adjacent to the fuel flow indicator.

If an obstruction dictates the use of a steep climb angle, climb with flaps retracted and maximum continuous power at 66 KIAS at sea level to 70 KIAS at 10,000 feet.

CRUISE

Normal cruising is performed between 55% and 75% power. The

corresponding power settings and fuel consumption for various altitudes can be determined by using your Cessna Power Computer or the data in Section 5.

NOTE

Cruising should be done at 65% to 75% power until a total of 50 hours has accumulated or oil consumption has stabilized. This is to ensure proper seating of the rings and is applicable to new engines, and engines in service following cylinder replacement or top overhaul of one or more cylinders.

The Cruise Performance Table, figure 4-3, illustrates the advantage of higher altitude on both true airspeed and nautical miles per gallon. In addition, the beneficial effect of lower cruise power on nautical miles per gallon at a given altitude can be observed. This table should be used as a guide, along with the available winds aloft information, to determine the most favorable altitude and power setting for a given trip. The selection of cruise altitude on the basis of the most favorable wind conditions and the use of low power settings are significant factors that should be considered on every trip to reduce fuel consumption.

For reduced noise levels, it is desirable to select the lowest RPM in the green arc range for a given percent power that will provide a comfortable cabin environment and smooth engine operation. The cowl flaps should be opened, if necessary, to maintain the cylinder head temperature at approximately two-thirds of the normal operating range (green arc).

For best fuel economy at 65% power or less, the engine may be operated at one gallon per hour leaner than shown in this handbook and on the power computer. This will result in approximately 6% greater range than

ALTITUDE	75% POWER		65% POWER		55% POWER	
	KTAS	NMPG	KTAS	NMPG	KTAS	NMPG
3000 Feet	142	9.0	134	9.9	124	10.6
6500 Feet	147	9.4	138	10.1	127	10.9
10,000 Feet	---	---	142	10.4	131	11.2
Standard Conditions					Zero Wind	

Figure 4-3. Cruise Performance Table

shown in this handbook accompanied by approximately a 4 knot decrease in speed.

The fuel injection system employed on this engine is considered to be non-icing. In the event that unusual conditions cause the intake air filter to become clogged or iced over, an alternate intake air valve opens automatically for the most efficient use of either normal or alternate air, depending on the amount of filter blockage. Due to the lower intake pressure available through the alternate air valve or a partially blocked filter, full throttle manifold pressure can decrease approximately 1.5 in. Hg.

LEANING WITH A CESSNA ECONOMY MIXTURE INDICATOR (EGT)

Exhaust gas temperature (EGT) as shown on the optional Cessna Economy Mixture Indicator may be used as an aid for mixture leaning in cruising flight at 75% power or less. To adjust the mixture, using this indicator, lean to establish the peak EGT as a reference point and then enrichen the mixture by a desired increment based on the table below.

Continuous operation at peak EGT is authorized only at 65% power or less. This best economy mixture setting results in approximately 6% greater range than shown in this handbook accompanied by approximately a 4 knot decrease in speed.

NOTE

Operation on the lean side of peak EGT is not approved.

When leaning the mixture, if a distinct peak is not obtained, use the corresponding maximum EGT as a reference point for enrichening the mixture to the desired cruise setting. Any change in altitude or power will require a recheck of the EGT indication.

MIXTURE DESCRIPTION	EXHAUST GAS TEMPERATURE
RECOMMENDED LEAN (Pilot's Operating Handbook and Power Computer)	25°F Rich of Peak EGT
BEST ECONOMY (65% Power or Less)	Peak EGT

Figure 4-4. EGT Table

STALLS

The stall characteristics are conventional and aural warning is provided by a stall warning horn which sounds between 5 and 10 knots above the stall in all configurations.

Power-off stall speeds at maximum weight for both forward and aft C.G. are presented in Section 5.

LANDINGS

Landings should be made on the main wheels first to reduce the landing speed and subsequent need for braking in the landing roll. The nose wheel is lowered to the runway after the speed has diminished to avoid unnecessary nose gear load. This procedure is especially important in rough field landings.

SHORT FIELD LANDING

For short field landings, make a power approach at 64 KIAS with full flaps. After all approach obstacles are cleared, progressively reduce power. Maintain 64 KIAS approach speed by lowering the nose of the airplane. Touchdown should be made with the throttle closed, and on the main wheels first. Immediately after touchdown, lower the nose gear and apply heavy braking as required. For maximum brake effectiveness after all three wheels are on the ground, retract the flaps, hold full nose up elevator and apply maximum possible brake pressure without sliding the tires.

At light operating weights, during ground roll with full flaps, hold the control wheel full back to ensure maximum weight on the main wheels for braking. Under these conditions, full nose down elevator (control wheel full forward) will raise the main wheels off the ground.

CROSSWIND LANDING

When landing in a strong crosswind, use the minimum flap setting required for the field length. Although the crab or combination method of drift correction may be used, the wing-low method gives the best control. After touchdown, hold a straight course with the steerable nose wheel and occasional braking if necessary.

BALKED LANDING

In a balked landing (go-around) climb, the wing flap setting should be

reduced to 20° immediately after full power is applied. After all obstacles are cleared and a safe altitude and airspeed are obtained, the wing flaps should be retracted.

COLD WEATHER OPERATION

The use of an external pre-heater and an external power source is recommended whenever possible to reduce wear and abuse to the engine and the electrical system. Pre-heat will thaw the oil trapped in the oil cooler, which probably will be congealed prior to starting in extremely cold temperatures. When using an external power source, the position of the master switch is important. Refer to Section 9, Supplements, for Ground Service Plug Receptacle operating details.

In very cold weather, no oil temperature indication need be apparent before takeoff. After a suitable warm-up period (2 to 5 minutes at 1000 RPM), the engine is ready for takeoff if it accelerates smoothly and the oil pressure is normal and steady.

During let-down, observe engine temperatures closely and carry sufficient power to maintain them in the recommended operating range.

HOT WEATHER OPERATION

The general warm temperature starting information in this section is appropriate. Avoid prolonged engine operation on the ground.

FLIGHT WITH CARGO DOORS REMOVED

When operating with the cargo doors removed, an optional spoiler kit must be installed to minimize strong air flow buffeting within the cabin. In addition, all loose equipment, including head rests, rear window sun shade, removable arm rests, safety belts, etc., should be removed or secured. Fifth and sixth seat passengers will receive a strong air blast, and face protection in the form of goggles or helmet is recommended.

The electric wing flap circuit is interrupted by a push-button switch (mounted on the upper sill of the cargo door opening) when the front cargo door is open or removed. Therefore, to have the use of wing flaps when the

cargo doors are removed, it is necessary to install a switch depressor plate over the door switch button. Two screws secure the plate in position, depressing the switch button. Without this plate, the wing flaps could not be used unless a rear passenger was available to manually depress the door switch button during flap operation.

With the cargo doors removed, flight characteristics are essentially unchanged, except that a slightly different directional trim setting may be needed. With cargo doors removed, do not exceed 130 KIAS.

NOISE ABATEMENT

Increased emphasis on improving the quality of our environment requires renewed effort on the part of all pilots to minimize the effect of airplane noise on the public.

We, as pilots, can demonstrate our concern for environmental improvement, by application of the following suggested procedures, and thereby tend to build public support for aviation:

1. Pilots operating aircraft under VFR over outdoor assemblies of persons, recreational and park areas, and other noise-sensitive areas should make every effort to fly not less than 2000 feet above the surface, weather permitting, even though flight at a lower level may be consistent with the provisions of government regulations.
2. During departure from or approach to an airport, climb after takeoff and descent for landing should be made so as to avoid prolonged flight at low altitude near noise-sensitive areas.

NOTE

The above recommended procedures do not apply where they would conflict with Air Traffic Control clearances or instructions, or where, in the pilot's judgment, an altitude of less than 2000 feet is necessary for him to adequately exercise his duty to see and avoid other aircraft.

The certificated noise level for the Model U206G at 3600 pounds maximum weight is 79.4 dB(A). No determination has been made by the Federal Aviation Administration that the noise levels of this airplane are or should be acceptable or unacceptable for operation at, into, or out of any airport.

SECTION 5 PERFORMANCE

TABLE OF CONTENTS

	Page
Introduction	5-3
Use Of Performance Charts	5-3
Sample Problem	5-3
Takeoff	5-4
Cruise	5-5
Fuel Required	5-5
Landing	5-7
Demonstrated Operating Temperature	5-7
Figure 5-1, Airspeed Calibration	5-9
Figure 5-2, Temperature Conversion Chart	5-10
Figure 5-3, Stall Speeds	5-11
Figure 5-4, Takeoff Distance - 3600 Lbs	5-12
Takeoff Distance - 3300 Lbs And 3000 Lbs	5-13
Figure 5-5, Maximum Rate Of Climb	5-14
Figure 5-6, Time, Fuel, And Distance To Climb - Maximum Rate Of Climb	5-15
Time, Fuel, And Distance To Climb - Normal Climb	5-16
Figure 5-7, Cruise Performance - 2000 Feet	5-17
Cruise Performance - 4000 Feet	5-18
Cruise Performance - 6000 Feet	5-19
Cruise Performance - 8000 Feet	5-20
Cruise Performance - 10,000 Feet	5-21
Cruise Performance - 12,000 Feet	5-22
Cruise Performance - 14,000 Feet	5-23
Figure 5-8, Range Profile - 65 Gallons Fuel	5-24
Range Profile - 88 Gallons Fuel	5-25
Figure 5-9, Endurance Profile - 65 Gallons Fuel	5-26
Endurance Profile - 88 Gallons Fuel	5-27
Figure 5-10, Landing Distance	5-28

INTRODUCTION

Performance data charts on the following pages are presented so that you may know what to expect from the airplane under various conditions, and also, to facilitate the planning of flights in detail and with reasonable accuracy. The data in the charts has been computed from actual flight tests with the airplane and engine in good condition and using average piloting techniques.

It should be noted that the performance information presented in the range and endurance profile charts allows for 45 minutes reserve fuel at the specified cruise power. Fuel flow data for cruise is based on the recommended lean mixture setting. Some indeterminate variables such as mixture leaning technique, fuel metering characteristics, engine and propeller condition, and air turbulence may account for variations of 10% or more in range and endurance. Therefore, it is important to utilize all available information to estimate the fuel required for the particular flight.

USE OF PERFORMANCE CHARTS

Performance data is presented in tabular or graphical form to illustrate the effect of different variables. Sufficiently detailed information is provided in the tables so that conservative values can be selected and used to determine the particular performance figure with reasonable accuracy.

SAMPLE PROBLEM

The following sample flight problem utilizes information from the various charts to determine the predicted performance data for a typical flight. The following information is known:

AIRPLANE CONFIGURATION

Takeoff weight	3550 Pounds
Usable fuel	88 Gallons

TAKEOFF CONDITIONS

Field pressure altitude	1500 Feet
Temperature	28°C (16°C above standard)
Wind component along runway	12 Knot Headwind
Field length	3500 Feet

SECTION 5
PERFORMANCE

CESSNA
MODEL U206G

CRUISE CONDITIONS

Total distance	565 Nautical Miles
Pressure altitude	7500 Feet
Temperature	16°C (16°C above standard)
Expected wind enroute	10 Knot Headwind

LANDING CONDITIONS

Field pressure altitude	2000 Feet
Temperature	25°C
Field length	3000 Feet

TAKEOFF

The takeoff distance chart, figure 5-4, should be consulted, keeping in mind that the distances shown are based on the short field technique. Conservative distances can be established by reading the chart at the next higher value of weight, altitude and temperature. For example, in this particular sample problem, the takeoff distance information presented for a weight of 3600 pounds, pressure altitude of 2000 feet and a temperature of 30°C should be used and results in the following:

Ground roll	1200 Feet
Total distance to clear a 50-foot obstacle	2430 Feet

These distances are well within the available takeoff field length. However, a correction for the effect of wind may be made based on Note 3 of the takeoff chart. The correction for a 12 knot headwind is:

$$\frac{12 \text{ Knots}}{10 \text{ Knots}} \times 10\% = 12\% \text{ Decrease}$$

This results in the following distances, corrected for wind:

Ground roll, zero wind	1200
Decrease in ground roll (1200 feet × 12%)	<u>144</u>
Corrected ground roll	1056 Feet
Total distance to clear a 50-foot obstacle, zero wind	2430
Decrease in total distance (2430 feet × 12%)	<u>292</u>
Corrected total distance to clear a 50-foot obstacle	2138 Feet

CRUISE

The cruising altitude should be selected based on a consideration of trip length, winds aloft, and the airplane's performance. A cruising altitude and the expected wind enroute have been given for this sample problem. However, the power setting selection for cruise must be determined based on several considerations. These include the cruise performance characteristics presented in figure 5-7, the range profile chart presented in figure 5-8, and the endurance profile chart presented in figure 5-9.

The relationship between power and range is illustrated by the range profile chart. Considerable fuel savings and longer range result when lower power settings are used. For this sample problem, a cruise power of approximately 65% will be used.

The cruise performance chart for 8000 feet pressure altitude is entered using 20°C above standard temperature. These values most nearly correspond to the planned altitude and expected temperature conditions. The power setting chosen is 2550 RPM and 21 inches of manifold pressure which results in the following:

Power	65%
True airspeed	142 Knots
Cruise fuel flow	13.6 GPH

The power computer may be used to determine power and fuel consumption more accurately during the flight.

FUEL REQUIRED

The total fuel requirement for the flight may be estimated using the performance information in figures 5-6 and 5-7. For this sample problem, figure 5-6 shows that a normal climb from 2000 feet to 8000 feet at a weight of 3600 pounds requires 3.4 gallons of fuel. The corresponding distance during the climb is 21 nautical miles. These values are for a standard temperature and are sufficiently accurate for most flight planning purposes. However, a further correction for the effect of temperature may be made as noted on the climb chart. The approximate effect of a non-standard temperature is to increase the time, fuel, and distance by 10% for each 10°C above standard temperature, due to the lower rate of climb. In this case, assuming a temperature 16°C above standard, the correction would be:

$$\frac{16^{\circ}\text{C}}{10^{\circ}\text{C}} \times 10\% = 16\% \text{ Increase}$$

SECTION 5
PERFORMANCE

CESSNA
MODEL U206G

With this factor included, the fuel estimate would be calculated as follows:

Fuel to climb, standard temperature	3.4
Increase due to non-standard temperature (3.4 × 16%)	<u>0.5</u>
Corrected fuel to climb	3.9 Gallons

Using a similar procedure for the distance during climb results in 24 nautical miles.

The resultant cruise distance is:

Total distance	565
Climb distance	<u>-24</u>
Cruise distance	541 Nautical Miles

With an expected 10 knot headwind, the ground speed for cruise is predicted to be:

142
<u>-10</u>
132 Knots

Therefore, the time required for the cruise portion of the trip is:

$$\frac{541 \text{ Nautical Miles}}{132 \text{ Knots}} = 4.1 \text{ Hours}$$

The fuel required for cruise is:

$$4.1 \text{ hours} \times 13.6 \text{ gallons/hour} = 55.8 \text{ Gallons}$$

A 45-minute reserve requires:

$$\frac{45}{60} \times 13.6 \text{ gallons/hour} = 10.2 \text{ Gallons}$$

The total estimated fuel required is as follows:

Engine start, taxi, and takeoff	2.0
Climb	3.9
Cruise	55.8
Reserve	<u>10.2</u>
Total fuel required	71.9 Gallons

Once the flight is underway, ground speed checks will provide a more accurate basis for estimating the time enroute and the corresponding fuel required to complete the trip with ample reserve.

LANDING

A procedure similar to takeoff should be used for estimating the landing distance at the destination airport. Figure 5-10 presents landing distance information for the short field technique. The distances corresponding to 2000 feet pressure altitude and a temperature of 30°C are as follows:

Ground roll	830 Feet
Total distance to clear a 50-foot obstacle	1530 Feet

A correction for the effect of wind may be made based on Note 2 of the landing chart using the same procedure as outlined for takeoff.

DEMONSTRATED OPERATING TEMPERATURE

Satisfactory engine cooling has been demonstrated for this airplane with an outside air temperature 23°C above standard. This is not to be considered as an operating limitation. Reference should be made to Section 2 for engine operating limitations.

AIRSPEED CALIBRATION

NORMAL STATIC SOURCE

FLAPS UP													
KIAS	60	70	80	90	100	110	120	130	140	150	160	170	180
KCAS	68	75	82	92	101	110	120	129	139	149	158	168	178
FLAPS 20°													
KIAS	50	60	70	80	90	100	---	---	---	---	---	---	---
KCAS	60	65	73	82	91	101	---	---	---	---	---	---	---
FLAPS 40°													
KIAS	50	60	70	80	90	100	---	---	---	---	---	---	---
KCAS	59	65	73	82	91	101	---	---	---	---	---	---	---

ALTERNATE STATIC SOURCE VENTS AND WINDOWS CLOSED

FLAPS UP													
NORMAL KIAS	60	70	80	90	100	110	120	130	140	150	160	170	180
ALTERNATE KIAS	63	73	82	94	104	114	125	135	145	156	165	176	186
FLAPS 20°													
NORMAL KIAS	50	60	70	80	90	100	---	---	---	---	---	---	---
ALTERNATE KIAS	55	64	74	85	95	105	---	---	---	---	---	---	---
FLAPS 40°													
NORMAL KIAS	50	60	70	80	90	100	---	---	---	---	---	---	---
ALTERNATE KIAS	52	61	71	81	91	102	---	---	---	---	---	---	---

Figure 5-1. Airspeed Calibration

TEMPERATURE CONVERSION CHART

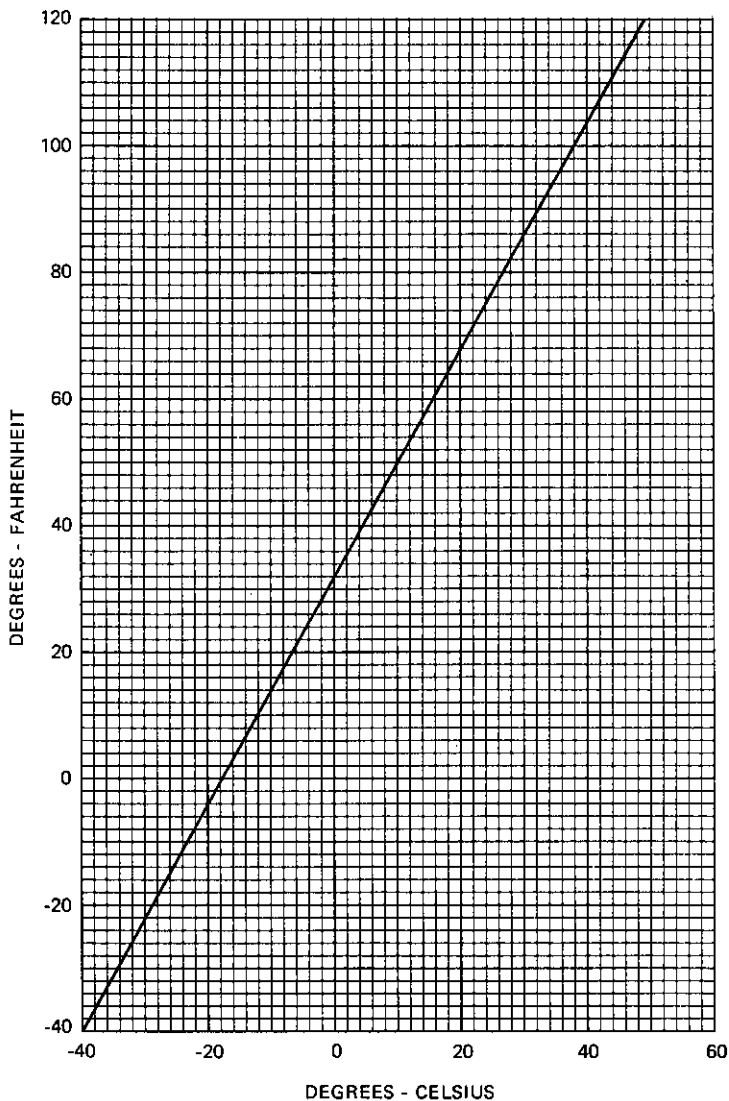

Figure 5-2. Temperature Conversion Chart

STALL SPEEDS

CONDITIONS:
Power Off

NOTES:

1. Maximum altitude loss during a stall recovery may be as much as 240 feet.
2. KIAS values are approximate.

MOST REARWARD CENTER OF GRAVITY

WEIGHT LBS	FLAP DEFLECTION	ANGLE OF BANK							
		0°		30°		45°		60°	
		KIAS	KCAS	KIAS	KCAS	KIAS	KCAS	KIAS	KCAS
3600	UP	41	62	44	67	49	74	58	88
	20°	44	57	47	61	52	68	62	81
	40°	34	54	37	58	40	64	48	76

MOST FORWARD CENTER OF GRAVITY

WEIGHT LBS	FLAP DEFLECTION	ANGLE OF BANK							
		0°		30°		45°		60°	
		KIAS	KCAS	KIAS	KCAS	KIAS	KCAS	KIAS	KCAS
3600	UP	55	67	59	72	65	80	78	95
	20°	50	60	54	65	59	71	71	85
	40°	46	57	49	61	55	68	65	81

Figure 5-3. Stall Speeds

**TAKEOFF DISTANCE
MAXIMUM WEIGHT 3600 LBS**

SHORT FIELD

MIXTURE SETTING	
PRESS ALT	GPH
S.L.	24
2000	23
4000	22
6000	21
8000	20

CONDITIONS:

Flaps 20°
2850 RPM, Full Throttle and Mixture Set at Placard Fuel Flow Prior to Brake Release
Cowl Flaps Open
Paved, Level, Dry Runway
Zero Wind

NOTES:

- Short field technique as specified in Section 4.
- Where distance value has been deleted, climb performance after lift-off is less than 150 fpm at takeoff speed.
- Decrease distances 10% for each 10 knots headwind. For operation with tailwinds up to 10 knots, increase distances by 10% for each 2.5 knots.
- For operation on a dry, grass runway, increase distances by 15% of the "ground roll" figure.

WEIGHT LBS	TAKEOFF SPEED KIAS		PRESS ALT FT	0°C			10°C			20°C			30°C			40°C		
	LIFT OFF	AT 50 FT		GRND ROLL	TO CLEAR 50 FT OBS	TOTAL	GRND ROLL	TO CLEAR 50 FT OBS	TOTAL	GRND ROLL	TO CLEAR 50 FT OBS	TOTAL	GRND ROLL	TO CLEAR 50 FT OBS	TOTAL	GRND ROLL	TO CLEAR 50 FT OBS	
																		50 FT
3600	53	65	S.L.	810	1600	870	1715	935	1845	1000	1985	1075	2135					
			1000	885	1755	950	1890	1020	2035	1095	2190	1175	2365					
			2000	965	1935	1040	2085	1115	2250	1200	2430	1290	2630					
			3000	1060	2140	1140	2310	1225	2500	1320	2710	1415	2945					
			4000	1165	2380	1250	2575	1345	2795	1450	3040	1560	3320					
			5000	1280	2660	1375	2890	1485	3145	1595	3445	1720	3790					
			6000	1410	2995	1520	3270	1635	3580	1765	3950	1900	4390					
			7000	1555	3405	1680	3740	1810	4135	1950	4615	---	---					
8000	1720	3925	1860	4360	2005	4890	---	---	---	---								

Figure 5-4. Takeoff Distance (Sheet 1 of 2)

TAKEOFF DISTANCE

3300 LBS AND 3000 LBS

SHORT FIELD

REFER TO SHEET 1 FOR APPROPRIATE CONDITIONS AND NOTES.

WEIGHT LBS	TAKEOFF SPEED KIAS		PRESS ALT FT	0°C			10°C			20°C			30°C			40°C			
	LIFT OFF	AT 50 FT		GRND ROLL	TO CLEAR 50 FT OBS	TOTAL ROLL	GRND ROLL	TO CLEAR 50 FT OBS	TOTAL ROLL	GRND ROLL	TO CLEAR 50 FT OBS	TOTAL ROLL	GRND ROLL	TO CLEAR 50 FT OBS	TOTAL ROLL	GRND ROLL	TO CLEAR 50 FT OBS	TOTAL ROLL	
3300	51	62	S.L.	660	1305	710	1395	760	1495 ³⁰⁰	815	1605	875	1720	815	1605	875	1720	815	1605
			1000	720	1425	775	1530	830	1640	890	1760	955	1890	890	1760	955	1890	890	1760
	2000	785	1565	845	1675	910	1805	975	1940	1045	2090	1045	2090	1045	2090	1045	2090	1045	2090
	3000	860	1720	925	1845	995	1990	1070	2145	1150	2315	1150	2315	1150	2315	1150	2315	1150	2315
	4000	945	1900	1015	2045	1090	2205	1175	2380	1260	2580	1260	2580	1260	2580	1260	2580	1260	2580
	5000	1035	2105	1115	2270	1200	2455	1290	2660	1390	2890	1390	2890	1390	2890	1390	2890	1390	2890
	6000	1140	2340	1230	2535	1320	2750	1420	2990	1530	3270	1530	3270	1530	3270	1530	3270	1530	3270
	7000	1255	2625	1355	2850	1460	3105	1570	3395	1690	3735	1690	3735	1690	3735	1690	3735	1690	3735
	8000	1385	2960	1495	3235	1610	3545	1735	3910	1870	4345	1870	4345	1870	4345	1870	4345	1870	4345
	3000	48	59	S.L.	530	1050	570	1120	610	1195	655	1280	700	1370	655	1280	700	1370	655
1000				580	1140	620	1220	665	1305	715	1400	765	1500	765	1500	765	1500	765	1500
2000		630	1245	680	1335	730	1430	780	1535	835	1645	835	1645	835	1645	835	1645	835	1645
3000		690	1365	740	1465	795	1570	855	1685	915	1810	915	1810	915	1810	915	1810	915	1810
4000		755	1500	810	1610	870	1725	935	1855	1005	2000	1005	2000	1005	2000	1005	2000	1005	2000
5000		830	1650	890	1775	955	1910	1030	2055	1105	2220	1105	2220	1105	2220	1105	2220	1105	2220
6000		910	1825	980	1965	1050	2115	1130	2285	1215	2475	1215	2475	1215	2475	1215	2475	1215	2475
7000		1000	2025	1075	2185	1160	2360	1245	2555	1340	2775	1340	2775	1340	2775	1340	2775	1340	2775
8000		1100	2260	1185	2445	1275	2650	1375	2880	1480	3140	1480	3140	1480	3140	1480	3140	1480	3140

Figure 5-4. Takeoff Distance (Sheet 2 of 2)

MAXIMUM RATE OF CLIMB

CONDITIONS:

Flaps Up
2700 RPM
Full Throttle
Mixture Set at Placard Fuel Flow
Cowl Flaps Open

MIXTURE SETTING	
PRESS ALT	GPH
S.L.	23
4000	21
8000	19
12,000	17
16,000	15

WEIGHT LBS	PRESS ALT FT	CLIMB SPEED KIAS	RATE OF CLIMB - FPM			
			-20°C	0°C	20°C	40°C
3600	S.L.	84	1080	990	895	805
	2000	83	940	855	770	680
	4000	82	810	725	640	555
	6000	81	680	595	515	430
	8000	79	550	470	390	310
	10,000	78	420	340	265	---
	12,000	77	295	220	145	---
14,000	76	170	95	---	---	
3300	S.L.	82	1235	1145	1050	955
	2000	81	1090	1005	915	825
	4000	79	950	865	780	695
	6000	78	810	730	645	560
	8000	77	675	595	515	435
	10,000	76	540	460	385	---
	12,000	74	410	335	260	---
14,000	73	280	205	---	---	
3000	S.L.	79	1420	1325	1225	1130
	2000	78	1260	1170	1080	985
	4000	77	1110	1025	940	855
	6000	76	965	880	800	715
	8000	74	815	740	655	575
	10,000	73	675	595	520	---
	12,000	71	535	460	385	---
14,000	70	400	330	---	---	

Figure 5-5. Maximum Rate of Climb

TIME, FUEL, AND DISTANCE TO CLIMB

MAXIMUM RATE OF CLIMB

CONDITIONS:

Flaps Up
2700 RPM
Full Throttle
Mixture Set at Placard Fuel Flow
Cowl Flaps Open
Standard Temperature

MIXTURE SETTING	
PRESS ALT	GPH
S.L.	23
4000	21
8000	19
12,000	17
16,000	15

NOTES:

1. Add 2.0 gallons of fuel for engine start, taxi and takeoff allowance.
2. Increase time, fuel and distance by 10% for each 10°C above standard temperature.
3. Distances shown are based on zero wind.

WEIGHT LBS	PRESS ALT FT	CLIMB SPEED KIAS	RATE OF CLIMB FPM	FROM SEA LEVEL		
				TIME MIN	FUEL USED GALLONS	DISTANCE NM
3600	S.L.	84	920	0	0	0
	2000	83	810	2	0.9	3
	4000	82	695	5	1.8	7
	6000	81	585	8	2.9	12
	8000	79	470	12	4.2	18
	10,000	78	360	17	5.7	26
	12,000	77	250	24	7.7	36
	14,000	76	145	35	10.6	54
3300	S.L.	82	1075	0	0	0
	2000	81	955	2	0.7	3
	4000	79	835	4	1.6	6
	6000	78	715	7	2.4	10
	8000	77	600	10	3.4	15
	10,000	76	480	14	4.6	20
	12,000	74	365	19	6.0	28
	14,000	73	250	25	7.9	38
3000	S.L.	79	1250	0	0	0
	2000	78	1125	2	0.6	2
	4000	77	995	4	1.3	5
	6000	76	870	6	2.1	8
	8000	74	740	8	2.9	12
	10,000	73	615	11	3.8	16
	12,000	71	495	15	4.9	22
	14,000	70	375	20	6.2	29

Figure 5-6. Time, Fuel, and Distance to Climb (Sheet 1 of 2)

TIME, FUEL, AND DISTANCE TO CLIMB

NORMAL CLIMB - 95 KIAS

CONDITIONS:

Flaps Up
2550 RPM
25 Inches Hg or Full Throttle
Cowl Flaps Open
Standard Temperature

MIXTURE SETTING	
PRESS ALT	GPH
S.L. to 4000	18
6000	17
8000	16
10,000	15

NOTES:

1. Add 2.0 gallons of fuel for engine start, taxi and takeoff allowance.
2. Increase time, fuel and distance by 10% for each 10°C above standard temperature.
3. Distances shown are based on zero wind.

WEIGHT LBS	PRESS ALT FT	RATE OF CLIMB FPM	FROM SEA LEVEL		
			TIME MIN	FUEL USED GALLONS	DISTANCE NM
3600	S.L.	600	0	0	0
	2000	600	3	1.0	5
	4000	590	7	2.0	11
	6000	480	10	3.1	17
	8000	375	15	4.4	26
	10,000	265	22	6.1	38
3300	S.L.	720	0	0	0
	2000	720	3	0.8	4
	4000	710	6	1.7	9
	6000	595	9	2.6	14
	8000	480	12	3.6	21
	10,000	360	17	4.9	30
3000	S.L.	860	0	0	0
	2000	860	2	0.7	4
	4000	850	5	1.4	8
	6000	725	7	2.1	12
	8000	600	10	3.0	17
	10,000	475	14	4.0	24

Figure 5-6. Time, Fuel, and Distance to Climb (Sheet 2 of 2)

CRUISE PERFORMANCE

PRESSURE ALTITUDE 2000 FEET

CONDITIONS:
3600 Pounds
Recommended Lean Mixture
Cowl Flaps Closed

NOTE
For best fuel economy at 65% power or less, operate at 1 GPH leaner than shown in this chart or at peak EGT if an EGT indicator is installed.

		20°C BELOW STANDARD TEMP -9°C			STANDARD TEMPERATURE 11°C			20°C ABOVE STANDARD TEMP 31°C		
RPM	MP	% BHP	KTAS	GPH	% BHP	KTAS	GPH	% BHP	KTAS	GPH
2550	25	---	---	---	78	143	16.3	76	144	15.8
	24	77	139	16.0	74	140	15.4	71	141	14.9
	23	72	136	15.1	70	137	14.6	67	137	14.1
	22	68	132	14.2	65	133	13.7	63	133	13.3
2500	25	78	140	16.4	76	141	15.8	73	142	15.3
	24	74	137	15.5	72	138	15.0	69	139	14.5
	23	70	134	14.7	68	135	14.2	65	135	13.7
	22	66	131	13.8	64	131	13.4	62	132	12.9
2400	25	73	137	15.3	71	138	14.8	68	138	14.3
	24	69	134	14.5	67	134	14.1	65	135	13.6
	23	66	130	13.8	63	131	13.3	61	131	12.9
	22	62	127	13.0	59	127	12.5	57	128	12.2
2300	25	69	133	14.4	66	134	13.9	64	134	13.5
	24	65	130	13.7	63	130	13.2	61	131	12.8
	23	61	126	12.9	59	127	12.5	57	127	12.1
	22	58	123	12.2	56	123	11.8	54	123	11.5
2200	25	64	128	13.3	61	129	12.9	59	129	12.5
	24	60	125	12.7	58	126	12.3	56	126	11.9
	23	57	122	12.0	55	122	11.6	53	122	11.3
	22	53	119	11.4	51	119	11.0	50	119	10.7
	21	50	115	10.7	48	115	10.4	46	114	10.1
	20	46	110	10.0	45	110	9.7	43	110	9.5

Figure 5-7. Cruise Performance (Sheet 1 of 7)

CRUISE PERFORMANCE

PRESSURE ALTITUDE 4000 FEET

CONDITIONS:
3600 Pounds
Recommended Lean Mixture
Cowl Flaps Closed

NOTE

For best fuel economy at 65% power or less, operate at 1 GPH leaner than shown in this chart or at peak EGT if an EGT indicator is installed.

		20°C BELOW STANDARD TEMP -13°C			STANDARD TEMPERATURE 7°C			20°C ABOVE STANDARD TEMP 27°C		
RPM	MP	% BHP	KTAS	GPH	% BHP	KTAS	GPH	% BHP	KTAS	GPH
2550	24	79	143	16.4	76	144	15.8	73	145	15.3
	23	74	140	15.5	72	141	15.0	69	141	14.5
	22	70	136	14.6	67	137	14.1	65	137	13.7
	21	66	133	13.8	63	133	13.3	61	134	12.9
2500	25	---	---	---	78	145	16.2	75	146	15.7
	24	76	141	15.9	74	142	15.4	71	143	14.9
	23	72	138	15.1	70	139	14.6	67	139	14.1
	22	68	135	14.2	65	135	13.7	63	136	13.3
2400	25	75	140	15.7	72	141	15.1	70	142	14.6
	24	71	137	14.9	69	138	14.4	66	138	13.9
	23	67	134	14.1	65	135	13.6	63	135	13.2
	22	63	130	13.3	61	131	12.9	59	131	12.5
2300	25	70	137	14.7	68	137	14.2	66	138	13.8
	24	67	134	14.0	64	134	13.5	62	135	13.1
	23	63	130	13.3	61	131	12.8	59	131	12.4
	22	59	127	12.5	57	127	12.1	55	127	11.8
2200	25	65	132	13.6	63	132	13.2	61	133	12.8
	24	62	129	13.0	59	129	12.5	57	130	12.2
	23	58	126	12.3	56	126	11.9	54	126	11.6
	22	55	122	11.7	53	122	11.3	51	122	11.0
	21	51	118	11.0	50	118	10.7	48	118	10.4
	20	48	114	10.4	46	114	10.0	45	113	9.8
	19	44	110	9.7	43	109	9.4	41	108	9.1

Figure 5-7. Cruise Performance (Sheet 2 of 7)

CRUISE PERFORMANCE

PRESSURE ALTITUDE 6000 FEET

CONDITIONS:
3600 Pounds
Recommended Lean Mixture
Cowl Flaps Closed

NOTE
For best fuel economy at 65% power or less, operate at 1 GPH leaner than shown in this chart or at peak EGT if an EGT indicator is installed.

		20°C BELOW STANDARD TEMP -17°C			STANDARD TEMPERATURE 3°C			20°C ABOVE STANDARD TEMP 23°C		
RPM	MP	% BHP	KTAS	GPH	% BHP	KTAS	GPH	% BHP	KTAS	GPH
2550	24	---	---	---	78	148	16.2	75	149	15.7
	23	76	144	16.0	74	145	15.4	71	145	14.9
	22	72	141	15.1	69	141	14.5	67	142	14.1
	21	68	137	14.2	65	137	13.7	63	138	13.3
2500	24	78	145	16.3	75	146	15.8	73	147	15.2
	23	74	142	15.5	71	143	14.9	69	143	14.4
	22	70	139	14.6	67	139	14.1	65	140	13.7
	21	66	135	13.8	63	135	13.3	61	136	12.9
2400	24	73	141	15.2	70	142	14.7	68	142	14.2
	23	69	138	14.5	67	138	14.0	64	139	13.5
	22	65	134	13.7	63	135	13.2	61	135	12.8
	21	61	131	12.9	59	131	12.5	57	131	12.1
2300	24	68	137	14.3	66	138	13.8	64	138	13.4
	23	65	134	13.6	62	135	13.1	60	135	12.7
	22	61	130	12.9	59	131	12.4	57	131	12.1
	21	57	127	12.1	55	127	11.8	53	127	11.4
2200	24	63	132	13.3	61	133	12.8	59	133	12.4
	23	60	129	12.6	58	130	12.2	56	130	11.8
	22	57	126	12.0	54	126	11.6	53	126	11.2
	21	53	122	11.3	51	122	11.0	49	122	10.7
	20	50	118	10.7	48	118	10.3	46	117	10.0
	19	46	113	10.0	44	113	9.7	43	112	9.4

Figure 5-7. Cruise Performance (Sheet 3 of 7)

CRUISE PERFORMANCE

PRESSURE ALTITUDE 8000 FEET

CONDITIONS:

3600 Pounds
Recommended Lean Mixture
Cowl Flaps Closed

NOTE

For best fuel economy at 65% power or less, operate at 1 GPH leaner than shown in this chart or at peak EGT if an EGT indicator is installed.

		20°C BELOW STANDARD TEMP -21°C			STANDARD TEMPERATURE -1°C			20°C ABOVE STANDARD TEMP 19°C		
RPM	MP	% BHP	KTAS	GPH	% BHP	KTAS	GPH	% BHP	KTAS	GPH
2550	22	74	145	15.5	71	145	14.9	69	146	14.5
	21	70	141	14.6	67	141	14.1	65	142	13.6
	20	66	137	13.7	63	137	13.3	61	138	12.8
	19	61	133	12.9	59	133	12.4	57	133	12.0
2500	22	72	143	15.0	69	143	14.5	67	144	14.0
	21	68	139	14.2	65	140	13.7	63	140	13.2
	20	63	135	13.3	61	135	12.9	59	136	12.5
	19	59	131	12.5	57	131	12.1	55	131	11.7
2400	22	67	138	14.1	65	139	13.6	62	139	13.1
	21	63	135	13.3	61	135	12.8	59	135	12.4
	20	59	131	12.5	57	131	12.1	55	131	11.7
	19	55	126	11.7	53	126	11.4	51	126	11.0
2300	22	63	134	13.2	61	135	12.8	59	135	12.4
	21	59	131	12.5	57	131	12.1	55	131	11.7
	20	55	127	11.8	53	127	11.4	52	126	11.1
	19	52	122	11.1	50	122	10.7	48	121	10.4
2200	22	58	130	12.3	56	130	11.9	54	130	11.5
	21	55	126	11.6	53	126	11.3	51	126	10.9
	20	51	122	11.0	49	122	10.7	48	121	10.3
	19	48	117	10.3	46	117	10.0	44	116	9.7
	18	44	112	9.7	43	111	9.4	41	110	9.1

Figure 5-7. Cruise Performance (Sheet 4 of 7)

CRUISE PERFORMANCE

PRESSURE ALTITUDE 10,000 FEET

CONDITIONS:

3600 Pounds
Recommended Lean Mixture
Cowl Flaps Closed

NOTE

For best fuel economy at 65% power or less, operate at 1 GPH leaner than shown in this chart or at peak EGT if an EGT indicator is installed.

		20°C BELOW STANDARD TEMP -25°C			STANDARD TEMPERATURE -5°C			20°C ABOVE STANDARD TEMP 15°C		
RPM	MP	% BHP	KTAS	GPH	% BHP	KTAS	GPH	% BHP	KTAS	GPH
2550	20	68	141	14.2	65	142	13.7	63	142	13.2
	19	63	137	13.3	61	137	12.8	59	137	12.4
	18	59	132	12.4	56	132	12.0	55	132	11.6
	17	54	127	11.5	52	127	11.2	50	126	10.8
2500	20	65	139	13.7	63	140	13.3	61	140	12.8
	19	61	135	12.9	59	135	12.4	57	135	12.0
	18	57	130	12.0	55	130	11.6	53	130	11.3
	17	52	125	11.2	50	125	10.8	49	124	10.5
2400	20	61	135	12.9	59	135	12.4	57	135	12.0
	19	57	131	12.1	55	131	11.7	53	130	11.3
	18	53	126	11.3	51	126	11.0	49	125	10.6
	17	49	120	10.6	47	120	10.2	45	119	9.9
2300	20	57	131	12.1	55	131	11.7	53	130	11.4
	19	53	126	11.4	51	126	11.0	50	125	10.7
	18	50	121	10.7	48	121	10.3	46	120	10.0
	17	46	116	9.9	44	115	9.6	42	113	9.3
2200	20	53	126	11.3	51	125	11.0	49	125	10.6
	19	49	121	10.7	48	121	10.3	46	120	10.0
	18	46	116	10.0	44	115	9.7	43	114	9.4

Figure 5-7. Cruise Performance (Sheet 5 of 7)

CRUISE PERFORMANCE

PRESSURE ALTITUDE 12,000 FEET

CONDITIONS:
3600 Pounds
Recommended Lean Mixture
Cowl Flaps Closed

NOTE

For best fuel economy, operate at 1 GPH leaner than shown in this chart or at peak EGT if an EGT indicator is installed.

		20°C BELOW STANDARD TEMP -29°C			STANDARD TEMPERATURE -9°C			20°C ABOVE STANDARD TEMP 11°C		
RPM	MP	% BHP	KTAS	GPH	% BHP	KTAS	GPH	% BHP	KTAS	GPH
2550	18	61	137	12.8	58	137	12.3	56	137	12.0
	17	56	131	11.9	54	131	11.5	52	131	11.2
	16	51	126	11.0	50	125	10.7	48	124	10.3
	15	47	119	10.1	45	118	9.8	43	116	9.5
2500	18	59	134	12.4	57	134	12.0	55	134	11.6
	17	54	129	11.6	52	129	11.2	50	128	10.8
	16	50	123	10.7	48	122	10.4	46	121	10.0
	15	45	116	9.8	43	115	9.5	42	112	9.2
2400	18	55	130	11.7	53	130	11.3	51	129	11.0
	17	51	125	10.9	49	124	10.6	47	123	10.2
	16	47	119	10.1	45	117	9.8	43	115	9.5
2300	18	51	125	11.0	49	125	10.6	48	124	10.3
	17	47	120	10.3	46	119	9.9	44	117	9.6
	16	43	113	9.5	42	111	9.2	40	109	8.9
2200	18	48	120	10.3	46	119	10.0	44	118	9.7
	17	44	114	9.6	42	113	9.3	41	110	9.0

Figure 5-7. Cruise Performance (Sheet 6 of 7)

CRUISE PERFORMANCE

PRESSURE ALTITUDE 14,000 FEET

CONDITIONS:
3600 Pounds
Recommended Lean Mixture
Cowl Flaps Closed

NOTE

For best fuel economy, operate at 1 GPH leaner than shown in this chart or at peak EGT if an EGT indicator is installed.

		20°C BELOW STANDARD TEMP - 33°C			STANDARD TEMPERATURE - 13°C			20°C ABOVE STANDARD TEMP 7°C		
RPM	MP	% BHP	KTAS	GPH	% BHP	KTAS	GPH	% BHP	KTAS	GPH
2550	17	58	136	12.3	56	136	11.9	54	135	11.5
	16	53	130	11.4	51	129	11.0	50	128	10.7
	15	49	123	10.5	47	122	10.1	45	120	9.8
2500	17	56	133	11.9	54	133	11.5	52	133	11.2
	16	52	128	11.1	50	127	10.7	48	125	10.4
	15	47	121	10.2	45	119	9.8	44	117	9.5
2400	17	53	129	11.3	51	128	10.9	49	127	10.5
	16	48	123	10.4	46	122	10.1	45	120	9.8
2300	17	49	124	10.6	47	123	10.2	46	121	9.9
	16	45	117	9.8	43	116	9.5	42	113	9.2
2200	17	46	118	9.9	44	117	9.6	42	114	9.3

Figure 5-7. Cruise Performance (Sheet 7 of 7)

RANGE PROFILE

45 MINUTES RESERVE 65 GALLONS USABLE FUEL

CONDITIONS:

3600 Pounds
Recommended Lean Mixture for Cruise
Standard Temperature
Zero Wind

NOTE:

This chart allows for the fuel used for engine start, taxi, takeoff and climb, and the distance during a normal climb up to 10,000 feet and maximum climb above 10,000 feet.

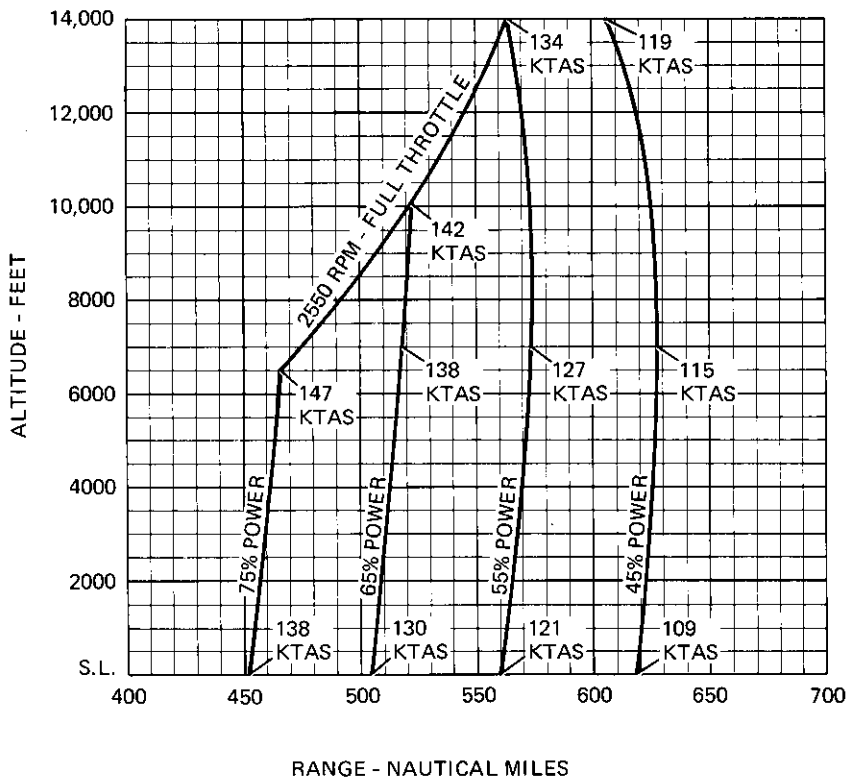

Figure 5-8. Range Profile (Sheet 1 of 2)

RANGE PROFILE

45 MINUTES RESERVE 88 GALLONS USABLE FUEL

CONDITIONS:

3600 Pounds
Recommended Lean Mixture for Cruise
Standard Temperature
Zero Wind

NOTE:

This chart allows for the fuel used for engine start, taxi, takeoff and climb, and the distance during a normal climb up to 10,000 feet and maximum climb above 10,000 feet.

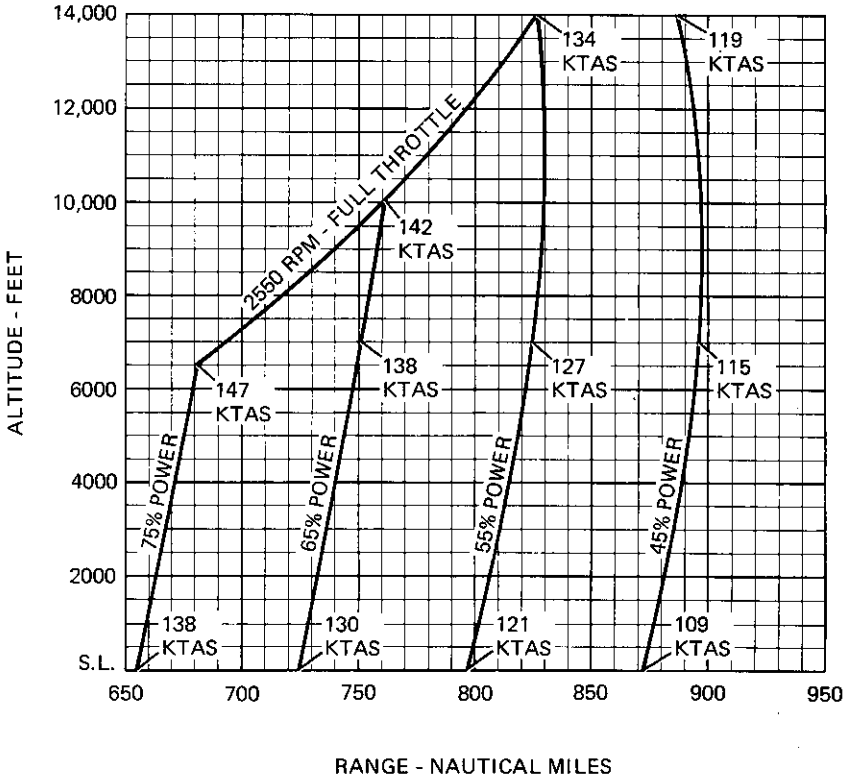

Figure 5-8. Range Profile (Sheet 2 of 2)

ENDURANCE PROFILE

45 MINUTES RESERVE
65 GALLONS USABLE FUEL

CONDITIONS:

3600 Pounds
Recommended Lean Mixture for Cruise
Standard Temperature

NOTE:

This chart allows for the fuel used for engine start, taxi, takeoff and climb, and the time during a normal climb up to 10,000 feet and maximum climb above 10,000 feet.

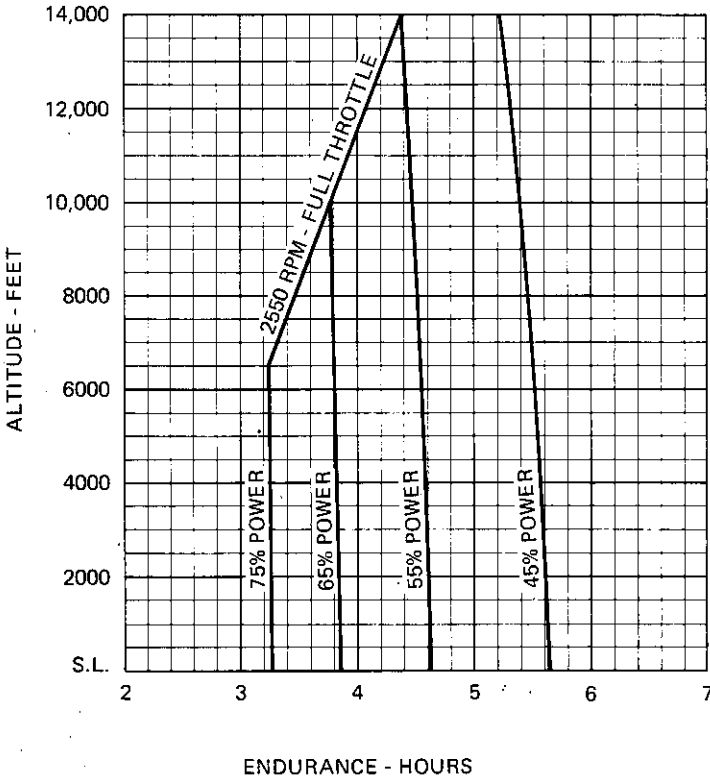

Figure 5-9. Endurance Profile (Sheet 1 of 2)

ENDURANCE PROFILE

45 MINUTES RESERVE 88 GALLONS USABLE FUEL

CONDITIONS:
3600 Pounds
Recommended Lean Mixture for Cruise
Standard Temperature

NOTE:
This chart allows for the fuel used for engine start, taxi, takeoff and climb, and the time during a normal climb up to 10,000 feet and maximum climb above 10,000 feet.

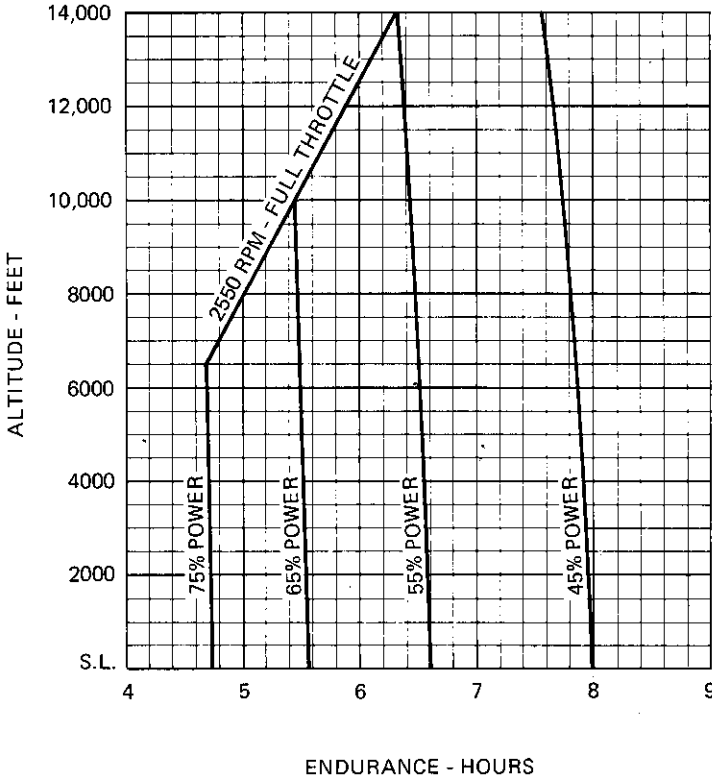

Figure 5-9. Endurance Profile (Sheet 2 of 2)

LANDING DISTANCE

SHORT FIELD

CONDITIONS:

Flaps 40°
Power Off
Maximum Braking
Paved, Level, Dry Runway
Zero Wind

NOTES:

1. Short field technique as specified in Section 4.
2. Decrease distances 10% for each 10 knots headwind. For operation with tailwinds up to 10 knots, increase distances by 10% for each 2.5 knots.
3. For operation on a dry, grass runway, increase distances by 40% of the "ground roll" figure.

WEIGHT LBS	SPEED AT 50 FT KIAS	PRESS ALT FT	0°C			10°C			20°C			30°C			40°C			
			GRND ROLL	TOTAL TO CLEAR 50 FT OBS	GRND ROLL	TOTAL TO CLEAR 50 FT OBS	GRND ROLL	TOTAL TO CLEAR 50 FT OBS	GRND ROLL	TOTAL TO CLEAR 50 FT OBS	GRND ROLL	TOTAL TO CLEAR 50 FT OBS	GRND ROLL	TOTAL TO CLEAR 50 FT OBS				
3600	64	S.L.	695	1340	720	1375	750	1415	750	1415	775	1450	775	1450	800	1490	800	1490
		1000	720	1375	750	1415	775	1455	805	1495	830	1530	830	1530	860	1575	860	1575
		2000	750	1415	775	1455	805	1495	835	1540	865	1580	865	1580	890	1615	890	1615
		3000	775	1455	805	1495	835	1540	865	1580	895	1625	895	1625	925	1665	925	1665
		4000	805	1495	835	1540	870	1585	900	1630	930	1675	930	1675	960	1715	960	1715
		5000	835	1540	870	1585	900	1630	935	1680	965	1725	965	1725	995	1770	995	1770
		6000	870	1590	900	1630	935	1680	970	1730	1000	1775	1000	1775	1035	1825	1035	1825
		7000	905	1635	935	1680	970	1730	1005	1780	1040	1830	1040	1830	1075	1880	1075	1880
8000	940	1690	970	1730	1005	1780	1040	1830	1075	1880	1075	1880	1110	1930	1110	1930		

Figure 5-10. Landing Distance

SECTION 6 WEIGHT & BALANCE/ EQUIPMENT LIST

TABLE OF CONTENTS

	Page
Introduction	6-3
Airplane Weighing Procedures	6-3
Weight And Balance	6-6
Equipment List	6-17

INTRODUCTION

This section describes the procedure for establishing the basic empty weight and moment of the airplane. Sample forms are provided for reference. Procedures for calculating the weight and moment for various operations are also provided. A comprehensive list of all Cessna equipment available for this airplane is included at the back of this section.

It should be noted that specific information regarding the weight, arm, moment and installed equipment list for this airplane can only be found in the appropriate weight and balance records carried in the airplane.

It is the responsibility of the pilot to ensure that the airplane is loaded properly.

AIRPLANE WEIGHING PROCEDURES

1. Preparation:
 - a. Inflate tires to recommended operating pressures.
 - b. Remove the fuel tank sump quick-drain fittings and reservoir tank quick-drain fittings to drain all fuel.
 - c. Remove oil sump drain plug to drain all oil.
 - d. Move sliding seats to the most forward position.
 - e. Raise flaps to the fully retracted position.
 - f. Place all control surfaces in neutral position.
2. Leveling:
 - a. Place scales under each wheel (minimum scale capacity, 1000 pounds).
 - b. Deflate nose tire and/or lower or raise the nose strut to properly center the bubble in the level (see figure 6-1).
3. Weighing:
 - a. With the airplane level and brakes released, record the weight shown on each scale. Deduct the tare, if any, from each reading.
4. Measuring:
 - a. Obtain measurement A by measuring horizontally (along the airplane center line) from a line stretched between the main wheel centers to a plumb bob dropped from the firewall.
 - b. Obtain measurement B by measuring horizontally and parallel to the airplane center line, from center of nose wheel axle, left side, to a plumb bob dropped from the line between the main wheel centers. Repeat on right side and average the measurements.
5. Using weights from item 3 and measurements from item 4, the airplane weight and C.G. can be determined.
6. Basic Empty Weight may be determined by completing figure 6-1.

SECTION 6
WEIGHT & BALANCE/
EQUIPMENT LIST

CESSNA
MODEL U206B

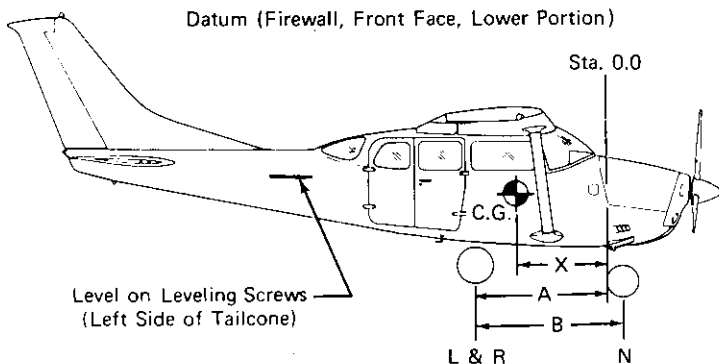

Scale Position	Scale Reading	Tare	Symbol	Net Weight
Left Wheel			L	
Right Wheel			R	
Nose Wheel			N	
Sum of Net Weights (As Weighed)			W	

$$X - \text{ARM} = (A) - \frac{(N) \times (B)}{W}; X = (\quad) - \frac{(\quad) \times (\quad)}{(\quad)} = (\quad) \text{ IN.}$$

Item	Weight (Lbs.)	X C.G. Arm (In.)	Moment/1000 (Lbs.-In.)
Airplane Weight (From Item 5, page 6-3)			
Add Oil:			
No Oil Filter (12 Qts at 7.5 Lbs/Gal)		-19.4	
With Oil Filter (13 Qts at 7.5 Lbs/Gal)		-19.4	
Add: Unusable Fuel (4 Gal at 6 Lbs/Gal)	24.0	48.0	1.2
Equipment Changes			
Airplane Basic Empty Weight			

Figure 6-1. Sample Airplane Weighing

WEIGHT AND BALANCE

The following information will enable you to operate your Cessna within the prescribed weight and center of gravity limitations. To figure weight and balance, use the Sample Problem, Loading Graph, and Center of Gravity Moment Envelope as follows:

Take the basic empty weight and moment from appropriate weight and balance records carried in your airplane, and enter them in the column titled YOUR AIRPLANE on the Sample Loading Problem.

NOTE

In addition to the basic empty weight and moment noted on these records, the C.G. arm (fuselage station) is also shown, but need not be used on the Sample Loading Problem. The moment which is shown must be divided by 1000 and this value used as the moment/1000 on the loading problem.

Use the Loading Graph to determine the moment/1000 for each additional item to be carried; then list these on the loading problem.

NOTE

Loading Graph information for the pilot, passengers and baggage or cargo is based on seats positioned for average occupants and baggage or cargo loaded in the center of these areas as shown on the Loading Arrangements diagram. For loadings which may differ from these, the Sample Loading Problem lists fuselage stations for these items to indicate their forward and aft C.G. range limitation (seat travel or baggage/cargo area limitation). Additional moment calculations, based on the actual weight and C.G. arm (fuselage station) of the item being loaded, must be made if the position of the load is different from that shown on the Loading Graph.

When a cargo pack is installed, it is necessary to determine the C.G. arm and calculate the moment/1000 of items carried in the pack. The arm for any location in the pack can be determined from the diagram on figure 6-5. Multiply the weight of the item by the C.G. arm, then divide by 1000 to get the moment/1000. The maximum loading capacity of the pack is 300 pounds.

NOTE

Each loading should be figured in accordance with the above paragraphs. When the loading is light (such as pilot and copilot, and no rear seats or cargo), be sure to check the forward balance limits. When loading is heavy (near gross weight), be sure to check the aft balance limits.

To avoid time consuming delays in cargo and/or passenger shifting, plan your load so that the heaviest cargo and/or passengers are in the forward part of the airplane or cargo pack, and the lightest in the rear. Always plan to have any vacant space at the rear of the airplane or pack. For example, do not have passengers occupy the aft seat unless the front and center seats are to be occupied.

Total the weights and moments/1000 and plot these values on the Center of Gravity Moment Envelope to determine whether the point falls within the envelope, and if the loading is acceptable.

LOADING ARRANGEMENTS

*Pilot or passenger center of gravity on adjustable seats positioned for average occupant. Numbers in parentheses indicate forward and aft limits of occupant center of gravity range.

**Arms measured to the center of the areas shown.

- NOTES: 1. The usable fuel C.G. arm is located at station 46.5.
2. The aft baggage wall (approximate station 145) can be used as a convenient interior reference point for determining the location of baggage area fuselage stations.

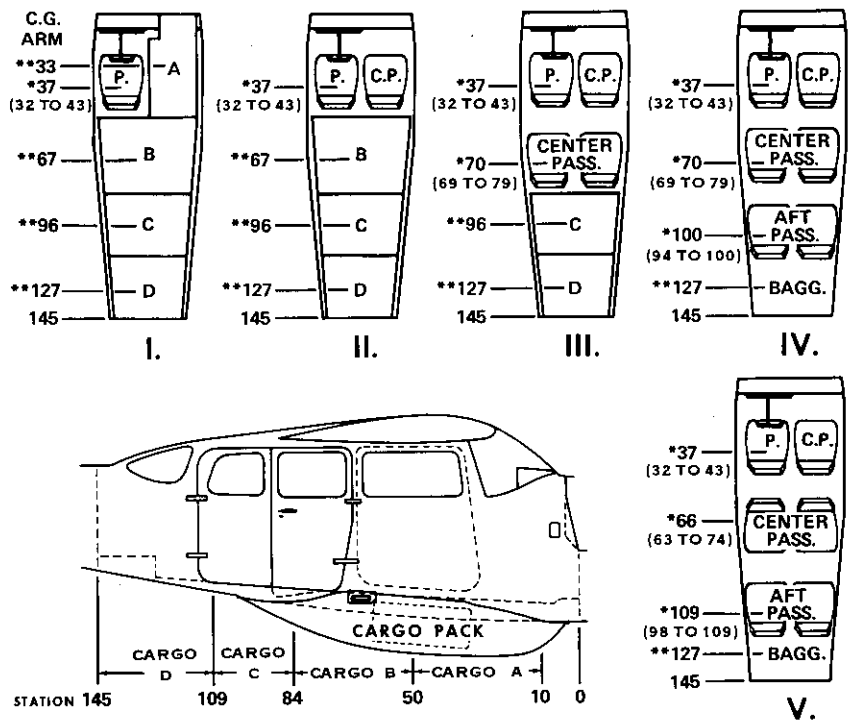

Figure 6-3. Loading Arrangements

Since your Cessna is capable of carrying large amounts of cargo, it will be necessary to properly secure this load before flight. Cargo tie-down blocks which fasten to the seat rails, and "D" rings which fasten to the aft portion of the cabin floor (sta. 124), are available from any Cessna Dealer for airplanes with normal seating and airplanes with club seating. With normal seating, twelve tie-down blocks and three "D" rings may be used. On airplanes equipped with club seating, eight of the twelve tie-down blocks used are designed for use on the larger seat rails installed for the aft facing seats. Care must be taken to ensure that the proper sized tie-down blocks are used. If more tie-down points are needed, the seat belt attaching points, as well as shoulder harness attaching points, may be used. Rope, strap, or cable used for tie-down should be rated at a minimum of ten times the load weight capacity of the tie-down fittings used.

The following table shows the maximum allowable cargo weight for each type of attachment:

ITEM	LOCATION	*MAXIMUM LOAD (LBS)
Seat Rail Tie-Down Assy	On Seat Rail Section Without Lock Pin Holes	200
Seat Rail Tie-Down Assy	On Seat Rail Section With Lock Pin Holes	100
"D" Rings	Floor only	60
Seat Belt Attachment	Floor or Side-Wall	200
Shoulder Strap	Cabin Top	175

*Rated load per attachment (Cargo Item Wt. ÷ No. Tie-Downs). A sufficient number of attachments to restrain the cargo from shifting should be used in addition to load requirements

FOR EXAMPLE:

A 400# load would require a minimum of four (4) tie-downs rated at 100# each.

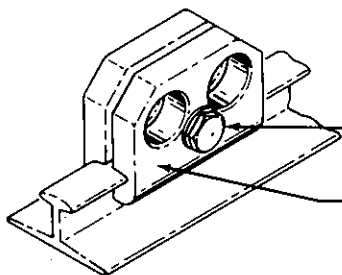

MUST BE TIGHTENED TO A MINIMUM OF 50 INCH POUNDS.

SEAT RAIL TIE-DOWN ASSEMBLY (TWO SIZES REQUIRED FOR CLUB SEATING)

Figure 6-4. Cargo Loading

SECTION 6
WEIGHT & BALANCE/
EQUIPMENT LIST

CESSNA
MODEL U206G

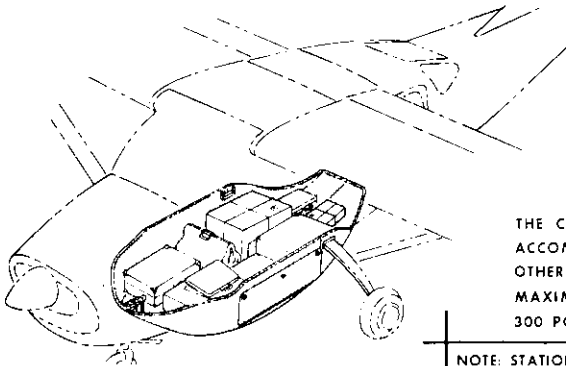
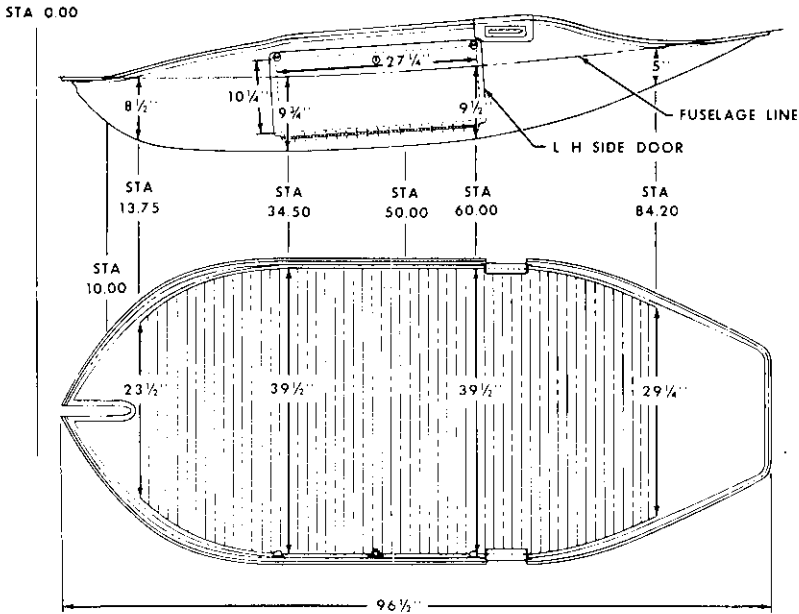

THE CARGO PACK WAS DESIGNED TO ACCOMMODATE THREE "TWO-SUITERS", PLUS OTHER SMALL MISCELLANEOUS ARTICLES. MAXIMUM LOADING FOR CARGO PACK IS 300 POUNDS.

NOTE: STATION LOCATION AND C.G. ARM ARE IDENTICAL

Figure 6-5. Cargo Pack

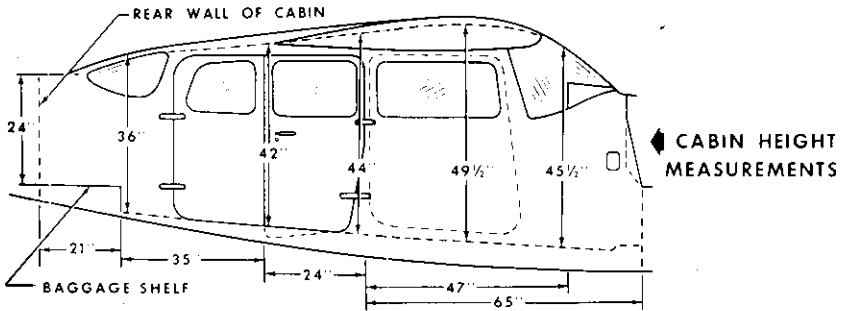

DOOR OPENING DIMENSIONS

WIDTH
* CABIN FLOOR
● LWR WINDOW LINE

	WIDTH (TOP)	WIDTH (BOTTOM)	HEIGHT (FRONT)	HEIGHT (REAR)
CABIN DOOR	32 1/2"	37"	41"	39"
CARGO DOORS	43"	40"	39 1/4"	37 1/2"

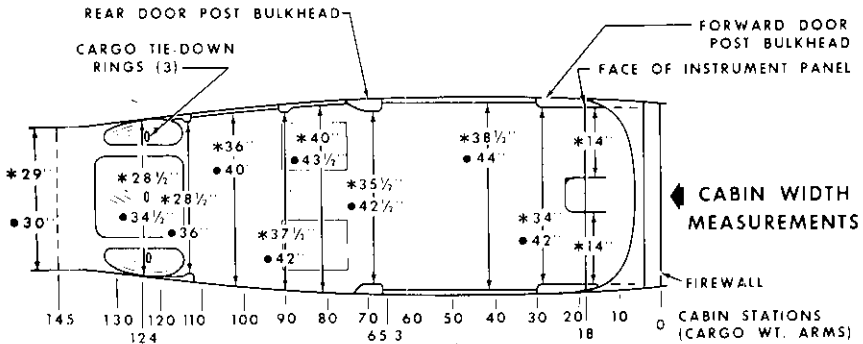

NOTES:

1. Use the forward face of the rear door post as a reference point to locate C. G. arms. For example, a box with its center of weight located 13 inches aft of the rear door post would have a C. G. arm of (65.3-13.0 - 78.3) 78.3 inches.
2. Maximum allowable floor loading: 200 pounds square foot. However, when items with small or sharp support areas are carried, the installation of a 1/4" plywood floor is highly recommended to protect the aircraft structure.

Figure 6-6. Internal Cabin Dimensions

SECTION 6
WEIGHT & BALANCE/
EQUIPMENT LIST

CESSNA
MODEL U206G

SAMPLE LOADING PROBLEM	SAMPLE AIRPLANE		YOUR AIRPLANE	
	Weight (lbs.)	Moment (lb.-ins. /1000)	Weight (lbs.)	Moment (lb.-ins. /1000)
1. Basic Empty Weight (Use the data pertaining to your airplane as it is presently equipped. Includes unusable fuel and full oil)	2019	76.4		
2. Usable Fuel (At 6 Lbs./Gal.) Standard Tanks (88 Gal. Max.)	528	24.6		
Reduced Fuel (65 Gal.)				
3. Pilot and Copilot (Sta. 32 to 43)	340	12.6		
4. Center Passengers Standard Seating (Sta. 69 to 79)	340	23.8		
Club Seating (Sta. 63 to 74)				
Aft Passengers Standard Seating (Sta. 94 to 100)	340	34.0		
Club Seating (Sta. 98 to 109)				
Baggage IV or V (Sta. 109 to 145, 180 Lbs. Max.)	45	5.7		
5. *Cargo "A" (Sta. 10 to 50)				
*Cargo "B" (Sta. 50 to 84)				
*Cargo "C" (Sta. 84 to 109)				
*Cargo "D" (Sta. 109 to 145)				
6. Cargo Pack (Sta. 10 to 84; 300 Lbs. Max.)				
7. RAMP WEIGHT AND MOMENT	3612	177.1		
8. Fuel allowance for engine start, taxi, and runup	-12	-.6		
9. TAKEOFF WEIGHT AND MOMENT (Subtract Step 8 from Step 7)	3600	176.5		
10. Locate this point (3600 at 176.5) on the Center of Gravity Moment Envelope, and since this point falls within the envelope, the loading is acceptable. *Maximum allowable cargo loads will be determined by the type and number of tie-downs used, as well as by the airplane weight and C.G. limitations. Floor loading must not exceed 200 lbs. per square foot.				

Figure 6-7. Sample Loading Problem

SECTION 6
WEIGHT & BALANCE/
EQUIPMENT LIST

CESSNA
MODEL U206G

LOADED AIRPLANE MOMENT/1000 (KILOGRAM - MILLIMETERS)

600 700 800 900 1000 1100 1200 1300 1400 1500 1600 1700 1800 1900 2000 2100

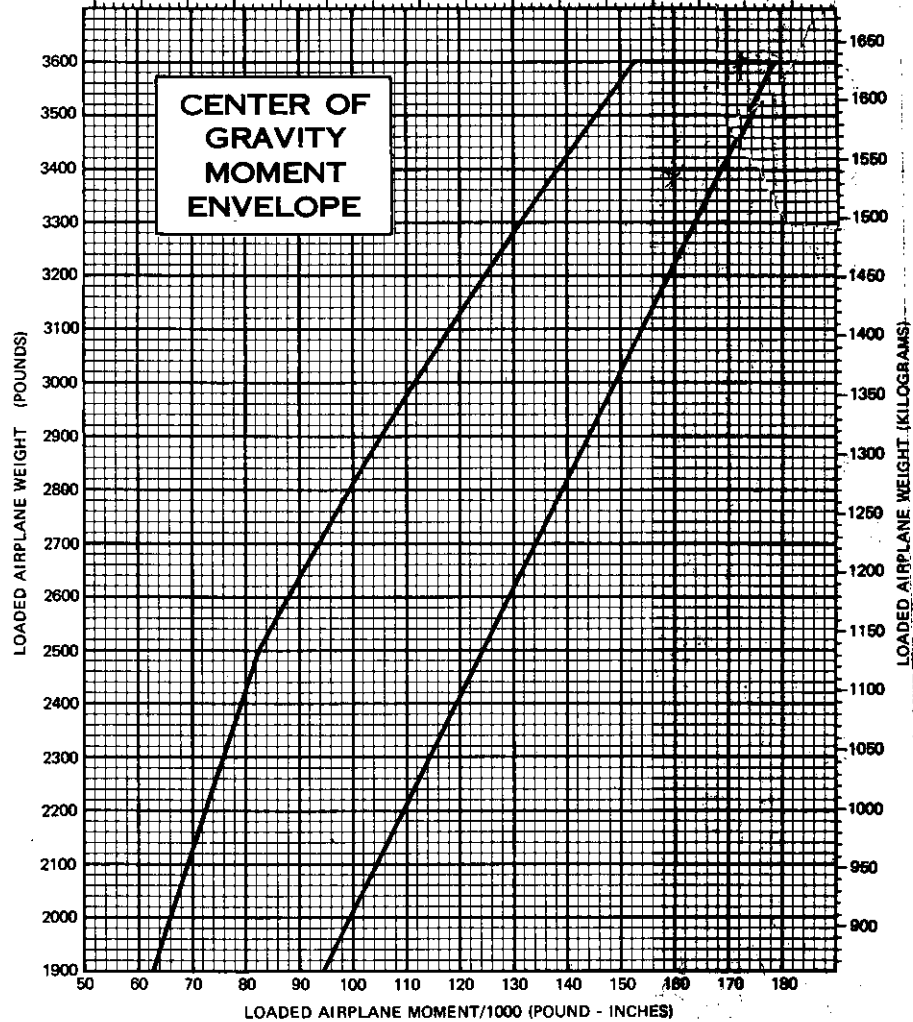

Figure 6-9. Center of Gravity Moment Envelope

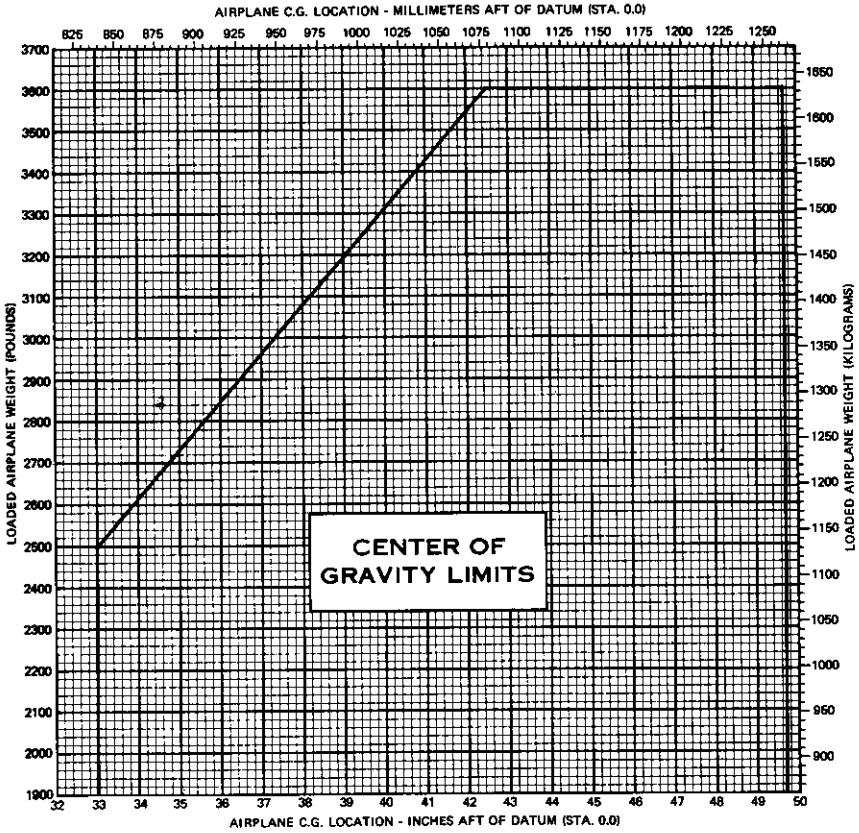

Figure 6-10. Center of Gravity Limits

EQUIPMENT LIST

The following equipment list is a comprehensive list of all Cessna equipment available for this airplane. A separate equipment list of items installed in your specific airplane is provided in your aircraft file. The following list and the specific list for your airplane have a similar order of listing.

This equipment list provides the following information:

An **item number** gives the identification number for the item. Each number is prefixed with a letter which identifies the **descriptive** grouping (example: A. Powerplant & Accessories) under which it is listed. Suffix letters identify the equipment as a required item, a standard item or an optional item. Suffix letters are as follows:

- R = required items of equipment for FAA certification
- S = standard equipment items
- O = optional equipment items replacing required or standard items
- A = optional equipment items which are in addition to required or standard items

A **reference drawing** column provides the drawing number for the item.

NOTE

If additional equipment is to be installed, it must be done in accordance with the reference drawing, accessory kit instructions, or a separate FAA approval.

Columns showing **weight (in pounds)** and **arm (in inches)** provide the weight and center of gravity location for the equipment.

NOTE

Unless otherwise indicated, true values (not net change values) for the weight and arm are shown. Positive arms are distances aft of the airplane datum; negative arms are distances forward of the datum.

NOTE

Asterisks (*) after the item weight and arm indicate complete assembly installations. Some major components of the assembly are listed on the lines immediately following. The summation of these major components does not necessarily equal the complete assembly installation.

SECTION 6
WEIGHT & BALANCE/
EQUIPMENT LIST

CESSNA
MODEL U206G

ITEM NO	EQUIPMENT LIST DESCRIPTION	REF DRAWING	WT LBS	ARM INS
	A. POWERPLANT & ACCESSORIES			
A01-R	ENGINE, CONTINENTAL IO-520-F SPEC. 12 (INCLUDES MAGNETO, OIL COOLER INSTL., SPARK PLUGS & STARTER)	1250601-16	450.0*	-17.0*
A05-R	FILTER, INDUCTION AIR	1250704-3	0.8	-9.5
A09-R	ALTERNATOR, 28 VOLT, 60 AMP	C611503-0102	10.8	-6.0
A17-0	OIL COOLER, NON-CONGEALING (REPLACES OIL COOLER IN ITEM A01-R AND CHANGES ENGINE DESIGNATION TO IO-520-F SPEC 12) (SPIN-ON ELEMENT)	TCM 639171	2.3	-32.5
A21-A	OIL FILTER, ASSEMBLY OIL ADAPTER ASSEMBLY	1656025-3	2.6*	-5.0*
	FILTER ASSEMBLY	1250922-5	1.1	-5.3
	FILTER ASSEMBLY	C294507-0102	1.1	-4.8
A33-R	PROPELLER ASSY, 3-BLADE 80-INCH MCCAULEY HUB/BLADE D3A34C404/80VA-0	C161001-0102	68.6*	-44.0*
A37-R-1	GOVERNOR, PROPELLER (MCCAULEY C290D4/T4)	C161032-0102	3.0	-35.5
A41-R	SPINNER, 3-BLADED PROPELLER	1250419-12	3.5	-44.5
A61-A	VACUUM SYSTEM, ENGINE DRIVEN VACUUM PUMP RELIEF VALVE	1201055-1	3.8*	-2.7*
	MISC. HUBS, CLAMPS ETC.	C482001-0501	0.6	-3.3
	ENGINE PRIMER, 2-POINT MANIFOLD TYPE	1216612-6	0.9	-3.8
A70-A	OIL QUICK DRAIN VALVE (NET CHANGE)	1256011-1	1.0	-8.5
A88-R	AIR INDUCTION SYSTEM	1250702-2	0.5	-2.5
	B. LANDING GEAR & ACCESSORIES			
B01-R-1	WHEEL, BRAKE & TIRE ASSY 6.00-6 MAIN (2) WHEEL ASSY, CLEVELAND 40-75B (EACH) BRAKE ASSY, CLEVELAND 30-52 (LEFT) BRAKE ASSY, CLEVELAND 30-52 (RIGHT) TIRE, 6 PLY RATED BLACKWALL (EACH) TUBE (EACH)	1241118-1 & -2 C163001-0301 C163030-0303 C163030-0304 C262003-0204 C262023-0102	39.4* 6.2 3.1 3.1 8.7 44.6*	61.4* 62.1 57.8 62.1 62.1 61.4*
B01-R-2	WHEEL, BRAKE & TIRE ASSY 6.00-6 MAIN (2) WHEEL ASSY, MCCAULEY (EACH) BRAKE ASSY, MCCAULEY (LEFT) BRAKE ASSY, MCCAULEY (RIGHT)	1241118-1 & -2 C163003-0205 C163032-0206	8.4 3.5 3.5	62.1 57.8 57.8

SECTION 6
WEIGHT & BALANCE/
EQUIPMENT LIST

CESSNA
MODEL U206G

ITEM NO	EQUIPMENT LIST DESCRIPTION	REF DRAWING	WT LBS	ARM INS
	C. ELECTRICAL SYSTEMS			
C01-R	BATTERY, 24 VOLT, STANDARD DUTY	C614001-0105	22.8	3.0
C01-O	BATTERY, 24 VOLT, HEAVY DUTY	C614001-0106	24.8	3.0
C04-R	ALTERNATOR CONTROL UNIT, 28 VOLT, WITH LOW AND HIGH VOLTAGE SENSING UNIT	C611005-0101	0.4	3.4
C07-A	GROUND SERVICE PLUG RECEPTACLE	1270552-4	2.2*	-4.5
C10-A	ELEVATOR TRIM, ELECTRIC	1260527-5	4.8*	197.1*
		1260153-3	3.3	215.0
C19-O	ACTUATOR ASSY, STALL SENSOR & PITOT HEATING SYSTEM (NET CHANGE)	1290916-3	0.2	-22.1
C22-A	LIGHTS, INSTL., INSTRUMENT POST (SET OF 23)	1201143-5	0.6	18.5
C23-A	LIGHT ELECTRO LUMINESCENT PANEL	1213789-1	2.3	17.0
C25-A	LIGHT INSTL., CONTROL WHEEL MAP (E89-0) (CHANGES 1260243-2 TO 1260243-10)	1260243-10	0.1	22.5
C31-A	LIGHT INSTL., UNDERWING LIGHT (SET OF 2)	1201054-2	0.5	61.9
C40-A	DETECTORS, NAVIGATION LIGHT (SET OF 2)	0701013-1	NEGL	
C43-R	LIGHT INSTL., NAVIGATION LIGHT (SET OF 2) BEACON LIGHT (IN FIN TIP)	1270836	2.1*	220.8*
		C621001-0102	0.6	256.6
C46-A	LIGHT INSTALLATION, WING TIP STROBE FLASHER LIGHTS IN WING TIPS (SET OF 2)	C594502-0102	0.7	259.4
		1201120	3.1*	43.4*
		C622008-0102	2.3	44.7
		C622006-0101	0.3	40.5
C49-S	WIRING & MISC HARDWARE		0.5	39.2
C61-A	LIGHT, COYL MOUNTED LANDING & TAXI LIGHT, INSTL., ICE DETECTOR	1201100-5	2.0	-28.5
			0.6	-9.6
	D. INSTRUMENTS			
D01-R	INDICATOR, AIRSPEED	C661064-0214	0.7	17.0
D01-O	INDICATOR, TRUE AIRSPEED	1201108-10	0.8	17.0
D04-A	STATIC AIR ALTERNATE SOURCE	1201121-1	0.3	15.4
D07-R	ALTIMETER, SENSITIVE (20,000 FEET)	C661071-0101	1.0	16.5
D07-O-1	ALTIMETER, SENSITIVE (FEET & MILLIBARS)	C661071-0102	0.8	16.5
D07-O-2	ALTIMETER, SENSITIVE (20,000 FEET)	C661071	0.9	16.5
D07-O-3	ALTIMETER, SENSITIVE (35,000 FEET)	C661025-0102	1.0	16.5

ITEM NO	EQUIPMENT LIST DESCRIPTION	REF DRAWING	WT LBS	ARM INS
D10-A	(35,000 FEET) ALTIMETER, SENSITIVE (2ND INSTL. - MAKES DUAL ALTIMETER INSTL.)	1213681-2	0.8	17.8
D16-A-1	ALTITUDE ENCODER (USED WITH ALTITUDE RECORDING TRANSDUCER) (REQUIRES ITEM D10-A SENSITIVE ALTIMETER)	1213732-7,-8	2.8	15.1
D16-A-2	ALTITUDE ENCODER--BLIND (DOES NOT REQUIRE PANEL MOUNTING)	1201078-5, -6	1.6*	15.5*
D25-S	MISC HARDWARE	C744001-0101	1.3	15.8
D25-O	CLOCK, ELECTRIC	C664508-0102	0.3	14.2
D28-R	COMPASS, MAGNETIC	C664511-0101	0.2	17.5
D34-R	INSTRUMENT CLUSTER, ENGINE	1213679-1	0.8	17.5
D49-A	INDICATOR INSTALLATION, ECONOMY MIXTURE EGT INDICATOR, ALCCOR 202-74Y THERMOCOUPLE LEAD WIRE	C669545-0107 1200677-3 C668501-0211	1.5*	21.3
D55-R	GAUGE, MANIFOLD PRESSURE & FUEL FLOW	C668501-0204	0.6*	18.0*
D64-A-1	GYRO, INSTALLATION A61-A VACUUM SYSTEM (REQUIRES ITEM A61-A VACUUM SYSTEM)	C662037-0103 1201069-2	0.1 1.0	17.3 16.5
D64-A-2	GYRO, INSTALLATION A61-A VACUUM SYSTEM (REQUIRES ITEM A61-A VACUUM SYSTEM)	C661075-0106 C661076-0105 C294501-0101	1.9 2.2 0.5	15.1 15.1 11.5
D64-A-3	GYRO, INSTALLATION FOR 400 NAV-O-MATIC (REQUIRES ITEM A61-A VACUUM SYSTEM)	1201069	7.0*	10.7 13.8*
D64-A-4	GYRO, INSTALLATION FOR 400 NAV-O-MATIC (REQUIRES ITEM A61-A VACUUM SYSTEM)	40760 1201075	2.6 0.5	14.0 11.5
D64-A-5	CONNECTING HOSES & MISC. ITEMS GYRO INSTALLATION FOR 400 NAV-O-MATIC (REQUIRES ITEM A61-A VACUUM SYSTEM)	1201069	7.0*	10.8*
D64-A-6	CONNECTING HOSES & MISC. ITEMS GYRO INSTALLATION FOR NON-SLAVED HSI (USED WITH ITEM H09-A)	40760 37570 1201075	2.6 0.5 0.5	14.7 15.5 11.0*
D67-A	HORIZONTAL INDICATOR HOSES, CLAMPS & MISC HARDWARE HOURMETER INSTALLATION	1201069 C661076 1200747-5	3.6* 2.2 1.4 0.4	13.5* 15.3 11.6 9.0

SECTION 6
WEIGHT & BALANCE/
EQUIPMENT LIST

CESSNA
MODEL U206G

ITEM NO	EQUIPMENT LIST DESCRIPTION	REF DRAWING	WT LBS	ARM INS
D82-S	GAUGE, OUTSIDE AIR TEMP. (C668507-0101)	0701010	0.1	26.5
D85-R	TACHOMETER, RECORDING	C668020-0107	0.6	16.8
D88-S-1	INDICATOR, TURN COORDINATOR, 28 VOLT	C661003-0505	1.3	16.8
D88-S-2	INDICATOR, TURN COORDINATOR, 10-28 VOLT	C661003-0506	1.6	16.8
D88-O-1	INDICATOR, TURN COORDINATOR (FOR USE WITH 200A & 300A NAV-O-MATIC)	42320-0028	1.3	16.8
D88-O-2	INDICATOR, TURN & BANK	S1303-2	1.0	16.5
D91-S	INDICATOR, VERTICAL SPEED	C661080-0101	1.0	16.5
E. CABIN ACCOMMODATIONS				
F01-A	ARM REST, FRONT SEAT INBOARD (SET OF 2)	1214121	1.5	37.0
F02-A	ARM REST, 2ND ROW SEAT INBOARD (SET OF 2)	1214121	1.5	74.0
F05-R	SEAT, PILOT	1214154	13.7	44.5
F05-C-1	SEAT PILOT - INFINITE ADJUST		13.0	40.8
F05-C-2	SEAT PILOT - UTILILINE		14.0	44.5
F05-C-3	SEAT PILOT - UTILILINE, INFINITE ADJUST		13.7	40.8
F07-S	SEAT, CO-PILOT	0714025	14.2	44.5
F07-O-1	SEAT, CO-PILOT - INFINITE ADJUST	1214154	13.0	40.8
F07-O-2	SEAT, CO-PILOT - UTILILINE		13.0	40.8
F07-O-3	SEAT, CO-PILOT - UTILILINE, INFINITE ADJ.		14.2	44.5
F09-S	SEATS, SECOND ROW - UTILILINE (SET OF 2)	0714025	25.8	78.0
F09-O-1	SEATS, SECOND ROW - UTILILINE (SET OF 2)	1214126	16.2	72.0
F09-O-2	SEATS, SECOND ROW - REAR FACING (SET OF 2)	1214127	16.0	63.0
F11-S	SEATS, THIRD ROW (SET OF 2)	1214127	21.7	104.3
F11-O	SEATS, THIRD ROW - UTILILINE (SET OF 2)	1214151-1	13.0	37.0
F15-R	SAFETY BELT HARNESS, PILOT	S-2275-103	1.1	37.0
F15-S	SAFETY BELT HARNESS, PILOT	S-2275-201	1.6	37.0
F15-C	SAFETY BELT HARNESS, PILOT HARNESS, INERTIA (NET CHANGE)	1201156	2.1	102.4
F19-C	REFL INSTL. & SHOULDER HARNESS, INERTIA (USED WITH UTILITY OPTION SEAT)	1201136	3.8	89.1
F23-S	SAFETY BELTS, SHOULDER HARNESS, INERTIA (NET CHANGE)	S-2275-3	1.6	37.0
F27-S	SAFETY BELTS, PILOT & CO-PILOT (NET CHG)	S-1746	2.0	74.0
F27-C	SAFETY BELTS, SHOULDER HARNESS, CO-PILOT (SET OF 2)	S-2275	1.2	74.0
F29-S	SAFETY BELTS, SECOND ROW HARNESS, (NET CHANGE)	S-1746	2.0	95.5
F29-C	SAFETY BELTS, THIRD ROW HARNESS, (NET CHANGE)	S-2275	1.2	95.5

ITEM NO	EQUIPMENT LIST DESCRIPTION	REF DRAWING	WT LBS	ARM INS
F34-A	UTILITY UPHOLSTERY (NET DECREASE) (FOR USE WITH J07-A-1, J07-A-2, J07-A-3, OR J07-A-4)	1215986	-6.4	69.2
F35-A-1	LEATHER SEATING INSTALLATION (NET CHANGE) (ADDS WEIGHT OF 0.5 LB. PER SEAT) (LEATHER WEARABLE COVERING)	CES-1158	3.0	73.3
F35-A-2	LEATHER WEARABLE RH	1211891-5	1.5	73.3
F37-0	WINDOW, OPENABLE AND AFT CARGO DOORS, FORWARD AND AFT CARGO DOORS, INSTALLED ARM CARGO DOORS)	1211670&1211673	2.3	48.0
F41-S	SPOTLER KIT, (INCL. UDES E41-A-1 INSTL)	1200197-2	22.4	67.3
F41-A-1	SKYOLIVING REAR WINDOW	1201008-8	2.1	69.7
F45-A	CURTAIN SYSTEM, 48 CU. FT. CAPACITY	1200714-1	1.5	106.5
F47-A	OXYGEN SYSTEM, C166002-0401 REGULATOR (EMPTY CYLINDER & C166002-0401 REGULATOR OXYGEN MASKS (1) PILOT, (2) PASSENGERS) (48 CU. FT. @ 1800 PSI), (OXYGEN @ 0.9832 LBS./CU. FT., RETRACTABLE CUP HOLDER, RETRACTABLE HEADRESTS, FRONT SEAT (SET OF 2) HEADRESTS, REAR SEAT (SET OF 2) SUN VISORS (SET OF 2) HOLDER, APPROACH PLATE NET, BAGGAGE RETAINING STRUTTER (BOXED) (USE ACTUAL INSTALLED WT & ARM)	1201124-1, -4 1201124-1 1215073-1 1215073-1 1215073-1 0514151-1 1215036-2 1201123-1 0700164-5	0.1 0.1 1.4 1.4 1.4 1.0 0.2 0.2 2.5	15.0 15.0 47.0 74.0 95.5 33.0 27.0 171.5
F49-A-1	MORTUARY KIT (WITH OXYGEN BCTILE)	1210059-1	84.9	91.2
F49-A-2	AMRULANCE DUAL (WHEEL, PEDALS, TOE BRAKES)	1210080-21	68.0	76.0
F51-A	CONTROL PEDALS (DISENGAGEABLE, AVAILABLE WITH RH CONTROL)	1260004-10	6.7	14.1
F52-A	RUDDER PEDALS (DISENGAGEABLE, AVAILABLE WITH RH CONTROL)	1260455-3	1.3	5.9
F59-A	CONTROL WHEEL - ALL PURPOSE (NET CHANGE)	1260243-10	0.0	-12.5*
F65-S	CABIN HEATING (INCLUDED ENG. EXHAUST SYST) EXHAUST & HEATER, LEFT SIDE	1250264	14.9*	-12.9*
F75-A	EXHAUST & HEATER, RIGHT SIDE	1250263	7.7	-10.2
F77-A	F. PLACARDS, WARNINGS & MANUALS			

SECTION 6
WEIGHT & BALANCE/
EQUIPMENT LIST

CESSNA
MODEL U206G

ITEM NO	EQUIPMENT LIST DESCRIPTION	REF DRAWING	WT LBS	ARM INS
F01-R	PLACARD - OPERATIONAL, VFR (DAY-NIGHT) (STD. STATIONAIR)	0505087-8	NEGL	-
F01-0-1	PLACARD - OPERATIONAL, IFR (DAY-NIGHT) (STD. STATIONAIR)	0505087-9	NEGL	-
F01-0-2	PLACARD - OPERATIONAL, VFR (DAY-NIGHT) (UTILITY STATIONAIR)	0505087-14	NEGL	-
F01-0-3	PLACARD - OPERATIONAL, IFR (DAY-NIGHT) (UTILITY STATIONAIR)	0505087-15	NEGL	-
F04-R	INDICATOR, STALL WARNING, AUDIBLE	1220090	0.3	14.0
F10-S	PILOT CHECKLIST (STOWED)	06035	0.3	-
F16-R	PILOTS OPERATING HANDBOOK AND FAA APPROVED FLIGHT MANUAL (STOWED)	D1182-13PH	1.5	-
G. AUXILIARY EQUIPMENT				
G04-A	HOOK, TOW (INSTALLED ARM SHOWN, NOT FACTORY INSTALLED)	0712643-1	0.5	231.0
G07-A	RINGS, AIRPLANE HOISTING	1201142-2	0.8	74.4
G13-A	CORROSION PROOFING, INTERNAL	1260100-7	18.0	81.7
G16-A	DISCHARGERS, STATIC (SET CF 10)	1201140-1	0.4	153.6
G19-A	STABILIZER, AIRPLANE (STOWED)	0500041-2	1.5	206.0
G22-S	TOW BAR, AIRPLANE (TELESCOPING HANDLE)	0501019	1.6	127.0
G22-C	PAINT, OVERALL EXTERIOR (MODIFIED POLY- URETHANE)	0700315-4	2.0	127.0
G25-S	OVERALL, BASE WHITE COVERED STRIPE	1204038	14.2*	191.5*
G31-C	WASH PRIME COATING		12.5	94.3
G51-A-1	CABLES CORROSION RESISTANT (NET CHANGE)	1260417-7	1.2	61.2
G55-A-2	FIRE EXTINGUISHER, STD PILOT SEAT	0701014-1	0.5	94.3
G61-A	FIRE EXTINGUISHER, VTL ADJ SEAT	0701014-2	0.0	35.0
G67-A	WRITING TABLE		3.0	29.0
G79-A	RUDDER PEDAL EXTENSIONS, REMOVABLE - SET OF 2 (STOWABLE, INSTALLED ARM SHOWN)	0701048-1	3.6	60.0
G82-A	PROPELLER ANTI-ICING SYSTEM INSTALLATION WIND-REMOVABLE HEATER PANEL (INSTALLED ARM SHOWN)	1201072-2	6.6	-18.4
G84-A	PHOTOGRAPHIC PROVISIONS (NOT COMPATIBLE WITH CLUB SEATING)	1513460	2.1*	9.0
		1201107-35,-36	1.9	
			9.5	77.0

ITEM NO	EQUIPMENT LIST DESCRIPTION	REF DRAWING	WT LBS	ARM INS
C88-A 694-A	WINTERFRONT CARGO PACK. EXTERNAL BELLY MOUNTED	1200702-12 1200641-35	0.4 32.0	-42.3 51.0
H01-A-1	H. AVIONICS & AUTOPILOTS CESSNA 300 ADF W/BFO, NO CARGO POD RECEIVER WITH INDICATOR (R-546E) GONIOMETER ANTENNA (IN-346A) ADF LOOP ANTENNA ADF SENSE ANTENNA WIRING & MISC HARDWARE	3910159-6 41240-0001 40980-1001 41000-1000 3960115-2	8.0* 3.3 3.9 1.4 0.3	24.1* 14.5 16.5 139.8 119.3
H01-A-2	CESSNA 300 ADF W/BFO & CARGO POD INSTALLED (SAME AS H01-A-1 ABOVE EXCEPT THE LOOP ANTENNA IS MOVED FROM STA. 39.8 TO STA. 144.5 AND NEW LOOP CABLE USED)	3910159-6	2.0 9.0*	49.5*
H01-A-3	CESSNA 400 ADF W/BFO, NO CARGO POD RECEIVER, 24 VOLT (R-446A) GONIOMETER ANTENNA ADF LOOP ANTENNA ADF SENSE ANTENNA	3910160-6 43090-1028 40980-1001 41000-1000	8.0* 3.3 0.9 1.4 0.3	24.1* 14.5 16.5 139.8 119.3
H01-A-4	CESSNA 400 ADF W/BFO & CARGO POD INSTALLED (SAME AS H01-A-3 ABOVE EXCEPT THE LOOP ANTENNA IS MOVED FROM STA. 39.8 TO STA. 144.5 AND NEW LOOP CABLE USED)	3910160-6	2.0 9.0*	49.5*
H03-A	AM/FM STEREO & CASSETTE RECEIVER/PLAYER HEADSETS (MT LISTED PER SET OF 2) STEREO INSTL	3910309 C596532-0101 3930211	5.4* 2.7 2.0	31.5* 37.0 15.0
H04-A-1	NARCO DME 190 ANT. WIRING & MISC ITEMS RECEIVER & TRANSCIVER WIRING & MISC ITEMS	3910166-7 3312-406	7.0* 7.0* 5.0	79.4* 22.8 13.0
H04-A-2	CESSNA 400 DME CONTROL UNIT (RT-476) REMOTE RECEIVER/TRANSMITTER (RTA-476A) ANTENNA	3910167-13 44020-1000 44000-0000 42340-0000 44088-0000	1.4* 1.6 1.9 0.2 0.6	148.8* 142.0 159.3 159.3 115.3
H05-A-1	CESSNA 400 R-NAV SYSTEM W/IN442-AR EXCHG COMPUTER (RN-478A)	3910168 44100-0000	3.4* 3.8	155.3* 114.0

SECTION 6
WEIGHT & BALANCE/
EQUIPMENT LIST

CESSNA
MODEL U206G

ITEM NO	EQUIPMENT LIST DESCRIPTION	REF DRAWING	WT LBS	ARM INS
H05-A-2	INDICATOR, IN-442AR ADDED INDICATOR, IN-385A DELETED WIRING & HARDWARE FOSTER R-NAV W/NAV OR CESSA DME FOSTER 511 R-NAV RECEIVER DME ADAPTER INSTL. WIRING & HARDWARE	43910-1000 46860-1000 3910203 805A0202-1 3940258	1.0 -1.6 3.0* 2.4 0.3 4.3*	16.5 16.9 18.4* 15.0 58.0 -6.4
H07-A	CESSNA 400 GLIDESLIP W/VOR-ILS INDICATOR EXCHANGED W/VOR-LOC INDICATOR RECEIVER (R-4238) ANTENNA (LOCATED) ON UPPER WINDSHIELD) VOR/ILS INDICATOR (IN-386A) ADDED VOR/LOC INDICATOR (IN-385A) DELETED WIRING & MISC ITEMS	3910157-12 42100-0000 1200098-1 46860-2000 46860-1000	2.1 0.7 0.7 -1.6 0.2*	-16.0 -29.6 15.5 15.2 13.3*
H08-A-1	NAV. INDICATOR W/VOR-LOC EXCHG W/VOR-LOC ARC/LOC IN-385AC AUTO RADIAL CENTERING ADDED VOR/LOC IN-385A (H22-A-1 & H25-A-1) DELETED	3910196-1 46860-2000 3910195-2	-1.6 0.1* 1.9	15.5 15.5* 15.5
H08-A-2	NAV. INDICATOR W/ARC-ILS EXCHG W/VOR-ILS ARC/ILS IN-386AC AUTO RADIAL CENTERING ADDED	46860-2000 3910195-2	-1.8 -4.9*	15.5* 4.5*
H09-A	CESSNA HSI, NON SLAVED, INDICATOR DELETED VOR INDICATOR HST INDICATOR ADDED MOUNTING CONVERTER HST VOR INDICATOR 300 GR 400 SERIES DELETED WIRING & MISC ITEMS	44690-2000 43270-0000 47240-0000 46860-1000	4.5 0.9 0.9 -1.6 0.9*	14.5 14.5 -15.0 -15.8 11.4-2*
H11-A-1	PANTRONICS HF TRANSMITTER RFMCTF POWER SUPPLY (PT10-A) RFMCTF POWER SUPPLY (PT10-PS-28) ANTENNA LOAD BOX (DX10-RL-28) ANTENNA INSTL. 351 INCHES LONG WIRING & MISC ITEMS	3910193-12 C385103-0101 C585103-0301 C589502-0201 3960117-1 3950127-40 3950158-13	24.2 8.5 4.3 0.3 3.0 24.1*	11.7 159.2 147.0 157.2* 111.7 159.3
H11-A-2	SUNTRANCE RECEIVER SSB ASB-125 (RE-1010A) RECEIVE POWER AMPLIFIER (PA-1010A) ANTENNA COUPLER (LOAD BOX) (CU-110) ANTENNA INSTL. 351 INCHES LONG WIRING, CABLE & MISC HARDWARE	99681 99682 99683 3960117-1 3950127-39	8.5 5.9 4.3 4.0 9.2	150.0 150.0 150.0 150.0 158.0

ITEM NO	EQUIPMENT LIST DESCRIPTION	REF DRAWING	WT LBS	ARM INS
H13-A	CESSNA 400 MARKER BEACON RECEIVER (R-402A)	3910164-7	2.8*	99.1*
	ANTENNA INSTL (FLUSH MTD IN TAILCONE)	42410-5128	0.7	11.5
	WIRING & MISC HARDWARE	3960126-2	0.9	190.6
H16-A-1	CESSNA 300 TRANSPONDER RECEIVER (RT-385A)	3910127-24	1.2*	181.9*
	ANTENNA & MISC HARDWARE	41420-0028	3.6*	211.5
	WIRING & MISC HARDWARE	42940-0000	2.7	133.2
H16-A-2	CESSNA 400 TRANSPONDER RECEIVER (RT-459A)	3910128-18	0.1	39.2*
	ANTENNA & MISC HARDWARE	41470-1028	0.8*	21.5*
	WIRING & MISC HARDWARE	42940-0000	2.8	11.5
H22-A-1	CESSNA 300 NAV/COM 720 CH COM, 1ST UNIT (REQUIRES H34-A TO BE OPERATIONAL)	3910183-24	0.1	133.0*
	RECEIVER-TRANSCIVER (RT-385A)	46660-1000	8.1*	13.0*
	VOR/LOC INDICATOR (IN-385A)	46860-1000	5.5	12.5
	MOUNT, WIRING & MISC HARDWARE	46860-1000	1.6	15.5
H22-A-2	CESSNA 400 NAV/COM WITH IN-385A (300 SERIES) INDICATOR (1ST UNIT)	3910189-7*-8	1.0	11.8
	(REQUIRES H34-A TO BE OPERATIONAL)		8.1*	13.0*
	RECEIVER - TRANSCIVER (RT-485A)	47360-1000	5.5	12.5
	VOR/LOC INDICATOR (IN-385A)	46860-1000	1.6	15.5
	WIRING & MISC HARDWARE	3910183	8.1*	13.0*
H25-A-1	CESSNA 300 NAV/COM 720 CH COM (2ND UNIT) (REQUIRES H37-A TO BE OPERATIONAL)	3910183	5.5	12.5
	RECEIVER - TRANSCIVER (RT-385A)	46660-1000	1.6	15.5
	VOR/LOC INDICATOR (IN-385A)	46860-1000	1.0	11.8
	MOUNT, WIRING & MISC HARDWARE	3910189	8.1*	13.0*
H25-A-2	CESSNA 400 NAV/COM 720 CH COM (300 SERIES) INDICATOR, 2ND UNIT	3910189	5.5	12.5
	(REQUIRES H37-A TO BE OPERATIONAL)	47360-1000	1.6	15.5
	RECEIVER - TRANSCIVER (RT-485A)	46860-1000	1.0	11.8
	VOR/LOC INDICATOR (IN-385A)	46860-1000	5.5	12.5
	MOUNT, WIRING & MISC HARDWARE	46860-1000	1.6	15.5
	INDICATOR, 2ND UNIT	3910189	8.1*	13.0*
	(REQUIRES H37-A TO BE OPERATIONAL)		5.5	12.5
	RECEIVER - TRANSCIVER (RT-485A)	47360-1000	1.6	15.5
	VOR/LOC INDICATOR (IN-385A)	46860-1000	1.0	11.8
H28-A-1	EMERGENCY LOCATOR TRANSMITTER ANTENNA	0470419-11	3.5*	11.6*
	WIRING & MISC HARDWARE	C589511-0117	3.3	157.6*
	TRANSMITTER (D & M DMELT-6-1)	C589511-0109	0.1	158.0
	ANTENNA	0470419-12	0.1	153.7
	CABLE & HDWR		3.5*	157.6*
H28-A-2	EMERGENCY LOCATOR TRANSMITTER (FOR USE IN CANADA)	C589511-0113	3.3	158.0
	TRANSMITTER (D & M DMELT-6-1C)	C589511-0109	0.1	154.4
	ANTENNA		3.5*	153.7

SECTION 6
WEIGHT & BALANCE/
EQUIPMENT LIST

CESSNA
MODEL U206G

ITEM NO	EQUIPMENT LIST DESCRIPTION	REF DRAWING	WT LBS	ARM INS
H31-A-1	CARLE & HDWR. AUTOPILOT NAV-O-MATIC 200A AUTOPILOT COMPUTER-CONTROLLER TURN COORDINATOR D88-O-1 (NET CHANGE) WING SERVO RELAY INSTALLATION (SET OF 2) MISC ITEM & WIRING NAV-O-MATIC 300A AUTOPILOT	3910162-12 43610-1202 42320-0028 42730-4908 3970135-3	0.1* 7.9* 1.0 3.8 0.5 18.9*	153.7 41.6* 15.5 53.1 3.0 43.4*
H31-A-2	CONTROLLER INSTL TURN COORDINATOR (NET CHANGE) WING SERVO RELAY INSTALLATION (SET OF 2) GYRO INSTL VACUUM SYSTEM INSTL. MISC ITEMS & WIRING NAV-O-MATIC 300A AUTOPILOT FOR USE ON STATIONAIR II	42660-1202 42320-0028 42730-4908 3970135-3 1201089 1201055-1 3910163-12	1.0 3.8 7.0 3.3 2.5 9.3*	15.5 1.1 53.1 23.4* 15.5 1.1 53.1 13.0
H31-A-3	SAMP AS H31-A-2 EXCEPT AS FOLLOWS A61-A VACUUM SYSTEM NOT INCLUDED (STANDARD ON STATIONAIR III) D64-A-1 GYRO INSTL DELETED FOR D64-A-1 (ITEM D64-A-2 EXCHANGED FOR D64-A-1 WHICH IS STANDARD ON STATIONAIR II) NAV-O-MATIC 400 AUTOPILOT CONTROLLER COMPUTER-AMPLIFIER ALEXON ROLL ACTUATOR ELEVATOR PITCH ACTUATOR GYRO INSTL	1201055-1 1201069-2	18.9 -3.3 -6.3	23.4 -2.7 13.8
H31-A-4	VACUUM SYSTEM INSTL PARTS MISC. WIRING & PARTS NAV-O-MATIC 400 AUTOPILOT FOR USE ON STATIONAIR II SAMP AS H31-A-4 EXCEPT AS FOLLOWS A61-A VACUUM SYSTEM NOT INCLUDED (STANDARD ON STATIONAIR II) D64-A-1 GYRO INSTL DELETED (ITEM D64-A-3 EXCHANGED FOR D64-A-1 WHICH IS STANDARD ON STATIONAIR II) BASIC AVIONICS KIT (REQUIRED WITH 1ST UNIT NAV/COM RADIO) CONSISTS OF--	1270651-30,-32 41540-1028 35910-1528 35070-1128 1201069-2 1201055-1 1270651-30,-32	31.8* 1.3 5.8 3.4 3.0 2.3 5.3 22.2*	74.9* 17.4 155.6 153.7 113.2 112.7 50.6 100.3 103.8*
H31-A-5	NAV-O-MATIC 400 AUTOPILOT FOR USE ON STATIONAIR II SAMP AS H31-A-4 EXCEPT AS FOLLOWS A61-A VACUUM SYSTEM NOT INCLUDED (STANDARD ON STATIONAIR II) D64-A-1 GYRO INSTL DELETED (ITEM D64-A-3 EXCHANGED FOR D64-A-1 WHICH IS STANDARD ON STATIONAIR II) BASIC AVIONICS KIT (REQUIRED WITH 1ST UNIT NAV/COM RADIO) CONSISTS OF--	1201055-1 1201069-2	31.8 -3.3 -6.3	74.9 -2.7 13.8
H34-A	BASIC AVIONICS KIT (REQUIRED WITH 1ST UNIT NAV/COM RADIO) CONSISTS OF--	3910186-9	8.3*	58.8*

ITEM NO	EQUIPMENT LIST DESCRIPTION	REF DRAWING	WT LBS	ARM INS
	CARIN SPEAKER INSTALLATION	1270675-734	2.0	45.0
	RADIO COOLING	3930208-4	1.1	12.4
	NOISE FILTER, AUDIO (ON ALTERNATOR)	3940148-1	0.0	-2.0
	VHF COM ANTENNA CABLE	3950127-47	0.5	27.8
	VHF OMNI ANTENNA	3950127-10	1.0	125.2
	VHF COM ANTENNA (SPIKE ON CABIN TOP)	3960102-6	0.6	250.6
	MICROPHONE, HAND HELD	3960113-2	0.3	63.4
	HEADPHONE, SET INSTALLATION	3970109-1	0.2	17.5
	RUS BAR, INSTL	3970118-7	NEGL	19.1
	1ST N/C TRANSCEIVER KIT	3930186-6	0.1	18.0
	RADIO-AUDIO SWITCH PANEL & WIRING	3930186-6	0.1	18.0
	COM ANTENNA INSTL & OMNI COUPLER KIT (REQUIRED WITH 2ND UNIT INSTALLATION)	3970147-1	1.8*	32.5*
H37-A	OMNI ANTENNA COUPLER ASSY (LEFT HAND)	3970185-7	0.4	27.8
H46-A	2ND N/C TRANSCEIVER KIT	3950127-48	0.2	5.0
H52-A	VHF COM ANTENNA (LEFT HAND)	3960111-8	0.5	63.4
H55-A	VHF ANTENNA COUPLER KIT	3960113-7	0.1	18.0
H56-A	2ND N/C TRANSCEIVER KIT	3930186-7	0.8	158.3
	ADP ANTIL-RECIPT ANTENNA	3910154-66	2.4	184.6
	ANTENNA, FLUSH MOUNTED COM (VTL FIN)	3910154-67	0.3	18.0
	MICROPHONE/HEADSET COMBINATION, PADDED (STOWED ITEM)	C596530-0101	1.1	19.1
H64-A	OPTION 'A', PARTIAL (EXPCRT CMLY)	3910206-15	5.1	81.9
H67-A	OPTION 'B', PARTIAL (EXPORT ONLY)	3910206-16	6.4	72.8
H70-A	REMOTE TRANSDUCER IDENT SWITCH OPTION (REQUIRES E89-0)	3910205-3	6.2	17.0
	J. SPECIAL OPTION PACKAGES			
J01-A	STATIONNAIR II EQUIPMENT CONSISTS OF THE FOLLOWING ITEMS	1200300-47	59.0*	33.2*
	A61-A VACUUM SYSTEM	1201055-1	3.3	-2.7
	C07-A GROUND SERVICE RECEPTACLE	1270652-4	2.2	-4.5
	C19-0 HEATING SERVICE WARNING & PILOT (NET CHANGE)	1200816-3	0.2	22.1
	C31-A UNDERWING COURTESY LIGHTS	1201054-2	0.5	61.9
	C40-A NAVIGATION LIGHT DETECTORS (2)	0701013-1	NEGL	-
	D01-0 TRUE AIRSPEED IND. (NET CHANGE)	1201108-10	0.1	17.0
	D04-A STATIC AIR ALTERNATE SOURCE	1201121-1	0.3	15.4

SECTION 6
WEIGHT & BALANCE/
EQUIPMENT LIST

CESSNA
MODEL U206G

ITEM NO	EQUIPMENT LIST DESCRIPTION	REF DRAWING	WT LBS	ARM INS
J04-A	<p>D49-A-1 INDICATOR, ECONOMY MIXTURE</p> <p>G64-A-1 GYRO INSTALLATION</p> <p>F85-A DUAL CONTROLS</p> <p>G25-S EXTERIOR STYLING (NET CHANGE)</p> <p>H01-A-1 300 ADF</p> <p>H16-A-1 300 NAV TRANSPENDER</p> <p>H22-A-1 300 NAV/COM</p> <p>H28-A-1 ELT (EMERGENCY LOCATOR XMTR)</p> <p>H31-A-1 200A NAV-O-MATIC</p> <p>H34-A-1 BASIC NAVIONICS KIT</p> <p>NAV-PAC INSTALLATION COM, 2ND UNIT</p> <p>H25-A-1 300 NAV/COM SCOPE</p> <p>H07-A 400 GLIDESLOPE</p> <p>H13-A 400 MARKER BEACON</p> <p>H17-A COM ANT & CMNI COUPLER KIT</p> <p>UTILITY OPTION WITH SIX SEATS (NET CHANGE)</p> <p>STANDARD SIX SEATS DELETED</p> <p>WHEEL FAIRING (810-S) DELETED</p> <p>UTILITY SIX SEATS OPTION ADDED</p> <p>FLOAT INSTALL. EDO MODEL 582-3430 (SET OF 2)</p> <p>(THIS IS AN ADDITION TO ITEM J30-A-1 WITHOUT CORROSION PROOFING PAINT AND CORROSION RESISTANT CABLES) (FOR REF. USE ONLY--WEIGHT AND ARM ARE APPROXIMATELY 338 LBS AT 54.4 IN ARM NET CHANGE) (FOR UTILITY. WT & ARM ARE 358 LBS AT 55.4 IN ARM)</p> <p>(USE ACTUAL INSTALLED WT & ARM CHANGE)</p> <p>FLOAT PLANE KIT (HAS WHEEL FAIRING DELETED)</p> <p>STATIONAIR KIT</p> <p>UTILITY LINE OPTION</p> <p>FLOAT PLANE KIT OPTION 'A' ITEMS INSTALLED DURING MANUFACTURE OF AIRCRAFT CONSISTS OF THE FOLLOWING</p> <p>G07-A AIRPLANE HOISTING RINGS</p> <p>G13-A CORROSION PROOFING, INTERNAL</p> <p>G31-0 CORROSION RESISTANT CABLES (NET CHANGE)</p> <p>STEPS & HANDLES, REFUELING ASSIST</p> <p>RUDDER & FLASHING BEACON (NET CHANGE)</p>	<p>1200677-3</p> <p>1201069-2</p> <p>1260004-10</p> <p>1204038</p> <p>3910159-6</p> <p>3910127-24</p> <p>3910183-24</p> <p>0470419</p> <p>3910162-12</p> <p>3910186-9</p> <p>16.5*</p> <p>3910183</p> <p>3910157-12</p> <p>3910164-7</p> <p>3910185-7</p> <p>1200300</p> <p>1201155</p>	<p>0.6</p> <p>6.3</p> <p>6.7</p> <p>NEGL</p> <p>8.0</p> <p>3.6</p> <p>3.5</p> <p>3.9</p> <p>7.9</p> <p>8.3</p> <p>16.5*</p> <p>8.1</p> <p>4.3</p> <p>2.8</p> <p>1.3</p> <p>-45.5*</p> <p>-19.4</p> <p>55.2</p>	<p>8.0</p> <p>13.8</p> <p>14.1</p> <p>1.1</p> <p>24.9</p> <p>21.0</p> <p>13.0</p> <p>157.6</p> <p>41.6</p> <p>54.7*</p> <p>24.7*</p> <p>13.0</p> <p>8.4</p> <p>99.1</p> <p>40.5</p> <p>69.1*</p> <p>73.2</p> <p>44.7</p> <p>66.7</p>
J07-A				
J27-A				
J30-A-1		1201155	16.9*	181.2*
			36.3*	106.3*
			0.8	74.4
			18.0	81.7
			0.0	-
			2.1	13.6
			5.0	263.5

ITEM NO	EQUIPMENT LIST DESCRIPTION	REF DRAWING	WT LBS	ARM INS
	<p>STINGER (NET CHANGE) VERTICAL FIN (NET CHANGE) FORWARD FUSELAGE TAIL DUAL TIE DOWN RINGS COWL DECK V-BRACE FLOATPLANE KIT OPTION 'A', ITEMS INSTALLED AT THE TIME OF FLOAT INSTL. (INCLUDED IN ABOVE TOTAL OPTION 'A' KIT WEIGHTS AND CG'S)</p> <p>EXHAUST PIPE EXTENSIONS WATER RUDDER COVER (EACH) NOSE GEAR ASSY. FLOATPLANE (NET CHANGE)</p> <p>FLOATPLANE KIT OPTION 'B' STATIONAIR (HAS WHEEL FAIRING DELETED) UTIL LINE OPTION 'A' EXCEPT ADD (SAME AS OPTION 'A') STEERING BUNGEE FLOATPLANE (STOWED ITEM)</p> <p>FLOATPLANE KIT OPTION 'C' (FACTORY INSTL. OF HARD TO INSTALL ITEMS) CONSISTS OF-- G13-A CORROSION PROOFING, INTERNAL G11-0 CORROSION RESISTANT CABLES FORWARD FUSELAGE CLUB SEATING ARRANGEMENT DELETE--STANDARD 2ND ROW SEAT (E09-S) ADD --CLUB SEATS, 2ND ROW (SET OF 2) E09-A-2 INCLUDE SEAT BELTS SEAT RAIL CHANGING FOR CLUB SEATS SEAT WRITING TABLE CLUB SEATING WITH MOUNTED ON LH CABIN WALL J43-A-1 WRITING TABLE REFRESHMENT CENTER CLUB SEATING WITH REFRESHMENT CENTER J43-A-1 REGULAR CLUB SEATING REFRESHMENT CENTER-DRY (WEIGHT FOR NOMINAL REFRESHMENT)</p>	<p>1212600 1231985-2 1213751-15 1233000 1242001-20</p> <p>1213624-2 1242013 1233000-1 1242004 1242012 1260644 1201155</p> <p>1260644-15 1201155</p> <p>1260100-4 1260100-4 1213751-15</p>	<p>0.5 -0.4 0.8 0.1 1.5</p> <p>0.6 1.2 4.5 1.3 0.3 0.0</p> <p>20.6* 40.0*</p> <p>3.1</p> <p>0.6 18.8*</p> <p>18.0 NEG 0.8 13.2* -25.8 -22.0 40.0</p> <p>1.0 13.2* 13.2 34.0* 13.2 21.5</p>	<p>270.0 230.0 0.0 229.6 22.5</p> <p>-4.9 2.0 213.9 -4.3 0.0</p> <p>169.7* 109.1* 140.0</p> <p>-4.9 78.2*</p> <p>81.7 0.0 32.7* 78.0 74.0 63.0</p> <p>71.5 44.7* 73.0* 40.3* 32.7 45.0</p>
J30-A-2				
J30-A-3				
J43-A-1				
J43-A-2				
J43-A-3				

SECTION 6
 WEIGHT & BALANCE/
 EQUIPMENT LIST

CESSNA
 MODEL U206G

ITEM NO	EQUIPMENT LIST DESCRIPTION	REF DRAWING	WT. LBS	ARM INS
J43-A-4	CLUB SEATING WITH TABLE AND REFRESHMENT CENTER		39.7	45.0

6.2 AIRCRAFT WEIGHT

Issue	Date	Date of Expiry
7	20 May 2010	Indefinite

Aeroplane Weight and Centre of Gravity Data:

ITEM	WEIGHT (kg)	ARM (mm aft of Datum)	INDEX UNIT (kg mm)	CABIN CONFIGURATION
Empty Weight	975	1013	987354	2+3+2 Seats
Operating Weight	1008	1036	1043879	2+3+2 Seats
Loading & Trim Sheet	1008	---	-6.5	2+3+2 Seats

NOTE:

1. Empty weight includes unusable fuel, full engine oil, first aid kit, fire extinguisher and wood floor boards.
2. Operating Weight includes Empty Weight plus cargo net, straps, tool kit, survival kit, water, power leads and pax scales.
3. Weight and Index Unit shown at Loading and Trim are for use with the current issue of MAF "Cessna TU206G and U206G" Loading and Trim Sheet. Weight is Operating Weight, and Index Unit is based on a modified datum of 1100 mm aft of fuselage station 0.0 and divided by 10,000 so that:

$$I.U. = \frac{Op.Wt. \times (Arm - 1100)}{10,000}$$

Approval Stamp:

MISSION AVIATION FELLOWSHIP	
Airport, Mareeba Qld 4880, Australia	
Certificate of Approval No. C017501	
APPROVED	
Pursuant to CAR <i>CAO 100.7</i>	
<i>[Signature]</i>	
Authorised Person, ARN No. <i>A58870</i>	
Issue <i>7</i>	Date <i>20 MAY 10</i>

SECTION 7

AIRPLANE & SYSTEMS DESCRIPTIONS

TABLE OF CONTENTS

	Page
Introduction	7-3
Airframe	7-3
Flight Controls	7-8
Trim Systems	7-8
Instrument Panel	7-9
Ground Control	7-9
Wing Flap System	7-10
Landing Gear System	7-11
Baggage Compartment	7-11
Seats	7-11
Seat Belts And Shoulder Harnesses	7-12
Seat Belts	7-12
Shoulder Harnesses	7-14
Integrated Seat Belt/Shoulder Harnesses With Inertia Reels	7-14
Entrance Doors And Cabin Windows	7-15
Control Locks	7-17
Engine	7-17
Engine Controls	7-17
Engine Instruments	7-18
New Engine Break-In And Operation	7-19
Engine Oil System	7-19
Ignition-Starter System	7-20
Air Induction System	7-20
Exhaust System	7-21
Fuel Injection System	7-21
Cooling System	7-21
Propeller	7-22
Fuel System	7-22
Brake System	7-26
Electrical System	7-27
Master Switch	7-27
Avionics Power Switch	7-29

TABLE OF CONTENTS (Continued)

	Page
Ammeter	7-21
Alternator Control Unit And Low-Voltage Warning Light	7-29
Circuit Breakers And Fuses	7-30
Ground Service Plug Receptacle	7-30
Lighting Systems	7-31
Exterior Lighting	7-31
Interior Lighting	7-31
Cabin Heating, Ventilating And Defrosting System	7-33
Pitot-Static System And Instruments	7-33
Airspeed Indicator	7-35
Vertical Speed Indicator	7-35
Altimeter	7-36
Vacuum System And Instruments	7-36
Attitude Indicator	7-36
Directional Indicator	7-36
Suction Gage	7-36
Stall Warning System	7-38
Avionics Support Equipment	7-38
Audio Control Panel	7-38
Transmitter Selector Switch	7-38
Audio Selector Switches	7-39
Com Auto Audio Selector Switch	7-41
Com Both Audio Selector Switch	7-41
Auto Audio Selector Switch	7-41
Annunciator Lights Brightness And Test Switch	7-42
Sidetone Operation	7-42
Microphone - Headset Installations	7-43
Static Dischargers	7-43

INTRODUCTION

This section provides description and operation of the airplane and its systems. Some equipment described herein is optional and may not be installed in the airplane. Refer to Section 9, Supplements, for details of other optional systems and equipment.

AIRFRAME

The airplane is an all-metal, six-place, high-wing, single-engine airplane equipped with tricycle landing gear and designed for general utility purposes.

The construction of the fuselage is a conventional formed sheet metal bulkhead, stringer, and skin design referred to as semimonocoque. Major items of structure are the front and rear carry-through spars to which the wings are attached, a bulkhead and forgings for main landing gear attachment under the floorboard aft of the pilot and front passenger seats, and a bulkhead just aft of the instrument panel with attaching plates at its base for the strut-to-fuselage attachment of the wing struts. Structural engine mounts are also incorporated on this airplane.

The externally braced wings, containing integral fuel tanks, are constructed of a front and rear spar with formed sheet metal ribs, doublers, and stringers. The entire structure is covered with aluminum skin. The front spars are equipped with wing-to-fuselage and wing-to-strut attach fittings. The aft spars are equipped with wing-to-fuselage attach fittings, and are partial span spars. Frise-type ailerons and single-slot type flaps are attached to the trailing edge of the wings. The ailerons are constructed of a forward and aft spar, formed sheet metal ribs, "V" type corrugated aluminum skin joined together at the trailing edge, and a formed leading edge containing balance weights. The flaps are constructed basically the same as the ailerons, with the exception of the balance weights and aft spars, and the addition of a trailing edge stiffener.

The empennage (tail assembly) consists of a conventional vertical stabilizer, rudder, horizontal stabilizer, and elevator. The vertical stabilizer consists of a forward and aft spar, formed sheet metal ribs and reinforcements, four skin panels, formed leading edge skins, and a dorsal. The rudder is constructed of a forward and aft spar, formed sheet metal ribs and reinforcements, and a wrap-around skin panel. The top of the rudder incorporates a leading edge extension which contains a balance weight. The horizontal stabilizer is constructed of a forward and aft spar, ribs and stiffeners, center upper skin panel, and two left and two right wrap-around skin panels which also form the leading edges. The horizontal stabilizer

AILERON CONTROL SYSTEM

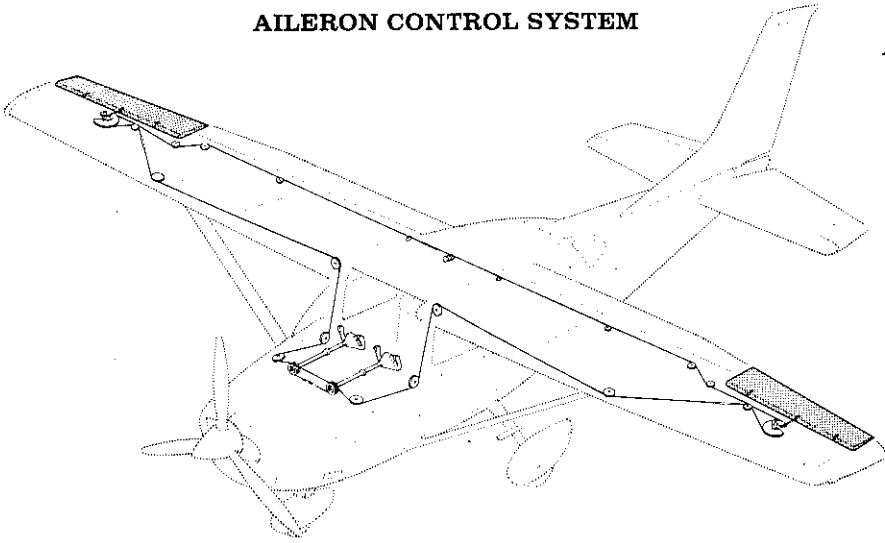

RUDDER AND RUDDER TRIM CONTROL SYSTEMS

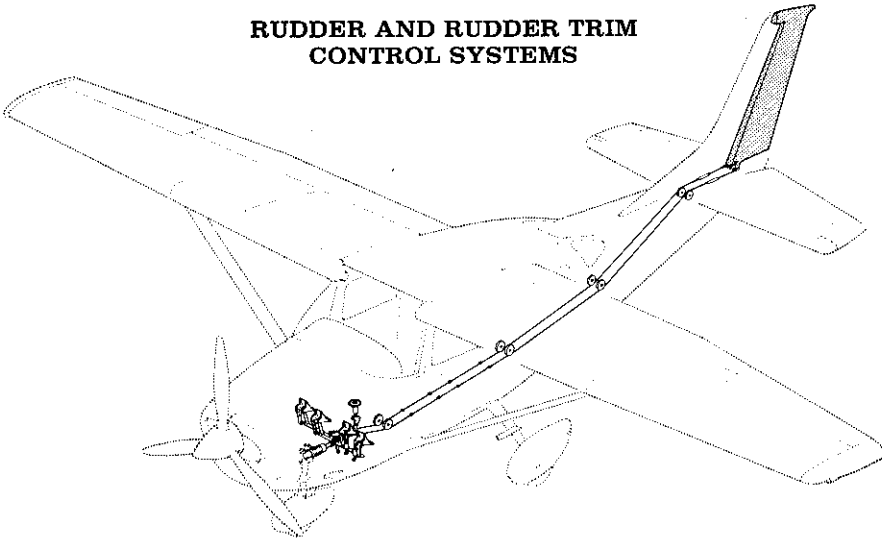
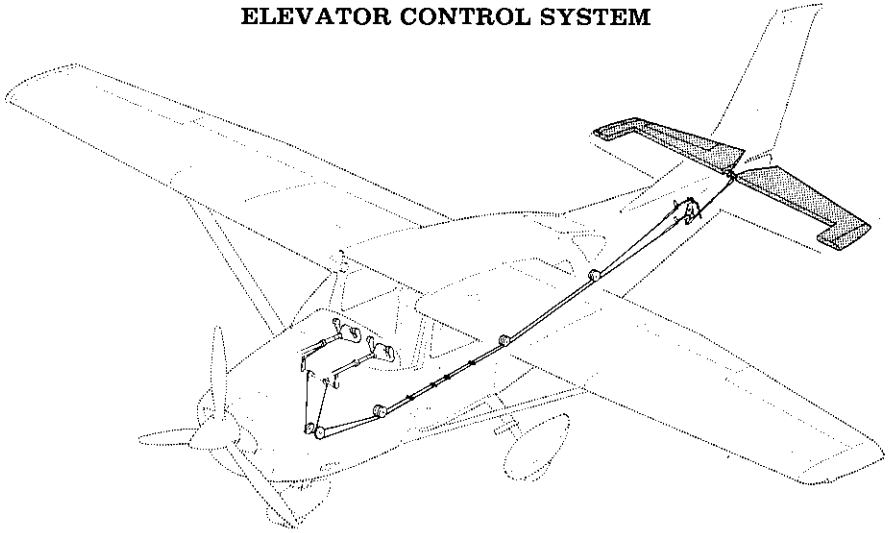

Figure 7-1. Flight Control and Trim Systems (Sheet 1 of 2)

ELEVATOR CONTROL SYSTEM



ELEVATOR TRIM CONTROL SYSTEM

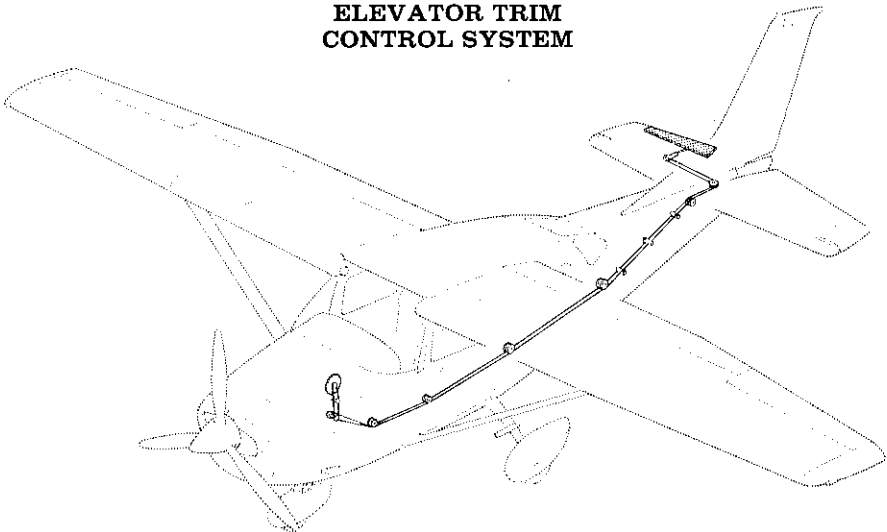

Figure 7-1. Flight Control and Trim Systems (Sheet 2 of 2)

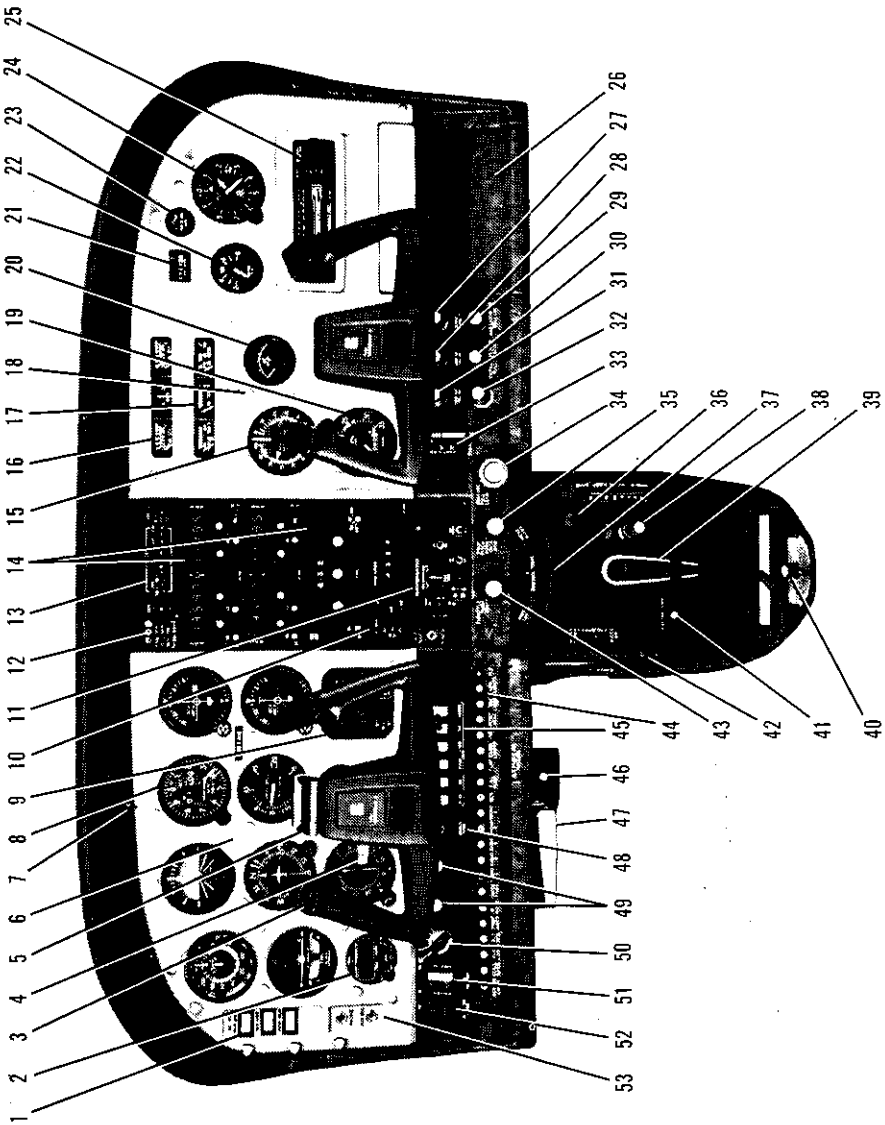

Figure 7-2. Instrument Panel (Sheet 1 of 2)

1.	Anti-Icing Equipment Switch Panel	27.	Defrost Control
2.	Digital Clock	28.	Cabin Air Control
3.	Electric Elevator Trim Switch	29.	Auxiliary Cabin Air Control
4.	Electric Elevator Trim Disengage Switch	30.	Copilot's Stowable Rudder Pedal Control
5.	Approach Plate Holder	31.	Cabin Heat Control
6.	Flight Instrument Group	32.	Cigar Lighter
7.	Map Light and Switch	33.	Wing Flap Switch and Position Indicator
8.	Encoding Altimeter	34.	Mixture Control
9.	DME	35.	Propeller Control
10.	Transponder	36.	Cowl Flap Control Lever
11.	Autopilot Control Unit	37.	Rudder Trim Control Wheel and Position Indicator
12.	Marker Beacon Indicator Lights and Switches	38.	Primer
13.	Audio Control Panel	39.	Microphone
14.	NAV/COM and ADF Radios	40.	Fuel Selector Valve Handle
15.	Manifold Pressure/Fuel Flow Indicator	41.	Electric Elevator Trim Circuit Breaker
16.	Fuel Quantity Indicators and Ammeter	42.	Elevator Trim Control Wheel and Position Indicator
17.	Cylinder Head Temperature, Oil Temperature, and Oil Pressure Gages	43.	Throttle (With Friction Lock)
18.	Low-Voltage Warning Light	44.	Circuit Breakers
19.	Tachometer	45.	Electrical Switches
20.	Economy Mixture Indicator (EGT)	46.	Static Pressure Alternate Source Valve
21.	Flight Hour Recorder	47.	Parking Brake Handle
22.	Suction Gage	48.	Avionics Power Switch
23.	Propeller Anti-Ice Ammeter	49.	Instrument and Radio Dial Lights Rheostats
24.	Secondary Altimeter	50.	Ignition Switch
25.	AM/FM Cassette Stereo Entertainment Center	51.	Auxiliary Fuel Pump Switch
26.	Map Compartment	52.	Master Switch
		53.	Phone and Auxiliary Mike Jacks

Figure 7-2. Instrument Panel (Sheet 2 of 2)

also contains the elevator trim tab actuator. Construction of the elevator consists of a forward and aft spar, ribs, torque tube and bellcrank, left upper and lower skin panels, a formed one-piece left trailing edge, right upper and lower skin panels, and right inboard and outboard formed trailing edges. The elevator trim tab consists of a bracket assembly, hinge half, and a wrap-around skin panel. Both elevator tip leading edge extensions incorporate balance weights.

FLIGHT CONTROLS

The airplane's flight control system (see figure 7-1) consists of conventional aileron, elevator and rudder control surfaces. The control surfaces are manually operated through mechanical linkage using a control wheel for the ailerons and elevator, and rudder/brake pedals for the rudder. The elevator control system is equipped with downsprings which provide improved stability in flight.

Stowable right-hand rudder pedals may be installed. The pedals fold forward and stow against the firewall, thereby permitting the front passenger to extend his feet forward for greater comfort. A push-pull control on the instrument panel actuates the pedal unlocking mechanism. The pedals are stowed by squeezing the double buttons of the control knob and pulling the knob out to release the pedals; the pedals can then be pushed forward against the firewall where they are retained by spring clips within a bracket. The pedals are restored to their operating positions by pushing the control knob full in, inserting the toe of the shoe underneath each pedal, and pulling each pedal aft until it snaps into position. The pedals are again ready for flight use by the right front passenger.

Extensions are available for the rudder/brake pedals. They consist of a rudder pedal face, two spacers and two spring clips. To install an extension, place the clip on the bottom of the extension under the bottom of the rudder pedal and snap the top clip over the top of the rudder pedal. Check that the extension is firmly in place. To remove the extensions, reverse the above procedures.

TRIM SYSTEMS

Manually-operated rudder and elevator trim is provided (see figure 7-1). Rudder trimming is accomplished through a bungee connected to the rudder control system and a trim control wheel mounted on the control pedestal. Rudder trimming is accomplished by rotating the horizontally mounted trim control wheel either left or right to the desired trim position. Rotating the trim wheel to the right will trim nose-right; conversely, rotating it to the left will trim nose-left. Elevator trimming is accomp-

lished through the elevator trim tab by utilizing the vertically mounted trim control wheel. Forward rotation of the trim wheel will trim nose-down; conversely, aft rotation will trim nose-up. The airplane may also be equipped with an electric elevator trim system. For details concerning this system, refer to Section 9, Supplements.

INSTRUMENT PANEL

The instrument panel (see figure 7-2) is designed around the basic "T" configuration. The gyros are located immediately in front of the pilot, and arranged vertically. The airspeed indicator and altimeter are located to the left and right of the gyros respectively. The remainder of the flight instruments are located around the basic "T". Avionics equipment is stacked approximately on the centerline of the panel, with the right side of the panel containing the manifold pressure/fuel flow indicator, tachometer, map compartment, and space for additional instruments and avionics equipment. The engine instrument cluster, fuel quantity indicators, and suction gage are on the right side of the avionics stack near the top of the panel. A switch and control panel, at the lower edge of the instrument panel, contains most of the switches, controls, and circuit breakers necessary to operate the airplane. The left side of the panel contains the master switch, auxiliary fuel pump switch, ignition switch, light intensity controls, avionics power switch, electrical switches, and circuit breakers. The center area contains the throttle, propeller control, and mixture control. The right side of the panel contains the wing flap switch and indicator, cabin heat, cabin air, defroster, auxiliary cabin air, and stowable rudder pedal control knobs and the cigar lighter. A pedestal, extending from the edge of the switch and control panel to the floorboard, contains the elevator and rudder trim control wheels, cowl flap control lever, engine primer and microphone bracket. The fuel selector valve handle is located at the base of the pedestal. A parking brake handle is mounted under the switch and control panel, in front of the pilot. A static pressure alternate static source valve may also be installed beneath the switch and control panel.

For details concerning the instruments, switches, circuit breakers, and controls on this panel, refer in this section to the description of the systems to which these items are related.

GROUND CONTROL

Effective ground control while taxiing is accomplished through nose wheel steering by using the rudder pedals; left rudder pedal to steer left and right rudder pedal to steer right. When a rudder pedal is depressed, a spring-loaded steering bungee (which is connected to the nose gear and to the rudder bars) will turn the nose wheel through an arc of approximately

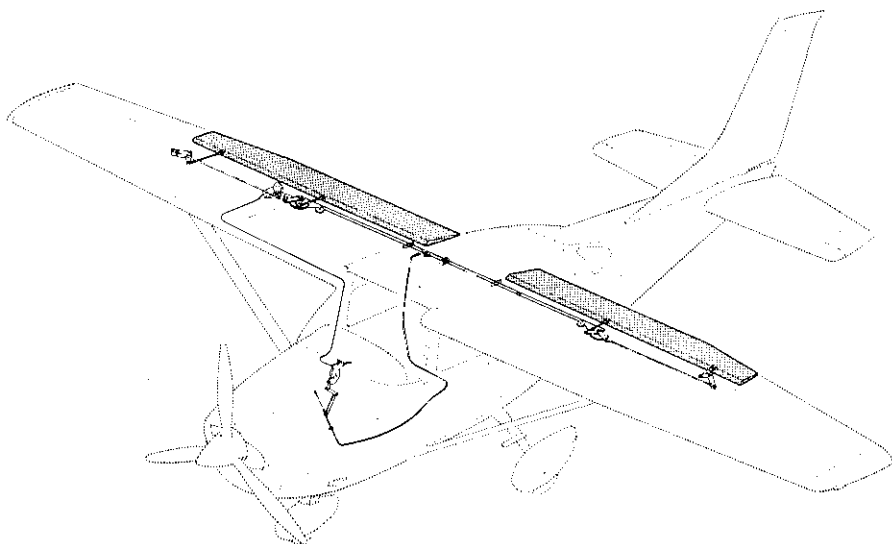

Figure 7-3. Wing Flap System

15° each side of center. By applying either left or right brake, the degree of turn may be increased up to 35° each side of center.

Moving the airplane by hand is most easily accomplished by attaching a tow bar to the nose gear strut. If a tow bar is not available, or pushing is required, use the wing struts as push points. Do not use the vertical or horizontal tail surfaces to move the airplane. If the airplane is to be towed by vehicle, never turn the nose wheel more than 35° either side of center or structural damage to the nose gear could result.

The minimum turning radius of the airplane, using differential braking and nose wheel steering during taxi, is approximately 25 feet.

WING FLAP SYSTEM

The wing flaps are of the large span, single-slot type (see figure 7-3), and are extended or retracted by positioning the wing flap switch lever on the instrument panel to the desired flap deflection position. The switch lever is moved up or down in a slotted panel that provides mechanical stops at the 10° and 20° positions. For flap settings greater than 10°, move the switch lever to the right to clear the stop and position it as desired. A scale and pointer on the left side of the switch lever indicates flap travel in degrees. The wing flap system circuit is protected by a 10-ampere circuit

breaker, labeled FLAP, on the left side of the instrument panel.

LANDING GEAR SYSTEM

The landing gear is of the tricycle type with a steerable nose wheel, two main wheels, and wheel fairings. Shock absorption is provided by the flat leaf spring-steel main landing gear struts and the air/oil nose gear shock strut. Each main gear wheel is equipped with a hydraulically actuated disc-type brake on the inboard side of each wheel. An aerodynamic fairing covers each brake.

BAGGAGE COMPARTMENT

The baggage compartment consists of the area from the back of the rear passenger seats to the aft cabin bulkhead. Access to the baggage compartment is gained through the cargo doors on the right side of the airplane, or from within the airplane cabin. A baggage net with six tie-down straps is provided for securing baggage and is attached by tying the straps to tie-down rings provided in the airplane. When utilizing the airplane as a cargo carrier, refer to Section 6 for complete cargo loading details. When loading the airplane, children should not be placed or permitted in the baggage compartment, and any material that might be hazardous to the airplane or occupants should not be placed anywhere in the airplane. For baggage/cargo area and door dimensions, refer to Section 6.

SEATS

The airplane may be equipped with either the conventional or club style six seat arrangement. Conventional seating consists of six separate four-way adjustable seats, and the club style seating utilizes four forward facing four-way adjustable seats and two aft facing two-way adjustable seats. The pilot's and front passenger's seats are also available in a six-way adjustable configuration.

A club style seating arrangement featuring two aft facing two-way adjustable seats in the center passenger seat positions may be installed in the airplane. Details of this installation are presented in Section 9, Supplements.

The four-way seats, used with the conventional and club style seating arrangements, may be moved forward and aft, and the seat back angle changed. Position the seat by lifting up on the tubular handle under the

center of the seat bottom of the pilot's and front passenger's seats, or the handle under the left front corner of the center passengers' and the rear passengers' seats and slide the seat into position; then release the handle and check that the seat is locked in place. The seat back angle is adjusted using a cylinder lock release button located on the left front corner of the pilot's and front passenger's seat, or the right front corner of the center passengers' seats. To adjust the seat back angle, push up on the cylinder lock release button, position the seat back to the desired angle and release the button. When the seat is not occupied, the seat back will automatically fold forward whenever the cylinder lock release button is pushed up. The aft passengers' seat back angle is adjusted by lifting a lever on the left rear corner of each seat.

The six-way adjustable pilot's or front passenger's seat may be moved forward or aft, adjusted for height, and the seat back angle is infinitely adjustable. Position the seat by lifting the tubular handle, under the center of the seat bottom, and slide the seat into position; then release the handle and check that the seat is locked in place. Raise or lower the seat by rotating a large crank under the front inboard corner of the seat. Seat back angle is adjustable by rotating a small crank under the front outboard corner of the seat. The seat bottom angle will change as the seat back angle changes, providing proper support. The seat back will also fold full forward.

Headrests are available for all seat configurations. To adjust the headrest, apply enough pressure to it to raise or lower it to the desired level. The headrest may be removed by raising it until it disengages from the top of the seat back.

SEAT BELTS AND SHOULDER HARNESSSES

All seat positions are equipped with seat belts (see figure 7-4). The pilot's and front passenger's seats are also equipped with separate shoulder harnesses; separate shoulder harnesses are available for the remaining seat positions. If club seating is installed, no shoulder harness is available for the aft facing seats. Integrated seat belt/shoulder harnesses with inertia reels can be furnished for the pilot's and front passenger's seat positions if desired.

SEAT BELTS

The seat belts for all seat positions are attached to fittings on the floorboard. However, if club seating is installed, the seat belts for the aft facing seats are attached to the seat frame. The buckle half is inboard of each seat and the link half is outboard of each seat.

STANDARD SHOULDER
HARNESS

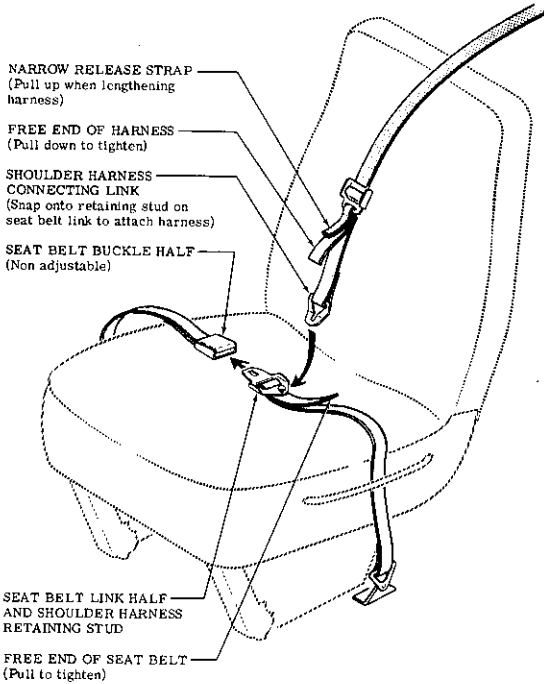

SEAT BELT/SHOULDER
HARNESS WITH INERTIA
REEL

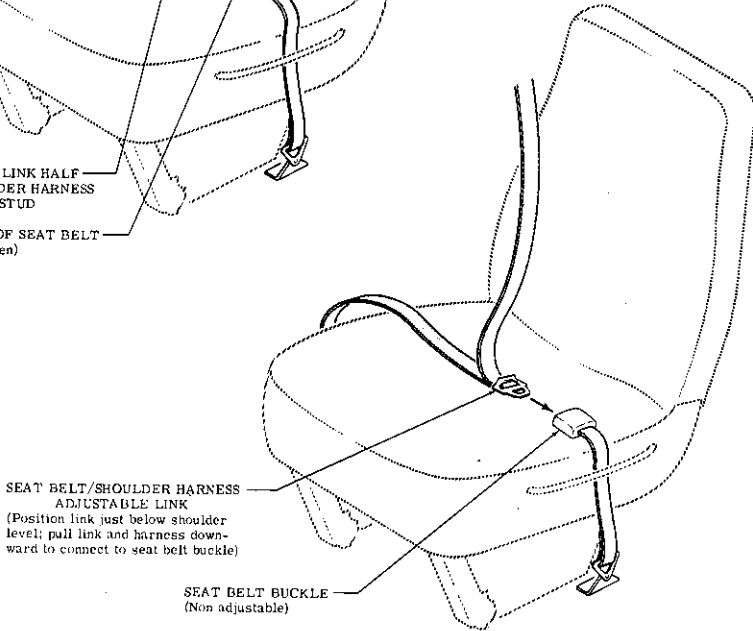

Figure 7-4. Seat Belts and Shoulder Harnesses

To use the seat belts, position the seat as desired, and then lengthen the link half of the belt as needed by grasping the sides of the link and pulling against the belt. Insert and lock the belt link into the buckle. Tighten the belt to a snug fit. To release the seat belts, grasp the top of the buckle opposite the link and pull upward.

SHOULDER HARNESSSES

Each front seat shoulder harness is attached above the aft edge of the front side window and is stowed behind a stowage sheath mounted above the side window. To stow the harness, fold it and place it behind the sheath. If the center and rear seats are equipped with shoulder harnesses, the center seat harnesses are attached above the window line aft of the seats and the rear seat harnesses are attached below the rear window. Center seat harnesses are stowed behind wire retaining clips above the window line, and rear seat harnesses are stowed behind clips located aft of the rear seats below the window line.

To use the shoulder harness, fasten and adjust the seat belt first. Lengthen the harness as required by pulling on the connecting link on the end of the harness and the narrow release strap. Snap the connecting link firmly onto the retaining stud on the seat belt link half. Then adjust to length. A properly adjusted harness will permit the occupant to lean forward enough to sit completely erect, but prevent excessive forward movement and contact with objects during sudden deceleration. Also, the pilot will want the freedom to reach all controls easily.

Removing the shoulder harness is accomplished by pulling upward on the narrow release strap, and removing the harness connecting link from the stud on the seat belt link. In an emergency, the shoulder harness may be removed by releasing the seat belt first and allowing the harness, still attached to the link half of the seat belt, to drop to the side of the seat.

INTEGRATED SEAT BELT/SHOULDER HARNESSSES WITH INERTIA REELS

Integrated seat belt/shoulder harnesses with inertia reels are available for the pilot and front seat passenger. The seat belt/shoulder harnesses extend from inertia reels located in the cabin top structure, through slots in the overhead console marked PILOT and COPILOT, to attach points inboard of the two front seats. A separate seat belt half and buckle is located outboard of the seats. Inertia reels allow complete freedom of body movement. However, in the event of a sudden deceleration, they will lock automatically to protect the occupants.

To use the seat belt/shoulder harness, position the adjustable metal link on the harness just below shoulder level, pull the link and harness

downward, and insert the link in the seat belt buckle. Adjust belt tension across the lap by pulling upward on the shoulder harness. Removal is accomplished by releasing the seat belt buckle, which will allow the inertia reel to pull the harness inboard of the seat.

ENTRANCE DOORS AND CABIN WINDOWS

Entry to, and exit from the airplane is accomplished through an entry door on the left side of the cabin at the pilot's seat position and through double cargo doors on the right side of the cabin at the center and rear seat passenger's positions (refer to Section 6 for cabin and cabin door dimensions). The left entry door incorporates a recessed exterior door handle, a conventional interior door handle, a key-operated door lock, a door stop mechanism, and an openable window. The forward cargo door is equipped with a recessed exterior door handle, conventional interior door handle, a key-operated door lock, and a door stop mechanism. The aft door utilizes a locking pawl on the top and bottom of the door near the forward edge, a red handle on the forward edge of the door, and a door stop mechanism.

To open the left entry door from outside the airplane, utilize the recessed door handle near the aft edge of the door. Grasp the forward end of the handle and pull outboard. To open or close the door from inside the airplane, use the conventional door handle and arm rest. The inside door handle is a three-position handle having a placard at its base with the positions OPEN, CLOSE, and LOCK shown on it. The handle is spring-loaded to the CLOSE (up) position. When the door has been pulled shut and latched, lock it by rotating the door handle forward to the LOCK position (flush with the arm rest). When the handle is rotated to the LOCK position, an over-center action will hold it in that position. The door should be locked prior to flight, and should not be opened intentionally during flight.

NOTE

Accidental opening of the cabin door in flight due to improper closing does not constitute a need to land the airplane. The best procedure is to set up the airplane in a trimmed condition at approximately 90 knots, momentarily shove the door outward slightly, and forcefully close and lock the door. If the forward cargo door should come unlatched and open slightly in flight, it is suggested that a landing be made at a suitable airport to close and latch the door, unless a passenger is available to close it. It cannot be reached by the pilot. It should be remembered that the wing flaps will not operate with the cargo door open, even very slightly, and the landing should be planned accordingly.

The double cargo doors are opened from outside the airplane by utilizing the recessed door handle near the aft edge of the forward door. Depress the forward end of the handle to rotate it out of its recess, and then pull outboard. After the forward door is opened, the aft door may be opened by grasping the red handle on the forward edge of the door and pulling downward to release the locking pawls. To close the cargo doors from inside the airplane, close the aft door first, with enough force to latch both locking pawls, and then close the forward door. When the forward door is closed and latched, rotate the door handle, labeled OPEN, CLOSE, and LOCK, to the locked position. Both doors must be securely closed and the forward door locked prior to flight, and they must not be opened intentionally during flight.

NOTE

A flap interrupt switch, on the upper sill of the forward cargo door opening, will stop flap operation regardless of flap position any time the forward cargo door is unlatched. The switch is intended to prevent lowering the flaps into the cargo door when it is open.

Flight operations with the cargo doors removed are not approved, unless a depressor plate is installed over the wing flap interrupt switch and a spoiler is installed on the forward edge of the cargo door opening. With the cargo doors removed and the above items installed, flight is restricted to 130 knots.

If necessary, the outside door handle can be used to lock the forward cargo door. Simply lift the handle out of its recess and grasp the vertical tab of the connecting link behind the handle. Pull the tab outboard until the connecting link engages a detent at its aft end. Push the handle back into its recess while observing the inside handle rotating toward the locked position through the cargo door window. The inside handle will not rotate fully forward.

CAUTION

If the cargo door is closed from the outside with passengers occupying the middle or rear seat rows, the inside door handle must be rotated fully forward to disengage the outside closing mechanism and allow the door to be opened from the inside.

The left entry door and the forward cargo door have key-operated locks which may be used to secure the aircraft during parking.

NOTE

Since the key-operated outside lock engages the door handle only, the forward cargo door cannot be secured for flight using only the key lock.

The left entry door is equipped with an openable window which is held in the closed position by a detent equipped latch on the lower edge of the window frame. To open the window, rotate the latch upward. The window utilizes a spring-loaded retaining arm which will help rotate the window outward and hold it there. An openable window is also available for the right front passenger's seat position, and functions in the same manner as

the window in the entry door. If required, either window may be opened at any speed up to 183 KIAS. All other cabin windows are of the fixed type and cannot be opened.

CONTROL LOCKS

A control lock is provided to lock the aileron and elevator control surfaces to prevent damage to these systems by wind buffeting while the airplane is parked. The lock consists of a shaped steel rod with a red metal flag attached to it. The flag is labeled CONTROL LOCK, REMOVE BEFORE STARTING ENGINE. To install the control lock, align the hole on the right side of the pilot's control wheel shaft with the hole in the right side of the shaft collar on the instrument panel and insert the rod into the aligned holes. Installation of the lock will secure the ailerons in a neutral position and the elevators in a slightly trailing edge down position. Proper installation of the lock will place the red flag over the ignition switch. In areas where high or gusty winds occur, a control surface lock should be installed over the vertical stabilizer and rudder. The control lock and any other type of locking device should be removed prior to starting the engine.

ENGINE

The airplane is powered by a horizontally-opposed, six-cylinder, overhead-valve, air-cooled, fuel injection engine with a wet sump oil system. The engine is a Continental Model IO-520-F and is rated at 300 horsepower at 2850 RPM for five minutes and 285 horsepower at 2700 RPM continuous. Major accessories include a propeller governor on the front of the engine and dual magnetos, starter, and belt-driven alternator on the rear of the engine. Provisions are also made for a vacuum pump and a full flow oil filter.

ENGINE CONTROLS

Engine manifold pressure is controlled by a throttle located on the lower center portion of the instrument panel. The throttle operates in a conventional manner; in the full forward position, the throttle is open, and in the full aft position, it is closed. A friction lock, which is a round knurled disk, is located at the base of the throttle and is operated by rotating the lock clockwise to increase friction or counterclockwise to decrease it.

The mixture control, mounted above the right corner of the control pedestal, is a red knob with raised points around the circumference and is equipped with a lock button in the end of the knob. The rich position is full forward, and full aft is the idle cut-off position. For small adjustments, the control may be moved forward by rotating the knob clockwise, and aft by

rotating the knob counterclockwise. For rapid or large adjustments, the knob may be moved forward or aft by depressing the lock button in the end of the control, and then positioning the control as desired.

ENGINE INSTRUMENTS

Engine operation is monitored by the following instruments: oil pressure gage, oil temperature gage, cylinder head temperature gage, tachometer, and manifold pressure/fuel flow indicator. An economy mixture (EGT) indicator is also available.

The oil pressure gage, located on the upper right side of the instrument panel, is operated by oil pressure. A direct pressure oil line from the engine delivers oil at engine operating pressure to the oil pressure gage. Gage markings indicate that minimum idling pressure is 10 PSI (red line), the normal operating range is 30 to 60 PSI (green arc), and maximum pressure is 100 PSI (red line).

Oil temperature is indicated by a gage adjacent to the oil pressure gage. The gage is operated by an electrical-resistance type temperature sensor which receives power from the airplane electrical system. Gage markings indicate the normal operating range (green arc) which is 100°F (38°C) to 240°F (116°C), and the maximum (red line) which is 240°F (116°C).

The cylinder head temperature gage, under the left fuel quantity indicator, is operated by an electrical-resistance type temperature sensor on the engine which receives power from the airplane electrical system. Gage markings indicate the normal operating range (green arc) which is 200°F (93°C) to 460°F (238°C) and the maximum (red line) which is 460°F (238°C).

The engine-driven mechanical tachometer is located on the lower right side of the instrument panel. The instrument is calibrated in increments of 100 RPM and indicates both engine and propeller speed. An hour meter below the center of the tachometer dial records elapsed engine time in hours and tenths. Instrument markings include a normal operating range (green arc) of 2200 to 2550 RPM, a five minute maximum power range (yellow arc) of 2700 to 2850 RPM, and a maximum (red line) of 2850 RPM.

The manifold pressure gage is the left half of a dual-indicating instrument mounted above the tachometer. The gage is direct reading and indicates induction air manifold pressure in inches of mercury. It has a normal operating range (green arc) of 15 to 25 inches of mercury.

The fuel flow indicator is the right half of a dual-indicating instrument mounted above the tachometer. The indicator is a fuel pressure gage calibrated to indicate the approximate gallons per hour of fuel being

metered to the engine. The normal operating range (green arc) is from 7 to 17 gallons per hour, the minimum (red line) is 3.5 PSI, and the maximum (red line) is 25.2 gallons per hour (19.5 PSI).

An economy mixture (EGT) indicator is available for the airplane and is located on the right side of the instrument panel. A thermocouple probe in the right exhaust collector measures exhaust gas temperature and transmits it to the indicator. The indicator serves as a visual aid to the pilot in adjusting cruise mixture. Exhaust gas temperature varies with fuel-to-air ratio, power, and RPM. However, the difference between the peak EGT and the EGT at the cruise mixture setting is essentially constant and this provides a useful leaning aid. The indicator is equipped with a manually positioned reference pointer.

NEW ENGINE BREAK-IN AND OPERATION

The engine underwent a run-in at the factory and is ready for the full range of use. It is, however, suggested that cruising be accomplished at 65% to 75% power until a total of 50 hours has accumulated or oil consumption has stabilized. This will ensure proper seating of the rings.

The airplane is delivered from the factory with corrosion preventive oil in the engine. If, during the first 25 hours, oil must be added, use only aviation grade straight mineral oil conforming to Specification No. MIL-L-6082.

ENGINE OIL SYSTEM

Oil for engine lubrication and propeller governor operation is supplied from a sump on the bottom of the engine. The capacity of the engine sump is 12 quarts (one additional quart is contained in the engine oil filter, if installed). Oil is drawn from the sump through a filter screen on the end of a pickup tube to the engine-driven oil pump. Oil from the pump passes through a pressure screen (full flow oil filter, if installed), a pressure relief valve at the rear of the right oil gallery, and a thermostatically controlled oil cooler. Oil from the cooler is then circulated to the left gallery and propeller governor. The engine parts are then lubricated by oil from the galleries. After lubricating the engine, the oil returns to the sump by gravity. If a full flow oil filter is installed, the filter adapter is equipped with a bypass valve which will cause lubricating oil to bypass the filter in the event the filter becomes plugged, or the oil temperature is extremely cold.

An oil dipstick is located at the rear of the engine on the left side, and an oil filler tube is on top of the crankcase near the front of the engine. The dipstick and oil filler are accessible through doors on the engine cowling. The engine should not be operated on less than 9 quarts of oil. To minimize

loss of oil through the breather, fill to 10 quarts for normal flights of less than three hours. For extended flight, fill to 12 quarts (dipstick indication only). For engine oil grade and specifications, refer to Section 8 of this handbook.

The oil cooler may be replaced by a non-congealing oil cooler for operations in temperatures consistently below 20°F (-7°C). The non-congealing oil cooler provides improved oil flow at low temperatures. Once installed, the non-congealing oil cooler is approved for permanent use in both hot and cold weather.

An oil quick-drain valve is available to replace the drain plug on the bottom of the oil sump, and provides quicker, cleaner draining of the engine oil. To drain the oil with this valve, slip a hose over the end of the valve and push upward on the end of the valve until it snaps into the open position. Spring clips will hold the valve open. After draining, use a suitable tool to snap the valve into the extended (closed) position and remove the drain hose.

IGNITION-STARTER SYSTEM

Engine ignition is provided by two engine-driven magnetos and two spark plugs in each cylinder. The right magneto fires the lower left and upper right spark plugs, and the left magneto fires the lower right and upper left spark plugs. Normal operation is conducted with both magnetos due to the more complete burning of the fuel-air mixture with dual ignition.

Ignition and starter operation is controlled by a rotary type switch located on the left switch and control panel. The switch is labeled clockwise, OFF, R, L, BOTH, and START. The engine should be operated on both magnetos (BOTH position) except for magneto checks. The R and L positions are for checking purposes and emergency use only. When the switch is rotated to the spring-loaded START position, (with the master switch in the ON position), the starter contactor is energized and the starter will crank the engine. When the switch is released, it will automatically return to the BOTH position.

AIR INDUCTION SYSTEM

The engine air induction system receives ram air through the left intake in the front of the engine cowling. Aft of the engine cylinders is an air filter which removes dust and other foreign matter from the induction air. Airflow passing through the filter enters an airbox at the rear of the engine. The airbox has a spring-loaded alternate air door. If the air induction filter should become blocked, suction created by the engine will open the door and draw unfiltered air from inside the upper cowl area. An open alternate air door will result in an approximate 10% power loss at full

throttle. After passing through the airbox, induction air enters a fuel/air control unit behind the engine, and is then ducted to the engine cylinders through intake manifold tubes.

EXHAUST SYSTEM

Exhaust gas from each cylinder passes through riser assemblies to a collector and muffler on each side of the engine. The left muffler is constructed with a shroud around the outside which forms a heating chamber for cabin heater air.

FUEL INJECTION SYSTEM

The engine is equipped with a fuel injection system. The system comprised of an engine-driven fuel pump, fuel/air control unit, fuel manifold, fuel flow indicator, and air-bleed type injector nozzles.

Fuel is delivered by the engine-driven fuel pump to the fuel/air control unit behind the engine. The fuel/air control unit correctly proportions the fuel flow to the induction air flow. After passing through the control unit, induction air is delivered to the cylinders through intake manifold tubes, and metered fuel is delivered to a fuel manifold. The fuel manifold, through spring tension on a diaphragm and valve, evenly distributes the fuel to an air-bleed type injector nozzle in the intake valve chamber of each cylinder. A pressure line is also attached to the fuel manifold, and is connected to a fuel flow indicator on the instrument panel.

COOLING SYSTEM

Ram air for engine cooling enters through two intake openings in the front of the engine cowling. The cooling air is directed around the cylinders and other areas of the engine by baffling, and is then exhausted through cowl flaps on the lower aft edge of the cowling. The cowl flaps are mechanically operated from the cabin by means of a cowl flap lever on the right side of the control pedestal. The pedestal is labeled COWL FLAP, OPEN, CLOSED. During takeoff and high power operation, the cowl flap lever should be placed in the OPEN position for maximum cooling. This is accomplished by moving the lever to the right to clear a detent, then moving the lever up to the OPEN position. Anytime the lever is repositioned, it must first be moved to the right. While in cruise flight, cowl flaps should be adjusted to keep the cylinder head temperature at approximately two-thirds of the normal operating range (green arc). During extended let-downs, it may be necessary to completely close the cowl flaps by pushing the cowl flap lever down to the CLOSED position.

A winterization kit is available for the airplane. Details of this kit are presented in Section 9, Supplements.

PROPELLER

The airplane has an all-metal, three-bladed, constant-speed, governor-regulated propeller. A setting introduced into the governor with the propeller control establishes the propeller speed, and thus the engine speed to be maintained. The governor then controls flow of engine oil, boosted to high pressure by the governing pump, to or from a piston in the propeller hub. Oil pressure acting on the piston twists the blades toward high pitch (low RPM). When oil pressure to the piston in the propeller hub is relieved, centrifugal force, assisted by an internal spring, twists the blades toward low pitch (high RPM).

A control knob on the lower center portion of the instrument panel is used to set the propeller and control engine RPM as desired for various flight conditions. The knob is labeled PROP PITCH PUSH INCR RPM. When the control knob is pushed in, blade pitch will decrease, giving a higher RPM. When the control knob is pulled out, the blade pitch increases, thereby decreasing RPM. The propeller control knob is equipped with a vernier feature which allows slow or fine RPM adjustments by rotating the knob clockwise to increase RPM, and counterclockwise to decrease it. To make rapid or large adjustments, depress the button on the end of the control knob and reposition the control as desired.

FUEL SYSTEM

The airplane fuel system (see figure 7-5) consists of two vented integral fuel tanks (one in each wing), two fuel reservoir tanks, a fuel tank selector valve, auxiliary fuel pump, fuel strainer, engine-driven fuel pump, fuel/air control unit, fuel manifold, and fuel injector nozzles.

NOTE

Unusable fuel is at a minimum due to the design of the fuel system. However, with 1/4 tank or less, prolonged uncoordinated flight such as slips or skids can uncover the fuel tank outlets, causing fuel starvation and engine stoppage. Therefore, with low fuel reserves, do not allow the airplane to remain in uncoordinated flight for periods in excess of one minute.

Fuel flows by gravity from the two wing tanks to two reservoir tanks, and from the reservoir tanks to a three-position selector valve labeled LEFT ON, RIGHT ON, and OFF. With the selector valve in the LEFT ON or RIGHT ON position, fuel from either the left or right tank flows through a bypass in the auxiliary fuel pump (when it is not in operation), and through a strainer in an engine-driven fuel pump. The engine-driven fuel pump delivers the fuel to the fuel/air control unit where it is metered and directed

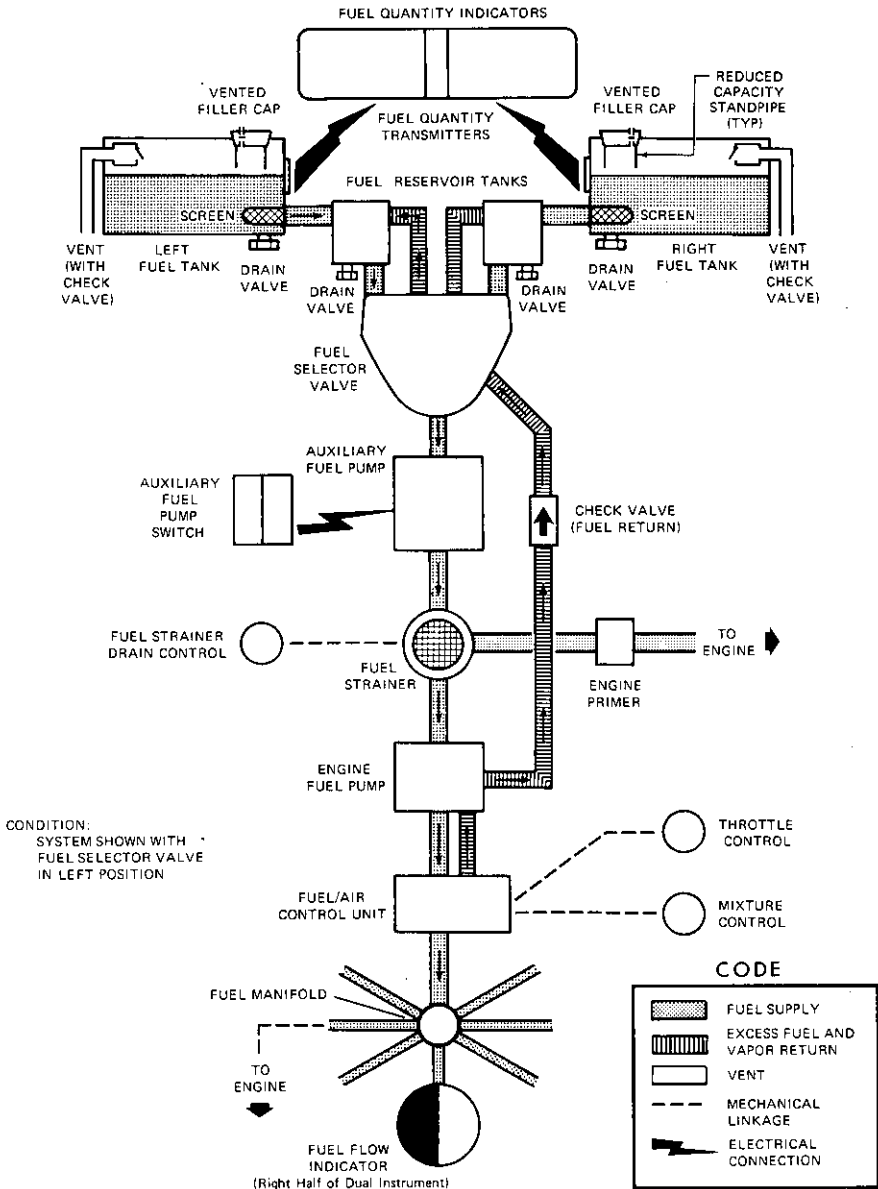

Figure 7-5. Fuel System

FUEL QUANTITY DATA (U. S. GALLONS)			
TANKS	TOTAL USABLE FUEL ALL FLIGHT CONDITIONS	TOTAL UNUSABLE FUEL	TOTAL FUEL VOLUME
STANDARD (46 Gal. Each)	88	4	92 <i>348</i>
REDUCED FUEL (34.5 Gal. Each)	65	4	69

Figure 7-6. Fuel Quantity Data

to a manifold which distributes it to each cylinder.

NOTE

Fuel cannot be used from both fuel tanks simultaneously.

Vapor and excess fuel from the engine-driven fuel pump and fuel/air control unit are returned by way of the selector valve to the reservoir tank of the wing fuel tank system being used.

Fuel system venting is essential to system operation. Complete blockage of the venting system will result in decreasing fuel flow and eventual engine stoppage. Venting is accomplished by check valve equipped vent lines, one from each fuel tank, which protrude from the bottom surface of each wing at the wing strut attach point. The fuel filler caps are equipped with vacuum operated vents which open, allowing air into the tanks, should the fuel tank vent lines become blocked.

Fuel quantity is measured by two float-type fuel quantity transmitters (one in each tank) and indicated by two electrically-operated fuel quantity indicators on the right side of the instrument panel. The fuel quantity indicators are calibrated in gallons (lower scale) and pounds (upper scale). An empty tank is indicated by a red line and the letter E. When an indicator shows an empty tank, approximately 2.0 gallons remain in the tank as unusable fuel. The indicators cannot be relied upon for accurate readings during skids, slips, or unusual attitudes. If both indicator pointers should rapidly move to a zero reading, check the cylinder head temperature and oil temperature gages for operation. If these gages are not indicating, an electrical malfunction has occurred.

The airplane may be serviced to a reduced capacity to permit heavier cabin loadings. This is accomplished by filling each tank to the bottom edge of the fuel filler collar, thus giving a reduced fuel load of 34.5 gallons

in each tank (32.5 gallons usable in all flight conditions).

The auxiliary fuel pump switch is located on the left side of the instrument panel and is a yellow and red split-rocker type switch. The yellow right half of the switch is labeled START, and its upper ON position is used for normal starting, minor vapor purging and continued engine operation in the event of an engine-driven fuel pump failure. With the right half of the switch in the ON position, the pump operates at one of two flow rates that are dependent upon the setting of the throttle. With the throttle open to a cruise setting, the pump operates at a high enough capacity to supply sufficient fuel flow to maintain flight with an inoperative engine-driven fuel pump. When the throttle is moved toward the closed position (as during letdown, landing, and taxiing), the fuel pump flow rate is automatically reduced, preventing an excessively rich mixture during these periods of reduced engine speed.

NOTE

If the engine-driven fuel pump is functioning and the auxiliary fuel pump switch is placed in the ON position, an excessively rich fuel/air ratio is produced unless the mixture is leaned. Therefore, this switch should be turned off during takeoff.

NOTE

If the auxiliary fuel pump switch is accidentally placed in the ON position with the master switch on and the engine stopped, the intake manifolds will be flooded.

The red left half of the switch is labeled EMERG, and its upper HI position is used in the event of an engine-driven fuel pump failure during takeoff or high power operation. The HI position may also be used for extreme vapor purging. Maximum fuel flow is produced when the left half of the switch is held in the spring-loaded HI position. In this position, an interlock within the switch automatically trips the right half of the switch to the ON position. When the spring-loaded left half of the switch is released, the right half will remain in the ON position until manually returned to the off position.

If it is desired to completely exhaust a fuel tank quantity in flight, the auxiliary fuel pump will be needed to assist in restarting the engine when fuel exhaustion occurs. Therefore, it is recommended that proper operation of the auxiliary fuel pump be verified prior to running a fuel tank dry by turning the auxiliary fuel pump ON momentarily and checking for a slight rise in fuel flow indication.

To ensure a prompt engine restart in flight after running a fuel tank dry, immediately switch to the tank containing fuel at the first indication of

fuel pressure fluctuation and/or power loss. Then place the right half of the auxiliary fuel pump switch in the ON position momentarily (3 to 5 seconds) with the throttle at least 1/2 open. Excessive use of the ON position at high altitude and full rich mixture can cause flooding of the engine as indicated by a short (1 to 2 seconds) period of power followed by a loss of power. This can later be detected by a fuel flow indication accompanied by a lack of power. If flooding does occur, turn off the auxiliary fuel pump switch, and normal propeller windmilling should start the engine in 1 to 2 seconds.

If the propeller should stop (possible at very low airspeeds) before the tank containing fuel is selected, place the auxiliary fuel pump switch in the ON position and advance the throttle promptly until the fuel flow indicator registers approximately 1/2 way into the green arc for 1 to 2 seconds duration. Then retard the throttle, turn off the auxiliary fuel pump, and use the starter to turn the engine over until a start is obtained.

The fuel system is equipped with drain valves to provide a means for the examination of fuel in the system for contamination and grade. The system should be examined before the first flight of every day and after each refueling, by using the sampler cup provided to drain fuel from the wing tank sumps, and by utilizing the fuel strainer drain under an access panel on the left side of the engine cowling. Quick-drain valves are also provided for the fuel reservoir tanks. The valves are located under plug buttons in the belly skin of the airplane, and are used to facilitate purging of the fuel system in the event water is discovered during the preflight fuel system inspection. The fuel tanks should be filled after each flight to prevent condensation.

BRAKE SYSTEM

The airplane has a single-disc, hydraulically-actuated brake on each main landing gear wheel. Each brake is connected, by a hydraulic line, to a master cylinder attached to each of the pilot's rudder pedals. The brakes are operated by applying pressure to the top of either the left (pilot's) or right (copilot's) set of rudder pedals, which are interconnected. When the airplane is parked, both main wheel brakes may be set by utilizing the parking brake which is operated by a handle under the left side of the instrument panel. To apply the parking brake, set the brakes with the rudder pedals, pull the handle aft, and rotate it 90° down.

For maximum brake life, keep the brake system properly maintained, and minimize brake usage during taxi operations and landings.

Some of the symptoms of impending brake failure are: gradual

decrease in braking action after brake application, noisy or dragging brakes, soft or spongy pedals, and excessive travel and weak braking action. If any of these symptoms appear, the brake system is in need of immediate attention. If, during taxi or landing roll, braking action decreases, let up on the pedals and then re-apply the brakes with heavy pressure. If the brakes become spongy or pedal travel increases, pumping the pedals should build braking pressure. If one brake becomes weak or fails, use the other brake sparingly while using opposite rudder, as required, to offset the good brake.

ELECTRICAL SYSTEM

The airplane is equipped with a 28-volt, direct-current electrical system (see figure 7-7). The system uses a battery, located on the upper left forward portion of the firewall, as the source of electrical energy and a belt-driven, 60-amp alternator to maintain the battery's state of charge. Power is supplied to most general electrical and all avionics circuits through the primary bus bar and the avionics bus bar, which are interconnected by an avionics power switch. The primary bus is on anytime the master switch is turned on, and is not affected by starter or external power usage. Both bus bars are on anytime the master and avionics power switches are turned on.

CAUTION

Prior to turning the master switch on or off, starting the engine, or applying an external power source, the avionics power switch, labeled AVIONICS POWER, should be turned off to prevent any harmful transient voltage from damaging the avionics equipment.

MASTER SWITCH

The master switch is a split-rocker type switch labeled MASTER, and is ON in the up position and off in the down position. The right half of the switch, labeled BAT, controls all electrical power to the airplane. The left half, labeled ALT, controls the alternator.

Normally, both sides of the master switch should be used simultaneously; however, the BAT side of the switch could be turned ON separately to check equipment while on the ground. To check or use avionics equipment or radios while on the ground, the avionics power switch must be turned on. The ALT side of the switch, when placed in the off position, removes the alternator from the electrical system. With this switch in the off position, the entire electrical load is placed on the battery. Continued operation with the alternator switch in the off position will reduce battery

SECTION 7
AIRPLANE & SYSTEMS DESCRIPTIONS

CESSNA
MODEL U206G

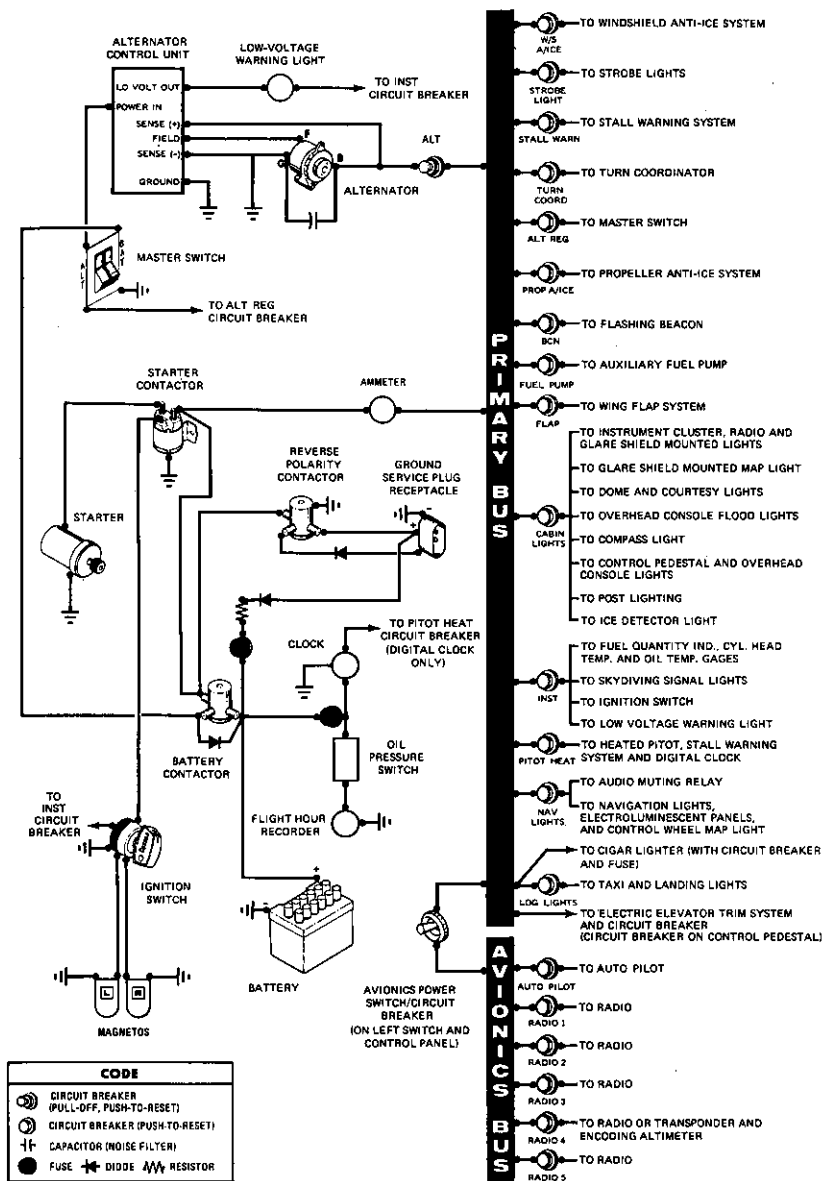

Figure 7-7. Electrical System

power low enough to open the battery contactor, remove power from the alternator field, and prevent alternator restart.

AVIONICS POWER SWITCH

Electrical power from the airplane primary bus to the avionics bus (see figure 7-7) is controlled by a toggle-type circuit breaker-switch labeled AVIONICS POWER. The switch is located on the left side of the switch and control panel and is ON in the up position and off in the down position. With the switch in the off position, no electrical power will be applied to the avionics equipment, regardless of the position of the master switch or the individual equipment switches. The avionics power switch also functions as a circuit breaker. If an electrical malfunction should occur and cause the circuit breaker to open, electrical power to the avionics equipment will be interrupted and the switch toggle will automatically move to the off position. If this occurs, allow the circuit breaker to cool approximately two minutes before placing the toggle in the on position again. If the circuit breaker opens again, do not reset it. The avionics power switch should be placed in the off position prior to turning the master switch on or off, starting the engine, or applying an external power source, and may be utilized in place of the individual avionics equipment switches.

AMMETER

The ammeter, located on the upper right portion of the instrument panel, indicates the amount of current, in amperes, from the alternator to the battery or from the battery to the airplane electrical system. When the engine is operating and the master switch is turned on, the ammeter indicates the charging rate applied to the battery. In the event the alternator is not functioning or the electrical load exceeds the output of the alternator, the ammeter indicates the battery discharge rate.

ALTERNATOR CONTROL UNIT AND LOW-VOLTAGE WARNING LIGHT

The airplane is equipped with a combination alternator regulator high-low voltage control unit mounted on the engine side of the firewall and a red warning light, labeled LOW VOLTAGE, under the oil temperature gage on the instrument panel.

In the event an over-voltage condition occurs, the alternator control unit automatically removes alternator field current which shuts down the alternator. The battery will then supply system current as shown by a discharge rate on the ammeter. Under these conditions, depending on electrical system load, the low-voltage warning light will illuminate when system voltage drops below normal. The alternator control unit may be

reset by turning the master switch off and back on again. If the warning light does not illuminate, normal alternator charging has resumed; however, if the light does illuminate again, a malfunction has occurred, and the flight should be terminated as soon as practicable.

NOTE

Illumination of the low-voltage light and ammeter discharge indications may occur during low RPM conditions with an electrical load on the system, such as during a low RPM taxi. Under these conditions, the light will go out at higher RPM. The master switch need not be recycled since an over-voltage condition has not occurred to de-activate the alternator system.

The warning light may be tested by turning on the landing lights and momentarily turning off the ALT portion of the master switch while leaving the BAT portion turned on.

CIRCUIT BREAKERS AND FUSES

Most of the electrical circuits in the airplane are protected by "push-to-reset" type circuit breakers mounted on the lower left side of the instrument panel. However, alternator output is protected by a "pull-off" type circuit breaker. The electric elevator trim system (if installed) is protected by a circuit breaker on the control pedestal. In addition to the individual circuit breakers, a toggle type circuit breaker-switch, labeled AVIONICS POWER, on the left switch and control panel also protects the avionics systems. The cigar lighter is protected a manually-reset type circuit breaker on the back of the lighter, and a fuse behind the instrument panel. The control wheel map light (if installed) is protected by the NAV LIGHTS circuit breaker and a fuse behind the instrument panel. Electrical circuits which are not protected by circuit breakers are the battery contactor closing (external power) circuit, clock circuit, and flight hour recorder circuit. These circuits are protected by fuses mounted adjacent to the battery.

GROUND SERVICE PLUG RECEPTACLE

A ground service plug receptacle may be installed to permit the use of an external power source for cold weather starting and during lengthy maintenance work on the electrical and electronic equipment. Details of the ground service plug receptacle are presented in Section 9, Supplements.

LIGHTING SYSTEMS

EXTERIOR LIGHTING

Conventional navigation lights are located on the wing tips and tail stinger, dual landing lights are installed in the cowl nose cap, and a flashing beacon is mounted on top of the vertical stabilizer. Additional lighting is available and includes a strobe light on each wing tip, two courtesy lights, one under each wing, just outboard of the cabin, and an ice detector light installed on the left side of the cowl deck forward of the windshield. Details of the strobe light system are presented in Section 9, Supplements. The courtesy lights are operated by a switch located on the left rear door post. All exterior lights, except the courtesy lights, are controlled by rocker type switches on the left switch and control panel. The switches are ON in the up position and off in the down position.

The flashing beacon should not be used when flying through clouds or overcast; the flashing light reflected from water droplets or particles in the atmosphere, particularly at night, can produce vertigo and loss of orientation.

INTERIOR LIGHTING

Instrument and control panel lighting is provided by flood, and integral lighting, with electroluminescent and post lighting also available. Rheostats and control knobs, located on the left switch and control panel, control the intensity of all lighting. The following paragraphs describe the various lighting systems and their controls.

The left and right sides of the switch and control panel, and the marker beacon/audio control panel may be lighted by electroluminescent panels which do not require light bulbs for illumination. To utilize this lighting, turn the NAV light rocker switch to the ON position and rotate the inner knob labeled EL PANEL, on the right dimming rheostat, clockwise to the desired light intensity.

Instrument panel flood lighting consists of four red flood lights on the underside of the glare shield, and two red flood lights in the forward part of the overhead console. The lights are utilized by adjusting light intensity with the large (outer) control knob of the concentric control knobs labeled POST, FLOOD. Flood lighting may be used in combination with post lighting by adjusting post light intensity with the small (inner) control knob.

The instrument panel may be equipped with post lights which are mounted at the edge of each instrument or control and provide direct lighting. To operate the post lights, adjust light intensity with the small

(inner) control knob of the concentric control knobs labeled POST, FLOOD. To combine post and flood lighting, adjust flood light intensity with the large (outer) control knob.

The engine instrument cluster, digital clock, radio equipment, and magnetic compass have integral lighting and operate independently of post or flood lighting. The light intensity of instrument cluster, digital clock, magnetic compass, and radio equipment lighting is controlled by the large (outer) control knob of the concentric control knobs labeled EL PANEL, ENG-RADIO. If the airplane is equipped with avionics incorporating incandescent digital readouts, the ENG-RADIO (large outer) control knob controls the light intensity of the digital readouts. For daylight operation, the control knob should be rotated full counterclockwise to produce maximum light intensity for the digital readouts only. Clockwise rotation of the control knob will provide normal variable light intensity for nighttime operation.

The control pedestal has two post lights and, if the airplane is equipped with oxygen, the overhead console is illuminated by post lights. Pedestal and console light intensity is controlled by the large (outer) control knob of the concentric control knobs labeled EL PANEL, ENG-RADIO.

Map lighting is provided by overhead console map lights and a glare shield mounted map light. The airplane may also be equipped with a control wheel map light. The overhead console map lights operate in conjunction with instrument panel flood lighting and consist of two openings just aft of the red instrument panel flood lights. The map light openings have sliding covers controlled by small round knobs which uncover the openings when moved toward each other. The covers should be kept closed unless the map lights are required. A map light and toggle switch, mounted in front of the pilot on the underside of the glare shield, is used for illuminating approach plates or other charts when using a control wheel mounted approach plate holder. The switch is labeled MAP LIGHT ON, OFF and light intensity is controlled by the FLOOD (large outer) control knob. A map light mounted on the bottom of the pilot's control wheel illuminates the lower portion of the cabin in front of the pilot, and is used for checking maps and other flight data during night operation. The light is utilized by turning on the NAV LIGHTS switch, and adjusting light intensity with the rheostat control knob on the bottom of the control wheel.

The airplane is equipped with a dome light aft of the overhead console, which is operated by a rocker-type switch, adjacent to the dome light.

The most probable cause of a light failure is a burned out bulb; however, in the event any of the lighting systems fail to illuminate when turned on, check the appropriate circuit breaker. If the circuit breaker has opened (white button popped out), and there is no obvious indication of a

short circuit (smoke or odor), turn off the light switch of the affected lights, reset the breaker, and turn the switch on again. If the breaker opens again, do not reset it.

CABIN HEATING, VENTILATING AND DEFROSTING SYSTEM

The temperature and volume of airflow into the cabin can be regulated by manipulation of the push-pull CABIN HEAT and CABIN AIR control knobs (see figure 7-8). When partial cabin heat is desired, blending warm and cold air will result in improved ventilation and heat distribution throughout the cabin. Additional outside air for summer ventilation is provided through the heat and vent system by operation of the push-pull AUX CABIN AIR knob. All three control knobs are the double button type with locks to permit intermediate settings.

Front cabin heat and ventilating air is supplied by outlet holes spaced across a cabin manifold just forward of the pilot's and copilot's feet. Rear cabin heat and air is supplied by three ducts from the manifold, one extending down each side of the cabin to an outlet at the front door post area at floor level and one extending under the center of the cabin floor to an outlet in the floor behind the pilot and copilot seats. The cabin floor outlet is flush mounted, with a removable airflow diverter.

Windshield defrost air is supplied by a duct from the cabin manifold to an outlet on top of the anti-glare shield; therefore, the temperature of the defrosting air is the same as heated cabin air. A rotary type control knob labeled DEFROST regulates the volume of air to the windshield. Clockwise rotation of the knob increases defroster air flow.

Additional cabin ventilation can be obtained from separate adjustable ventilators, one near each upper corner of the windshield for the pilot and copilot, and four adjustable ventilators in the cabin ceiling adjacent to the center and rear seat passengers.

PITOT-STATIC SYSTEM AND INSTRUMENTS

The pitot-static system supplies ram air pressure to the airspeed indicator and static pressure to the airspeed indicator, vertical speed indicator and altimeter. The system is composed of a pitot tube mounted on the lower surface of the left wing, two external static ports, one on each side of the lower forward portion of the fuselage, and the associated plumbing necessary to connect the instruments to the sources.

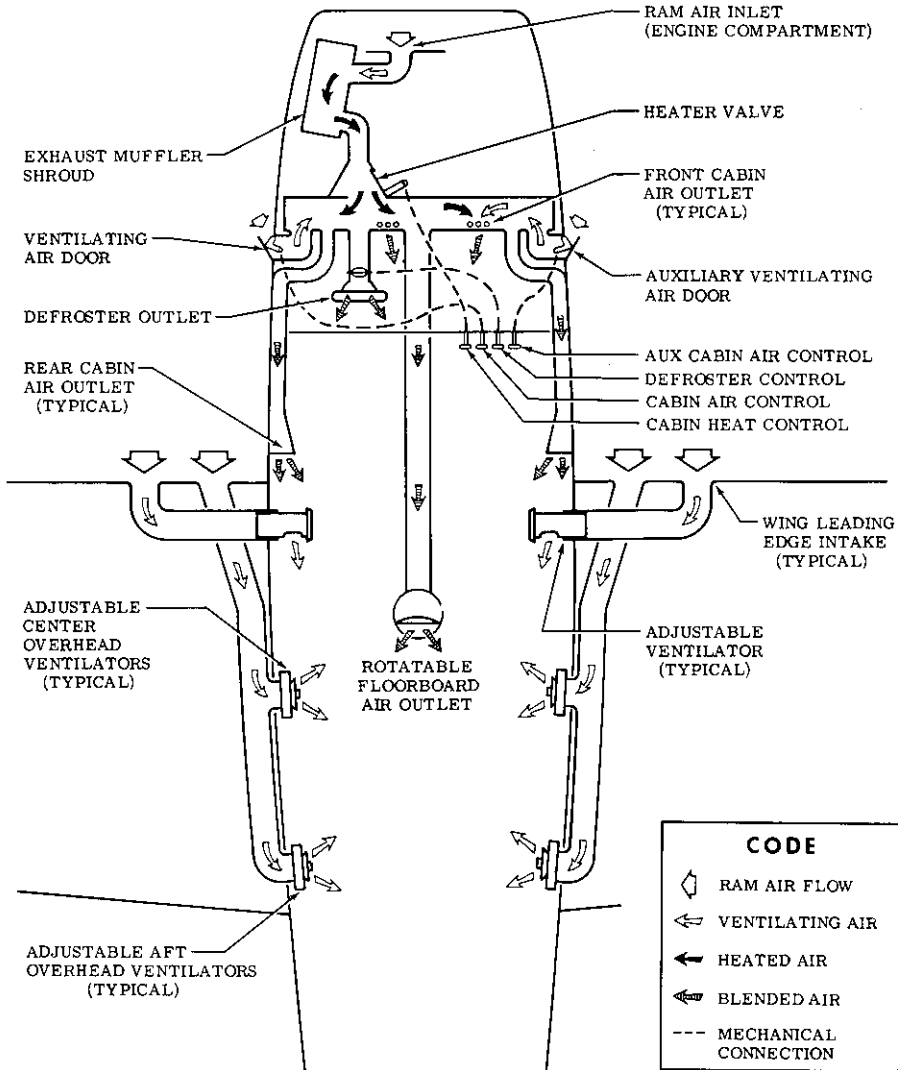

CODE	
	RAM AIR FLOW
	VENTILATING AIR
	HEATED AIR
	BLENDED AIR
	MECHANICAL CONNECTION

Figure 7-8. Cabin Heating, Ventilating, and Defrosting System

The airplane may also be equipped with a pitot heat system. The system consists of a heating element in the pitot tube, a rocker-type switch labeled PITOT HEAT on the lower left side of the instrument panel, a 10-amp circuit breaker on the lower left side of the instrument panel, and associated wiring. When the pitot heat switch is turned on, the element in the pitot tube is heated electrically to maintain proper operation in possible icing conditions. Pitot heat should be used only as required.

A static pressure alternate source valve may be installed to the right of the parking brake, and can be used if the external static source is malfunctioning. This valve supplies static pressure from inside the cabin instead of the external static ports.

If erroneous instrument readings are suspected due to water or ice in the pressure lines going to the standard external static pressure source, the alternate static source valve should be pulled on.

AIRSPPEED INDICATOR

The airspeed indicator is calibrated in knots and miles per hour. Limitation and range markings (in KIAS) include the white arc (46 to 100 knots), green arc (55 to 149 knots), yellow arc (149 to 183 knots), and a red line (183 knots).

If a true airspeed indicator is installed, it is equipped with a rotatable ring which works in conjunction with the airspeed indicator dial in a manner similar to the operation of a flight computer. To operate the indicator, first rotate the ring until pressure altitude is aligned with outside air temperature in degrees Fahrenheit. Pressure altitude should not be confused with indicated altitude. To obtain pressure altitude, momentarily set the barometric scale on the altimeter to 29.92 and read the pressure altitude on the altimeter. Be sure to return the altimeter barometric scale to the original barometric setting after pressure altitude has been obtained. Having set the ring to correct for altitude and temperature, read the airspeed shown on the rotatable ring by the indicator pointer. For best accuracy, the indicated airspeed should be corrected to calibrated airspeed by referring to the Airspeed Calibration chart in Section 5. Knowing the calibrated airspeed, read true airspeed on the ring opposite the calibrated airspeed.

VERTICAL SPEED INDICATOR

The vertical speed indicator depicts airplane rate of climb or descent in feet per minute. The pointer is actuated by atmospheric pressure changes resulting from changes of altitude as supplied by the static source.

ALTIMETER

Airplane altitude is depicted by a barometric type altimeter. A knob near the lower left portion of the indicator provides adjustment of the instrument's barometric scale to the current altimeter setting.

VACUUM SYSTEM AND INSTRUMENTS

An engine-driven vacuum system (see figure 7.9) is available and provides the suction necessary to operate the attitude indicator and directional indicator. The system consists of a vacuum pump on the engine, a vacuum relief valve and vacuum system air filter on the aft side of the firewall below the instrument panel, vacuum operated instruments on the left side of the instrument panel, and a suction gage on the right side of the panel.

ATTITUDE INDICATOR

An attitude indicator is available and gives a visual indication of flight attitude. Bank attitude is presented by a pointer at the top of the indicator relative to the bank scale which has index marks at 10°, 20°, 30°, 60°, and 90° either side of the center mark. Pitch and roll attitudes are presented by a miniature airplane superimposed over a symbolic horizon area divided into two sections by a white horizon bar. The upper "blue sky" area and the lower "ground" area have arbitrary pitch reference lines useful for pitch attitude control. A knob at the bottom of the instrument is provided for in-flight adjustment of the miniature airplane to the horizon bar for a more accurate flight attitude indication.

DIRECTIONAL INDICATOR

A directional indicator is available and displays airplane heading on a compass card in relation to a fixed simulated airplane image and index. The directional indicator will precess slightly over a period of time. Therefore, the compass card should be set in accordance with the magnetic compass just prior to takeoff, and occasionally re-adjusted on extended flights. A knob on the lower left edge of the instrument is used to adjust the compass card to correct for any precession.

SUCTION GAGE

The suction gage, located on the right side of the instrument panel when the airplane is equipped with a vacuum system, is calibrated in inches of mercury and indicates suction available for operation of the attitude and directional indicators. The desired suction range is 4.6 to 5.4

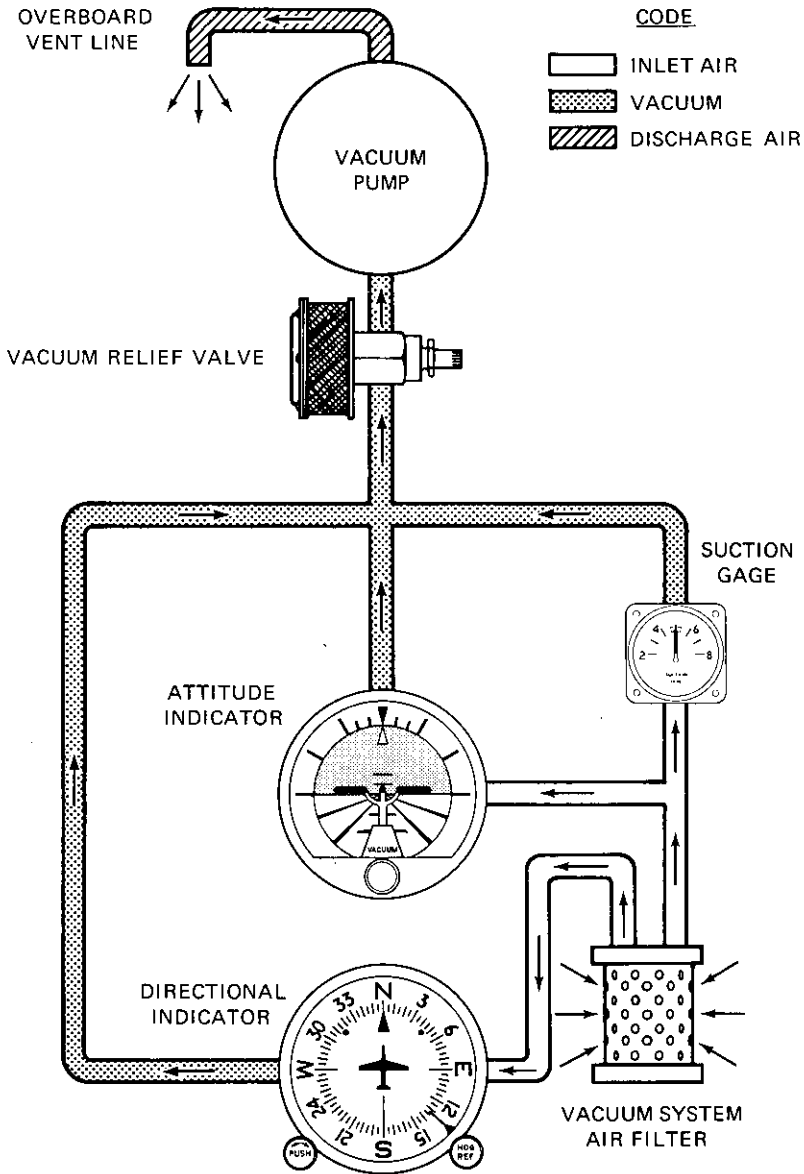

Figure 7-9. Vacuum System

inches of mercury. A suction reading below this range may indicate a system malfunction or improper adjustment, and in this case, the indicators should not be considered reliable.

STALL WARNING SYSTEM

The airplane is equipped with a vane-type stall warning unit, in the leading edge of the left wing, which is electrically connected to a stall warning horn behind the map compartment. A 5-amp circuit breaker protects the stall warning system. The vane in the wing senses the change in airflow over the wing, and operates the warning horn at airspeeds between 5 and 10 knots above the stall in all configurations.

If the airplane has a heated stall warning system, the vane and sensor unit in the wing leading edge is equipped with a heating element. The heated part of the system is operated by the PITOT HEAT switch, and is protected by the PITOT HEAT circuit breaker.

The stall warning system should be checked during the preflight inspection by momentarily turning on the master switch and actuating the vane in the wing. The system is operational if the warning horn sounds as the vane is pushed upward.

AVIONICS SUPPORT EQUIPMENT

If the airplane is equipped with avionics, various avionics support equipment may also be installed. Equipment available includes two types of audio control panels, microphone-headset installations and control surface static dischargers. The following paragraphs discuss these items. Description and operation of radio equipment is covered in Section 9 of this handbook.

AUDIO CONTROL PANEL

Two types of audio control panels (see figure 7-10) are available for this airplane, depending upon how many transmitters are included. The operational features of both audio control panels are similar and are discussed in the following paragraphs.

TRANSMITTER SELECTOR SWITCH

When the avionics package includes a maximum of two transmitters, a two-position toggle-type switch, labeled XMTR, is provided to switch the

microphone to the transmitter the pilot desires to use. If the airplane avionics package includes a third transmitter, the transmitter selector switch is a three-position rotary-type switch, labeled XMTR SEL. The numbers 1, 2, or 1, 2 and 3 adjacent to the selector switches correspond to the first, second and third (from top to bottom) transmitters in the avionics stack. To select a transmitter, place the transmitter selector switch in the position number corresponding to the desired transmitter.

The action of selecting a particular transmitter using the transmitter selector switch simultaneously selects the audio amplifier associated with that transmitter to provide speaker audio. For example, if the number one transmitter is selected, the audio amplifier in the number one NAV/COM is also selected and is used for ALL speaker audio. In the event the audio amplifier in use fails, as evidenced by loss of all speaker audio, selecting an alternate transmitter will reestablish speaker audio using the alternate transmitter audio amplifier. Headset audio is not affected by audio amplifier operation.

AUDIO SELECTOR SWITCHES

Both audio control panels (see figure 7-10) incorporate three-position toggle-type audio selector switches for individual control of the audio from systems installed in the airplane. These switches allow receiver audio to be directed to the airplane speaker or to a headset, and heard singly or in combination with other receivers. To hear a particular receiver on the airplane speaker, place that receiver's audio selector switch in the up (SPEAKER) position. To listen to a receiver over a headset, place that receiver's audio selector switch in the down (PHONE) position. The center (OFF) position turns off all audio from the associated receiver.

NOTE

Volume level is adjusted using the individual receiver volume controls on each radio.

A special feature of the audio control panel used when one or two transmitters are installed is separate control of NAV and COM audio from the NAV/COM radios. With this installation, the audio selector switches labeled NAV, 1 and 2 select audio from the navigation receivers of the NAV/COM radios only. Communication receiver audio is selected by the switches labeled COM, AUTO and BOTH. Description and operation of these switches is described in later paragraphs.

When the audio control panel for three transmitters is installed, audio from both NAV and COM frequencies is combined, and is selected by the audio selector switches labeled NAV/COM, 1, 2 and 3.

USED WITH ONE OR TWO TRANSMITTERS

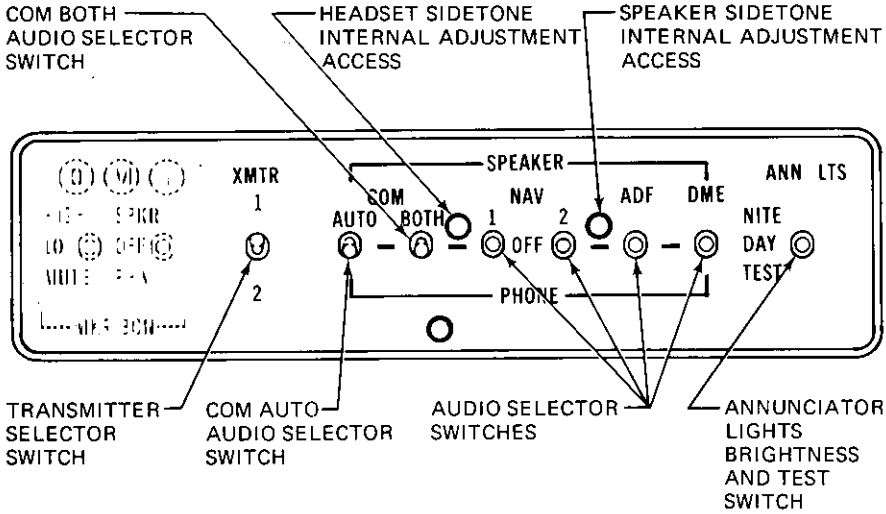

USED WITH THREE TRANSMITTERS

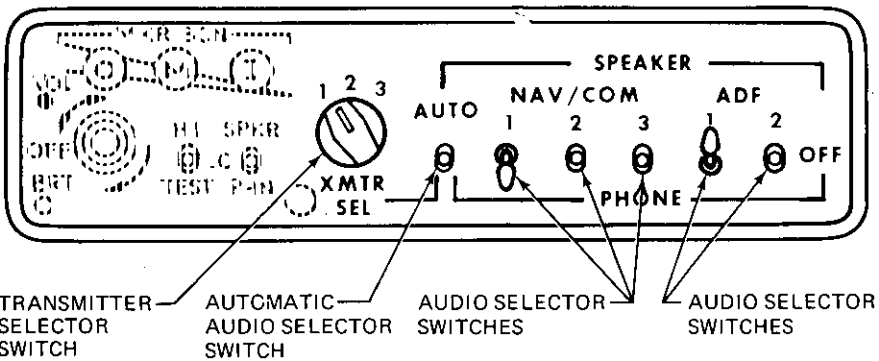

Figure 7-10. Audio Control Panel

COM AUTO AUDIO SELECTOR SWITCH

The audio control panel used with either one or two transmitters incorporates a three-position toggle switch, labeled COM AUTO, which is provided to automatically match the audio of the appropriate NAV/COM communications receiver to the transmitter selected by the transmitter selector switch. When the COM AUTO selector switch is placed in the up (SPEAKER) position, audio from the communications receiver selected by the transmitter selector switch will be heard on the airplane speaker. Switching the transmitter selector switch to the other transmitter automatically switches the other communications receiver audio to the speaker. This automatic audio switching feature may also be utilized when listening on a headset by placing the COM AUTO switch in the down (PHONE) position. If automatic audio selection is not desired, the COM AUTO selector switch should be placed in the center (OFF) position.

COM BOTH AUDIO SELECTOR SWITCH

The audio control panel used with either one or two transmitters incorporates a three-position toggle switch, labeled COM BOTH, which is provided to allow both COM receivers to be monitored at the same time. For example, if the COM AUTO switch is in the SPEAKER position, with the transmitter selector switch in the number one transmitter position, number one communications receiver audio will be heard on the airplane speaker. If it is also desired to monitor the number two communications receiver audio without changing the position of the transmitter selector switch, place the COM BOTH selector switch in the up (SPEAKER) position so that the number two communications receiver audio will be heard in addition to the number one communications receiver audio. This feature can also be used when listening on a headset by placing the COM BOTH audio selector switch in the down (PHONE) position.

NOTE

The combination of placing the COM AUTO switch in the SPEAKER position and the COM BOTH switch in the PHONE position (or vice versa) is not normally recommended as it will cause audio from both communications receivers (and any other navigation receiver with its audio selector switch in the PHONE position) to be heard on both the airplane speaker and the headset simultaneously.

AUTO AUDIO SELECTOR SWITCH

The audio control panel used with three transmitters incorporates a three-position toggle switch, labeled AUTO, which is provided to automatically match the audio of the appropriate NAV/COM receiver to the

selected transmitter. To utilize this automatic feature, leave all NAV/COM audio selector switches in the center (OFF) position, and place the AUTO selector switch in either the SPEAKER or PHONE position, as desired. Once the AUTO selector switch is positioned, the pilot may then select any transmitter and its associated NAV/COM receiver audio simultaneously with the transmitter selector switch. If automatic audio selection is not desired, the AUTO selector switch should be placed in the center (OFF) position.

NOTE

If the NAV/COM audio selector switch corresponding to the selected transmitter is in the PHONE position with the AUTO selector switch in the SPEAKER position, all audio selector switches placed in the PHONE position will automatically be connected to both the airplane speaker and any headsets in use.

ANNUNCIATOR LIGHTS BRIGHTNESS AND TEST SWITCH

The audio control panel used with either one or two transmitters incorporates a three-position toggle-type switch to control the brightness level of the marker beacon indicator lights (and certain other annunciator lights associated with avionics equipment). When the switch is placed in the center (DAY) position, the indicator lights will show full bright. When this switch is placed in the up (NITE) position, the lights are set to a reduced level for typical night operations and can be further adjusted using the RADIO LT dimming rheostat knob. The down (TEST) position illuminates all lamps (except the ARC light in the NAV indicators) which are controlled by the switch to the full bright level to verify lamp operation.

SIDETONE OPERATION

Cessna radios are equipped with sidetone capability (monitoring of the operator's own voice transmission). While adjusting sidetone, be aware that if the sidetone volume level is set too high, audio feedback (squeal) may result when transmitting.

When the airplane has one or two transmitters, sidetone is provided in both the speaker and headset anytime the COM AUTO selector switch is utilized. Placing the COM AUTO selector switch in the OFF position will eliminate sidetone. Sidetone internal adjustments are available to the pilot through the front of the audio control panel (see figure 7-10). Adjustment can be made by removing the appropriate plug-button from the audio control panel (left button for headset adjustment and right button for speaker adjustment), inserting a small screwdriver into the adjustment

potentiometer and rotating it clockwise to increase the sidetone volume level.

When the airplane has three transmitters, sidetone will be heard on either the speaker or a headset as selected with the AUTO selector switch. Sidetone may be eliminated by placing the AUTO selector switch in the OFF position, and utilizing the individual audio selector switches. Adjustment of speaker and headset sidetone volume can only be accomplished by adjusting the sidetone potentiometers located inside the audio control panel.

NOTE

Sidetone is not available on HF Transceivers (Types PT10-A and ASB-125), when installed.

MICROPHONE-HEADSET INSTALLATIONS

Three types of microphone-headset installations are offered. The standard system provided with avionics equipment includes a hand-held microphone and separate headset. The keying switch for this microphone is on the microphone. Two optional microphone headset installations are also available; these feature a single-unit microphone-headset combination which permits the pilot to conduct radio communications without interrupting other control operations to handle a hand-held microphone. One microphone-headset combination is offered without a padded headset and the other version has a padded headset. The microphone-headset combinations utilize a remote keying switch located on the left grip of the pilot's control wheel. The microphone and headset jacks are located on the left side of the instrument panel. Audio to all three headsets is controlled by the individual audio selector switches and adjusted for volume level by using the selected receiver volume controls.

NOTE

When transmitting, the pilot should key the microphone, place the microphone as close as possible to the lips, and speak directly into it.

STATIC DISCHARGERS

If frequent IFR flights are planned, installation of wick-type static dischargers is recommended to improve radio communications during

flight through dust or various forms of precipitation (rain, snow or ice crystals). Under these conditions, the build-up and discharge of static electricity from the trailing edges of the wings, rudder, elevator, propeller tips, and radio antennas can result in loss of usable radio signals on all communications and navigation radio equipment. Usually the ADF is first to be affected and VHF communication equipment is the last to be affected.

Installation of static dischargers reduces interference from precipitation static, but it is possible to encounter severe precipitation static conditions which might cause the loss of radio signals, even with static dischargers installed. Whenever possible, avoid known severe precipitation areas to prevent loss of dependable radio signals. If avoidance is impractical, minimize airspeed and anticipate temporary loss of radio signals while in these areas.

SECTION 8

AIRPLANE HANDLING, SERVICE & MAINTENANCE

TABLE OF CONTENTS

	Page
Introduction	8-3
Identification Plate	8-3
Owner Follow-Up System	8-3
Publications	8-3
Airplane File	8-4
Airplane Inspection Periods	8-5
FAA Required Inspections	8-5
Cessna Progressive Care	8-6
Cessna Customer Care Program	8-6
Pilot Conducted Preventive Maintenance	8-7
Alterations Or Repairs	8-7
Ground Handling	8-8
Towing	8-8
Parking	8-8
Tie-Down	8-8
Jacking	8-8
Leveling	8-9
Flyable Storage	8-9
Servicing	8-10
Engine Oil	8-10
Fuel	8-12
Landing Gear	8-14
Oxygen	8-15
Cleaning And Care	8-15
Windshield-Windows	8-15
Painted Surfaces	8-15
Propeller Care	8-16
Engine Care	8-16
Interior Care	8-17

INTRODUCTION

This section contains factory-recommended procedures for proper ground handling and routine care and servicing of your Cessna. It also identifies certain inspection and maintenance requirements which must be followed if your airplane is to retain that new-plane performance and dependability. It is wise to follow a planned schedule of lubrication and preventive maintenance based on climatic and flying conditions encountered in your locality.

Keep in touch with your Cessna Dealer and take advantage of his knowledge and experience. He knows your airplane and how to maintain it. He will remind you when lubrications and oil changes are necessary, and about other seasonal and periodic services.

IDENTIFICATION PLATE

All correspondence regarding your airplane should include the SERIAL NUMBER. The Serial Number, Model Number, Production Certificate Number (PC) and Type Certificate Number (TC) can be found on the Identification Plate, located on the left forward doorpost. Located adjacent to the Identification Plate is a Finish and Trim Plate which contains a code describing the interior color scheme and exterior paint combination of the airplane. The code may be used in conjunction with an applicable Parts Catalog if finish and trim information is needed.

OWNER FOLLOW-UP SYSTEM

Your Cessna Dealer has an Owner Follow-Up System to notify you when he receives information that applies to your Cessna. In addition, if you wish, you may choose to receive similar notification, in the form of Service Letters, directly from the Cessna Customer Services Department. A subscription form is supplied in your Customer Care Program book for your use, should you choose to request this service. Your Cessna Dealer will be glad to supply you with details concerning these follow-up programs, and stands ready, through his Service Department, to supply you with fast, efficient, low-cost service.

PUBLICATIONS

Various publications and flight operation aids are furnished in the

**SECTION 8
HANDLING, SERVICE
& MAINTENANCE**

**CESSNA
MODEL U206G**

airplane when delivered from the factory. These items are listed below.

- CUSTOMER CARE PROGRAM BOOK
- PILOT'S OPERATING HANDBOOK AND FAA APPROVED AIRPLANE FLIGHT MANUAL
- AVIONICS OPERATION GUIDE
- PILOT'S CHECKLISTS
- POWER COMPUTER
- CUSTOMER CARE DEALER DIRECTORY
- DO'S AND DON'TS ENGINE BOOKLET

The following additional publications, plus many other supplies that are applicable to your airplane, are available from your Cessna Dealer.

- INFORMATION MANUAL (Contains Pilot's Operating Handbook Information)
- SERVICE MANUALS AND PARTS CATALOGS FOR YOUR:
AIRPLANE
ENGINE AND ACCESSORIES
AVIONICS AND AUTOPILOT

Your Cessna Dealer has a Customer Care Supplies Catalog covering all available items, many of which he keeps on hand. He will be happy to place an order for any item which is not in stock.

NOTE

A Pilot's Operating Handbook and FAA Approved Airplane Flight Manual which is lost or destroyed may be replaced by contacting your Cessna Dealer or writing directly to the Customer Services Department, Cessna Aircraft Company, Wichita, Kansas. An affidavit containing the owner's name, airplane serial number and registration number must be included in replacement requests since the Pilot's Operating Handbook and FAA Approved Airplane Flight Manual is identified for specific airplanes only.

AIRPLANE FILE

There are miscellaneous data, information and licenses that are a part of the airplane file. The following is a checklist for that file. In addition, a

periodic check should be made of the latest Federal Aviation Regulations to ensure that all data requirements are met.

- A. To be displayed in the airplane at all times:
1. Aircraft Airworthiness Certificate (FAA Form 8100-2).
 2. Aircraft Registration Certificate (FAA Form 8050-3).
 3. Aircraft Radio Station License, if transmitter installed (FCC Form 556).
- B. To be carried in the airplane at all times:
1. Pilot's Operating Handbook and FAA Approved Airplane Flight Manual.
 2. Weight and Balance, and associated papers (latest copy of the Repair and Alteration Form, FAA Form 337, if applicable).
 3. Equipment List.
- C. To be made available upon request:
1. Airplane Log Book.
 2. Engine Log Book.

Most of the items listed are required by the United States Federal Aviation Regulations. Since the Regulations of other nations may require other documents and data, owners of airplanes not registered in the United States should check with their own aviation officials to determine their individual requirements.

Cessna recommends that these items, plus the Pilot's Checklists, Power Computer, Customer Care Program book and Customer Care Card, be carried in the airplane at all times.

AIRPLANE INSPECTION PERIODS

FAA REQUIRED INSPECTIONS

As required by Federal Aviation Regulations, all civil aircraft of U.S. registry must undergo a complete inspection (annual) each twelve calendar months. In addition to the required ANNUAL inspection, aircraft operated commercially (for hire) must have a complete inspection every 100 hours of operation.

The FAA may require other inspections by the issuance of airworthiness directives applicable to the airplane, engine, propeller and components. It is the responsibility of the owner/operator to ensure compliance with all applicable airworthiness directives and, when the inspections are

repetitive, to take appropriate steps to prevent inadvertent noncompliance.

In lieu of the 100 HOUR and ANNUAL inspection requirements, an airplane may be inspected in accordance with a progressive inspection schedule, which allows the work load to be divided into smaller operations that can be accomplished in shorter time periods.

The CESSNA PROGRESSIVE CARE PROGRAM has been developed to provide a modern progressive inspection schedule that satisfies the complete airplane inspection requirements of both the 100 HOUR and ANNUAL inspections as applicable to Cessna airplanes. The program assists the owner in his responsibility to comply with all FAA inspection requirements, while ensuring timely replacement of life-limited parts and adherence to factory-recommended inspection intervals and maintenance procedures.

CESSNA PROGRESSIVE CARE

The Cessna Progressive Care Program has been designed to help you realize maximum utilization of your airplane at a minimum cost and downtime. Under this program, your airplane is inspected and maintained in four operations at 50-hour intervals during a 200-hour period. The operations are recycled each 200 hours and are recorded in a specially provided Aircraft Inspection Log as each operation is conducted.

The Cessna Aircraft Company recommends Progressive Care for airplanes that are being flown 200 hours or more per year, and the 100-hour inspection for all other airplanes. The procedures for the Progressive Care Program and the 100-hour inspection have been carefully worked out by the factory and are followed by the Cessna Dealer Organization. The complete familiarity of Cessna Dealers with Cessna equipment and factory-approved procedures provides the highest level of service possible at lower cost to Cessna owners.

Regardless of the inspection method selected by the owner, he should keep in mind that FAR Part 43 and FAR Part 91 establishes the requirement that properly certified agencies or personnel accomplish all required FAA inspections and most of the manufacturer recommended inspections.

CESSNA CUSTOMER CARE PROGRAM

Specific benefits and provisions of the CESSNA WARRANTY plus other important benefits for you are contained in your CUSTOMER CARE PROGRAM book supplied with your airplane. You will want to thoroughly

review your Customer Care Program book and keep it in your airplane at all times.

Coupons attached to the Program book entitle you to an initial inspection and either a Progressive Care Operation No. 1 or the first 100-hour inspection within the first 6 months of ownership at no charge to you. If you take delivery from your Dealer, the initial inspection will have been performed before delivery of the airplane to you. If you pick up your airplane at the factory, plan to take it to your Dealer reasonably soon after you take delivery, so the initial inspection may be performed allowing the Dealer to make any minor adjustments which may be necessary.

You will also want to return to your Dealer either at 50 hours for your first Progressive Care Operation, or at 100 hours for your first 100-hour inspection depending on which program you choose to establish for your airplane. While these important inspections will be performed for you by any Cessna Dealer, in most cases you will prefer to have the Dealer from whom you purchased the airplane accomplish this work.

PILOT CONDUCTED PREVENTIVE MAINTENANCE

A certified pilot who owns or operates an airplane not used as an air carrier is authorized by FAR Part 43 to perform limited maintenance on his airplane. Refer to FAR Part 43 for a list of the specific maintenance operations which are allowed.

NOTE

Pilots operating airplanes of other than U.S. registry should refer to the regulations of the country of certification for information on preventive maintenance that may be performed by pilots.

A Service Manual should be obtained prior to performing any preventive maintenance to ensure that proper procedures are followed. Your Cessna Dealer should be contacted for further information or for required maintenance which must be accomplished by appropriately licensed personnel.

ALTERATIONS OR REPAIRS

It is essential that the FAA be contacted prior to any alterations on the airplane to ensure that airworthiness of the airplane is not violated.

Alterations or repairs to the airplane must be accomplished by licensed personnel.

GROUND HANDLING

TOWING

The airplane is most easily and safely maneuvered by hand with the tow-bar attached to the nose wheel. When towing with a vehicle, do not exceed the nose gear turning angle of 35° either side of center, or damage to the gear will result. If the airplane is towed or pushed over a rough surface during hangaring, watch that the normal cushioning action of the nose strut does not cause excessive vertical movement of the tail and the resulting contact with low hangar doors or structure. A flat nose tire or deflated strut will also increase tail height.

PARKING

When parking the airplane, head into the wind and set the parking brakes. Do not set the parking brakes during cold weather when accumulated moisture may freeze the brakes, or when the brakes are overheated. Close the cowl flaps, install the control wheel lock and chock the wheels. In severe weather and high wind conditions, tie the airplane down as outlined in the following paragraph.

TIE-DOWN

Proper tie-down procedure is the best precaution against damage to the parked airplane by gusty or strong winds. To tie-down the airplane securely, proceed as follows:

1. Set the parking brake and install the control wheel lock.
2. Install a surface control lock over the fin and rudder.
3. Tie sufficiently strong ropes or chains (700 pounds tensile strength) to the wing and tail tie-down fittings and secure each rope or chain to a ramp tie-down.
4. Tie a rope (no chains or cables) to the nose gear torque link and secure to a ramp tie-down.
5. Install a pitot tube cover.

JACKING

When a requirement exists to jack one or both main gear, the entire airplane should be jacked by using the wing jack points. Refer to the Service Manual for specific procedures and equipment required.

If nose gear maintenance is required, the nose wheel may be raised off the ground by pressing down on a tailcone bulkhead, just forward of the horizontal stabilizer, and allowing the tail to rest on the tail tie-down ring.

NOTE

Do not apply pressure on the elevator or outboard horizontal stabilizer surfaces. When pushing on the tailcone, always apply pressure at a bulkhead to avoid buckling the skin.

To assist in raising and holding the nose wheel off the ground, weight down the tail by placing sand-bags, or suitable weights, on each side of the horizontal stabilizer, next to the fuselage. If ground anchors are available, the tail should be securely tied down.

NOTE

Ensure that the nose will be held off the ground under all conditions by means of suitable stands or supports under weight supporting bulkheads near the nose of the airplane.

LEVELING

Longitudinal leveling of the airplane is accomplished by placing a level on the leveling screws located on the left side of the tailcone. Deflate the nose tire and/or lower or raise the nose strut to properly center the bubble in the level. Corresponding points on the front seat rails may be used to level the airplane laterally.

FLYABLE STORAGE

Airplanes placed in non-operational storage for a maximum of 30 days or those which receive only intermittent operational use for the first 25 hours are considered in flyable storage status. Every seventh day during these periods, the propeller should be rotated by hand through five revolutions. This action "limbers" the oil and prevents any accumulation of corrosion on engine cylinder walls.

WARNING

For maximum safety, check that the ignition switch is OFF, the throttle is closed, the mixture control is in the idle cut-off position, and the airplane is secured before rotating the propeller by hand. Do not stand within the arc of the

propeller blades while turning the propeller.

After 30 days, the airplane should be flown for 30 minutes or a ground runup should be made just long enough to produce an oil temperature within the lower green arc range. Excessive ground runup should be avoided.

Engine runup also helps to eliminate excessive accumulations of water in the fuel system and other air spaces in the engine. Keep fuel tanks full to minimize condensation in the tanks. Keep the battery fully charged to prevent the electrolyte from freezing in cold weather. If the airplane is to be stored temporarily, or indefinitely, refer to the Service Manual for proper storage procedures.

SERVICING

In addition to the PREFLIGHT INSPECTION covered in Section 4, COMPLETE servicing, inspection, and test requirements for your airplane are detailed in the Service Manual. The Service Manual outlines all items which require attention at 50, 100, and 200 hour intervals plus those items which require servicing, inspection, and/or testing at special intervals.

Since Cessna Dealers conduct all service, inspection, and test procedures in accordance with applicable Service Manuals, it is recommended that you contact your Cessna Dealer concerning these requirements and begin scheduling your airplane for service at the recommended intervals.

Cessna Progressive Care ensures that these requirements are accomplished at the required intervals to comply with the 100-hour or ANNUAL inspection as previously covered.

Depending on various flight operations, your local Government Aviation Agency may require additional service, inspections, or tests. For these regulatory requirements, owners should check with local aviation officials where the airplane is being operated.

For quick and ready reference, quantities, materials, and specifications for frequently used service items are as follows:

ENGINE OIL

GRADE AND VISCOSITY FOR TEMPERATURE RANGE --

All temperatures, use SAE 20W-50 or

Above 4°C (40°F), use SAE 50

Below 4°C (40°F), use SAE 30

Multi-viscosity oil with a range of SAE 20W-50 is recommended for improved starting in cold weather. Ashless dispersant oil, conforming to Continental Motors Specification MHS-24 (and all revisions thereto), must be used.

NOTE

Your Cessna was delivered from the factory with a corrosion preventive aircraft engine oil. If oil must be added during the first 25 hours, use only aviation grade straight mineral oil conforming to Specification No. MIL-L-6082.

CAPACITY OF ENGINE SUMP -- 12 Quarts.

Do not operate on less than 9 quarts. To minimize loss of oil through breather, fill to 10 quart level for normal flights of less than 3 hours. For extended flight, fill to 12 quarts. These quantities refer to oil dipstick level readings. During oil and oil filter changes, one additional quart is required when the filter is changed.

OIL AND OIL FILTER CHANGE --

After the first 25 hours of operation, drain engine oil sump and clean the oil pressure screen. If an oil filter is installed, change the filter at this time. Refill sump with straight mineral oil and use until a total of 50 hours has accumulated or oil consumption has stabilized; then change to dispersant oil. On airplanes not equipped with an oil filter, drain the engine oil sump and clean the oil pressure screen each 50 hours thereafter. On airplanes which have an oil filter, the oil change interval may be extended to 100-hour intervals, providing the oil filter is changed at 50-hour intervals. Change engine oil at least every 6 months even though less than the recommended hours have accumulated. Reduce intervals for prolonged operation in dusty areas, cold climates, or when short flights and long idle periods result in sludging conditions.

NOTE

During the first 25-hour oil and filter change, a general inspection of the overall engine compartment is required. Items which are not normally checked during a preflight inspection should be given special attention. Hoses, metal lines and fittings should be inspected for signs of oil and fuel leaks, and checked for abrasions, chafing, security, proper routing and support, and evidence of deterioration. Inspect the intake and exhaust systems for cracks, evidence of leakage, and security of attachment. Engine controls and linkages should be checked for freedom of

SECTION 8
HANDLING, SERVICE
& MAINTENANCE

CESSNA
MODEL U206G

movement through their full range, security of attachment and evidence of wear. Inspect wiring for security, chafing, burning, defective insulation, loose or broken terminals, heat deterioration, and corroded terminals. Check the alternator belt in accordance with Service Manual instructions, and retighten if necessary. A periodic check of these items during subsequent servicing operations is recommended.

FUEL

APPROVED FUEL GRADES (AND COLORS) --

100LL Grade Aviation Fuel (Blue).

100 (Formerly 100/130) Grade Aviation Fuel (Green).

NOTE

Isopropyl alcohol or ethylene glycol monomethyl ether may be added to the fuel supply in quantities not to exceed 1% or .15% by volume, respectively, of the total. Refer to Fuel Additives in later paragraphs for additional information.

CAPACITY EACH TANK -- 46.0 Gallons.

REDUCED CAPACITY EACH TANK (WHEN FILLED TO BOTTOM OF FUEL FILLER COLLAR) -- 34.5 Gallons.

NOTE

Service the fuel system after each flight, and keep fuel tanks full to minimize condensation in the tanks.

FUEL ADDITIVES --

Strict adherence to recommended preflight draining instructions as called for in Section 4 will eliminate any free water accumulations from the tank sumps. While small amounts of water may still remain in solution in the gasoline, it will normally be consumed and go unnoticed in the operation of the engine.

One exception to this can be encountered when operating under the combined effect of: (1) use of certain fuels, with (2) high humidity conditions on the ground (3) followed by flight at high altitude and low temperature. Under these unusual conditions, small amounts of water in solution can precipitate from the fuel stream and freeze in sufficient quantities to induce partial icing of the engine fuel system.

While these conditions are quite rare and will not normally pose a

problem to owners and operators, they do exist in certain areas of the world and consequently must be dealt with, when encountered.

Therefore, to alleviate the possibility of fuel icing occurring under these unusual conditions, it is permissible to add isopropyl alcohol or ethylene glycol monomethyl ether (EGME) compound to the fuel supply.

The introduction of alcohol or EGME compound into the fuel provides two distinct effects: (1) it absorbs the dissolved water from the gasoline and (2) alcohol has a freezing temperature depressant effect.

Alcohol, if used, is to be blended with the fuel in a concentration of 1% by volume. Concentrations greater than 1% are not recommended since they can be detrimental to fuel tank materials.

The manner in which the alcohol is added to the fuel is significant because alcohol is most effective when it is completely dissolved in the fuel. To ensure proper mixing, the following is recommended:

1. For best results, the alcohol should be added during the fueling operation by pouring the alcohol directly on the fuel stream issuing from the fueling nozzle.
2. An alternate method that may be used is to premix the complete alcohol dosage with some fuel in a separate clean container (approximately 2-3 gallon capacity) and then transferring this mixture to the tank prior to the fuel operation.

Any high quality isopropyl alcohol may be used, such as Anti-Icing Fluid (MIL-F-5566) or Isopropyl Alcohol (Federal Specification TT-I-735a). Figure 8-1 provides alcohol-fuel mixing ratio information.

Ethylene glycol monomethyl ether (EGME) compound, in compliance with MIL-I-27686 or Phillips PFA-55MB, if used, must be carefully mixed with the fuel in concentrations not to exceed .15% by volume. Figure 8-1 provides EGME-fuel mixing ratio information.

CAUTION

Mixing of the EGME compound with the fuel is extremely important because a concentration in excess of that recommended (.15% by volume maximum) will result in detrimental effects to the fuel tanks, such as deterioration of protective primer and sealants and damage to O-rings and seals in the fuel system and engine components. Use only

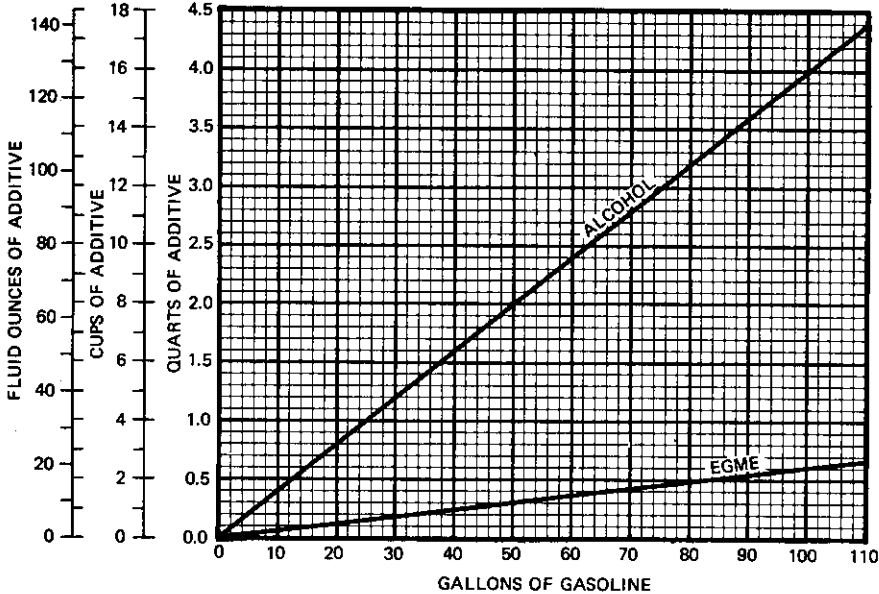

Figure 8-1. Additive Mixing Ratio

blending equipment that is recommended by the manufacturer to obtain proper proportioning.

CAUTION

Do not allow the concentrated EGME compound to come in contact with the airplane finish or fuel cell as damage can result.

Prolonged storage of the airplane will result in a water buildup in the fuel which "leeches out" the additive. An indication of this is when an excessive amount of water accumulates in the fuel tank sumps. The concentration can be checked using a differential refractometer. It is imperative that the technical manual for the differential refractometer be followed explicitly when checking the additive concentration.

LANDING GEAR

NOSE WHEEL TIRE PRESSURE -- 49 PSI on 5.00-5, 6-Ply Rated Tire.
29 PSI on 6.00-6, 4-Ply Rated Tire.

MAIN WHEEL TIRE PRESSURE -- 42 PSI on 6.00-6, 6-Ply Rated Tires.
35 PSI on 8.00-6, 6-Ply Rated Tires.

NOSE GEAR SHOCK STRUT --

Keep filled with MIL-H-5606 hydraulic fluid and inflated with air to 80 PSI. Do not over-inflate.

OXYGEN

AVIATOR'S BREATHING OXYGEN -- Spec. No. MIL-O-27210.

MAXIMUM PRESSURE (cylinder temperature stabilized after filling) --
1800 PSI at 21°C (70°F).

Refer to Oxygen Supplement (Section 9) for filling pressures.

CLEANING AND CARE

WINDSHIELD-WINDOWS

The plastic windshield and windows should be cleaned with an aircraft windshield cleaner. Apply the cleaner sparingly with soft cloths, and rub with moderate pressure until all dirt, oil scum and bug stains are removed. Allow the cleaner to dry, then wipe it off with soft flannel cloths.

If a windshield cleaner is not available, the plastic can be cleaned with soft cloths moistened with Stoddard solvent to remove oil and grease.

NOTE

Never use gasoline, benzine, alcohol, acetone, fire extinguisher or anti-ice fluid, lacquer thinner or glass cleaner to clean the plastic. These materials will attack the plastic and may cause it to craze.

Follow by **carefully** washing with a mild detergent and plenty of water. Rinse thoroughly, then dry with a clean moist chamois. **Do not rub** the plastic with a dry cloth since this builds up an electrostatic charge which attracts dust. Waxing with a good commercial wax will finish the cleaning job. A thin, even coat of wax, polished out by hand with clean soft flannel cloths, will fill in minor scratches and help prevent further scratching.

Do not use a canvas cover on the windshield unless freezing rain or sleet is anticipated since the cover may scratch the plastic surface.

PAINTED SURFACES

The painted exterior surfaces of your new Cessna have a durable, long

lasting finish and, under normal conditions, require no polishing or buffing. Approximately 10 days are required for the paint to cure completely; in most cases, the curing period will have been completed prior to delivery of the airplane. In the event that polishing or buffing is required within the curing period, it is recommended that the work be done by someone experienced in handling uncured paint. Any Cessna Dealer can accomplish this work.

Generally, the painted surfaces can be kept bright by washing with water and mild soap, followed by a rinse with water and drying with cloths or a chamois. Harsh or abrasive soaps or detergents which cause corrosion or scratches should never be used. Remove stubborn oil and grease with a cloth moistened with Stoddard solvent.

Waxing is unnecessary to keep the painted surfaces bright. However, if desired, the airplane may be waxed with a good automotive wax. A heavier coating of wax on the leading edges of the wings and tail and on the engine nose cap and propeller spinner will help reduce the abrasion encountered in these areas.

When the airplane is parked outside in cold climates and it is necessary to remove ice before flight, care should be taken to protect the painted surfaces during ice removal with chemical liquids. Isopropyl alcohol will satisfactorily remove ice accumulations without damaging the paint. While applying the de-icing solution, keep it away from the windshield and cabin windows since the alcohol will attack the plastic and may cause it to craze.

PROPELLER CARE

Preflight inspection of propeller blades for nicks, and wiping them occasionally with an oily cloth to clean off grass and bug stains will assure long, trouble-free service. Small nicks on the propeller, particularly near the tips and on the leading edges, should be dressed out as soon as possible since these nicks produce stress concentrations, and if ignored, may result in cracks. Never use an alkaline cleaner on the blades; remove grease and dirt with Stoddard solvent.

ENGINE CARE

The engine may be cleaned with Stoddard solvent, or equivalent, then dried thoroughly.

CAUTION

Particular care should be given to electrical equipment before cleaning. Cleaning fluids should not be allowed to

enter magnetos, starter, alternator and the like. Protect these components before saturating the engine with solvents. All other openings should also be covered before cleaning the engine assembly. Caustic cleaning solutions should be used cautiously and should always be properly neutralized after their use.

INTERIOR CARE

To remove dust and loose dirt from the upholstery and carpet, clean the interior regularly with a vacuum cleaner.

Blot up any spilled liquid promptly with cleansing tissue or rags. Don't pat the spot; press the blotting material firmly and hold it for several seconds. Continue blotting until no more liquid is taken up. Scrape off sticky materials with a dull knife, then spot-clean the area.

Oily spots may be cleaned with household spot removers, used sparingly. Before using any solvent, read the instructions on the container and test it on an obscure place on the fabric to be cleaned. Never saturate the fabric with a volatile solvent; it may damage the padding and backing materials.

Soiled upholstery and carpet may be cleaned with foam-type detergent, used according to the manufacturer's instructions. To minimize wetting the fabric, keep the foam as dry as possible and remove it with a vacuum cleaner.

If your airplane is equipped with leather seating, cleaning of the seats is accomplished using a soft cloth or sponge dipped in mild soap suds. The soap suds, used sparingly, will remove traces of dirt and grease. The soap should be removed with a clean damp cloth.

The plastic trim, headliner, instrument panel and control knobs need only be wiped off with a damp cloth. Oil and grease on the control wheel and control knobs can be removed with a cloth moistened with Stoddard solvent. Volatile solvents, such as mentioned in paragraphs on care of the windshield, must never be used since they soften and craze the plastic.

On airplanes equipped with a cargo interior, materials used on the cabin floor and sidewalls are not easily soiled or stained. Dust and loose dirt should be picked up with a vacuum cleaner. Stubborn dirt can be wiped off with a cloth moistened in clean water. Mild soap suds, used sparingly, will remove grease. The soap should be removed with a clean damp cloth.

SECTION 9 SUPPLEMENTS

(Optional Systems Description & Operating Procedures)

TABLE OF CONTENTS

Introduction

Supplements (Major Configuration Variations):

- 1. Floatplane

Supplements (General):

- 2. Ambulance Kit
 - 3. Camera Provisions Installation
 - 4. Cargo Pack
 - 5. Club Seating And Sidewall Table
 - 6. Convenience Table
 - 7. Digital Clock
 - 8. Electric Elevator Trim System (2 p
 - 9. Ground Service Plug Receptacle (4 pa
 - 10. Oxygen System (6 pa
 - 11. Propeller Anti-Ice System (2 pa
 - 12. Skydiving Kit (2 p
 - 13. Strobe Light System (2 p
 - 14. Windshield Anti-Ice System (2 p
 - 15. Winterization Kit (2 p
- #### Supplements (Avionics):
- 16. AM/FM Cassette Stereo Entertainment Center (8
(Type EC-100)
 - 17. DME (Type 190) (4
 - 18. Emergency Locator Transmitter (ELT) (4
 - 19. Foster Area Navigation System (Type 511) (8
 - 20. HF Transceiver (Type PT10-A) (
 - 21. SSB HF Transceiver (Type ASB-125) (
 - 22. Unslaved Horizontal Situation Indicator (Type IG-832C)
 - 23. 200A Navomatic Autopilot (Type AF-295B)
 - 24. 300 ADF (Type R-546E)
 - 25. 300 Nav/Com (Type RT-385A)
 - 26. 300 Nav/Com (Type RT-385A) With 400 Area

TABLE OF CONTENTS (Continued)

	Navigation System (Type RN-478A)	(8 pages)
27	300 Transponder (Type RT-359A) And Optional Altitude Encoder (Blind) With Optional IDENT Switch	(6 pages)
	300 Transponder (Type RT-359A) And Optional Encoding Altimeter (Type EA-401A) With Optional IDENT Switch	(6 pages)
	400A Navomatic Autopilot (Type AF-395A)	(6 pages)
	400 ADF (Type R-446A)	(6 pages)
	400 Area Navigation System (Type RN-478A)	(6 pages)
	400 DME (Type R-476A)	(4 pages)
	Glide Slope (Type R-443B)	(4 pages)
	Marker Beacon (Type R-402A)	(6 pages)
	Navomatic Autopilot (Type AF-420A)	(8 pages)
	Nav/Com (Type RT-485A)	(10 pages)
	Nav/Com (Type RT-485A) With 400 Area Navigation System (Type RN-478A)	(10 pages)
	Transponder (Type RT-459A) And Optional Altitude Encoder (Blind) With Optional IDENT Switch	(6 pages)
	Transponder (Type RT-459A) And Optional Encoding Altimeter (Type EA-401A) With Optional IDENT Switch	(6 pages)

INTRODUCTION

This section consists of a series of supplements, each covering a single optional system which may be installed in the airplane. Each supplement contains a brief description, and when applicable, operating limitations, emergency and normal procedures, and performance. As listed in the Table of Contents, the supplements are classified under the headings of major configuration variations, general and avionics and have been provided with reference numbers. Also, the supplements are arranged alphabetically and numerically to make it easier to locate a particular supplement. Other routinely installed items of optional equipment, whose function and operational procedures do not require detailed instructions, are discussed in Section 7.

Limitations contained in the following supplements are FAA approved. Observance of these operating limitations is required by Federal Aviation Regulations.

SUPPLEMENT

FLOATPLANE

SECTION 1

GENERAL

INTRODUCTION

This supplement, written especially for operators of the Cessna Stationair 6 floatplane, provides information not found in the basic handbook. It contains procedures and data required for safe and efficient operation of the airplane equipped with Edo Model 582-3430 floats.

Information contained in the basic handbook for the Stationair 6, which is the same as that for the floatplane, is generally not repeated in this supplement.

PERFORMANCE - SPECIFICATIONS

SPEED:	
Maximum at Sea Level	138 KNOTS
Cruise, 75% Power at 6500 Ft	132 KNOTS
CRUISE: Recommended lean mixture with fuel allowance for engine start, taxi, takeoff, climb and 45 minutes reserve.	
75% Power at 6500 Ft	Range 615 NM
88 Gallons Usable Fuel	Time 4.7 HRS
Maximum Range at 10,000 Ft	Range 770 NM
88 Gallons Usable Fuel	Time 7.7 HRS
RATE OF CLIMB AT SEA LEVEL	925 FPM
SERVICE CEILING	13,900 FT
TAKEOFF PERFORMANCE:	
Water Run	1835 FT
Total Distance Over 50-Ft Obstacle	2820 FT
LANDING PERFORMANCE:	
Water Run	780 FT
Total Distance Over 50-Ft Obstacle	1675 FT
STALL SPEED (CAS):	
Flaps Up, Power Off	56 KNOTS
Flaps Down, Power Off	51 KNOTS
MAXIMUM WEIGHT:	
Ramp (Dock)	3512 LBS
Takeoff or Landing	3500 LBS
STANDARD EMPTY WEIGHT:	
Stationair 6	2264 LBS
Stationair 6 II	2325 LBS
Utility Stationair 6	2240 LBS
Utility Stationair 6 II	2299 LBS
MAXIMUM USEFUL LOAD:	
Stationair 6	1248 LBS
Stationair 6 II	1187 LBS
Utility Stationair 6	1272 LBS
Utility Stationair 6 II	1213 LBS
BAGGAGE ALLOWANCE	180 LBS
WING LOADING: Pounds/Sq Ft	20.1
POWER LOADING: Pounds/HP	11.7
FUEL CAPACITY: Total	92 GAL.
OIL CAPACITY	12 QTS
ENGINE: Teledyne Continental, Fuel Injection	IO-520-F
300 BHP at 2850 RPM (5-Minute Takeoff Rating)	
285 BHP at 2700 RPM (Maximum Continuous Rating)	
PROPELLER: 3-Bladed Constant Speed, Diameter	80 IN.

DESCRIPTIVE DATA

MAXIMUM CERTIFICATED WEIGHTS

Ramp (Dock): 3512 lbs.

Takeoff: 3500 lbs.

Landing: 3500 lbs.

Weight in Baggage Compartment-Station 109 to 145: 180 lbs.

STANDARD AIRPLANE WEIGHTS

Standard Empty Weight, Stationair 6: 2264 lbs.

Stationair 6 II: 2325 lbs.

Utility Stationair 6: 2240 lbs.

Utility Stationair 6 II: 2299 lbs.

Maximum Useful Load, Stationair 6: 1248 lbs.

Stationair 6 II: 1187 lbs.

Utility Stationair 6: 1272 lbs.

Utility Stationair 6 II: 1213 lbs.

SPECIFIC LOADINGS

Wing Loading: 20.1 lbs./sq. ft.

Power Loading: 11.7 lbs./hp.

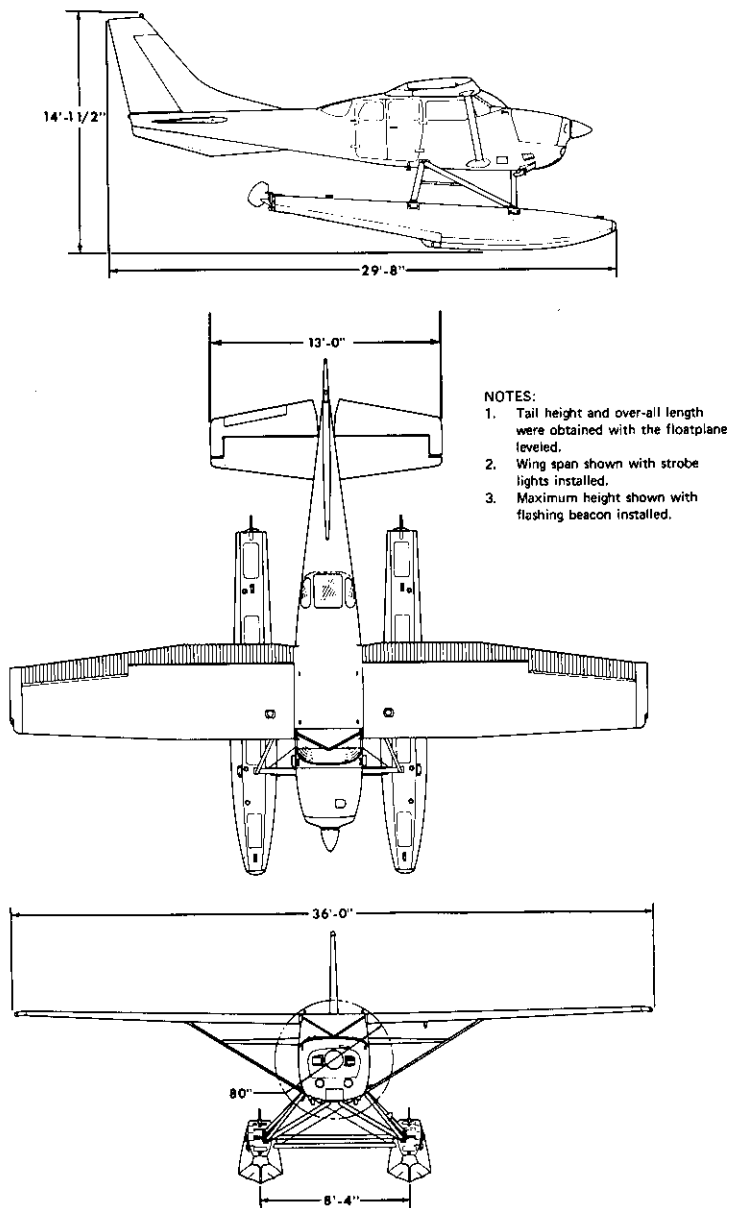

Figure 1. Three View

SECTION 2 LIMITATIONS

INTRODUCTION

Except as shown in this section, the floatplane operating limitations are the same as those for the Stationair 6 landplane. The limitations in this section apply only to operations of the Model U206G equipped with Edo Model 582-3430 floats. The limitations included in this section have been approved by the Federal Aviation Administration. Observance of these operating limitations is required by Federal Aviation Regulations.

AIRSPEED LIMITATIONS

Airspeed limitations and their operational significance are shown in figure 2.

	SPEED	KCAS	KIAS	REMARKS
V_{NE}	Never Exceed Speed	182	183	Do not exceed this speed in any operation.
V_{NO}	Maximum Structural Cruising Speed	148	149	Do not exceed this speed except in smooth air, and then only with caution.
V_A	Maneuvering Speed: 3500 Pounds 3000 Pounds 2500 Pounds	120 111 101	120 111 100	Do not make full or abrupt control movements above this speed.
V_{FE}	Maximum Flap Extended Speed: To 10° Flaps 10° - 30° Flaps	141 102	140 100	Do not exceed these speeds with the given flap settings.

Figure 2. Airspeed Limitations

AIRSPPEED INDICATOR MARKINGS

Airspeed indicator markings are the same as those shown in the basic handbook. Due to differences in airspeed system calibration and stall speeds with floats installed, the indicated stall speeds as shown in Section 5 of this supplement are slightly lower than reflected by the airspeed indicator markings.

WEIGHT LIMITS

Maximum Ramp (Dock) Weight: 3512 lbs.

Maximum Takeoff Weight: 3500 lbs.

Maximum Landing Weight: 3500 lbs.

Maximum Weight in Baggage Compartment - Station 109 to 145: 180 lbs.

NOTE

When floats are installed, it is possible to exceed the maximum takeoff weight with all seats occupied and minimum fuel.

CENTER OF GRAVITY LIMITS

Center of Gravity Range:

Forward: 34 inches aft of datum at 2600 lbs. or less, with straight line variation to 38.5 inches aft of datum at 3500 lbs.

Aft: 47.4 inches aft of datum at all weights.

Reference Datum: Lower portion of front face of firewall.

MANEUVER LIMITS

The maneuver limits defined in the basic handbook are applicable to the floatplane.

OTHER LIMITATIONS

FLAP LIMITATIONS

Approved Takeoff Range: 0° to 20°.

Approved Landing Range: 0° to 30°.

PLACARDS

The following information must be displayed in the form of composite or individual placards in addition to those specified in the basic handbook.

1. Near water rudder control:

WATER RUDDER ALWAYS UP
EXCEPT WATER TAXIING

2. Under wing flap switch and position indicator:

FLOATPLANE MAX FLAPS 30°

3. Near airspeed indicator:

FLOATPLANE
STALL SPEEDS ARE APPROX.
4 KIAS LOWER THAN
INDICATOR MARKINGS.

4. Near pilot's control column:

AVOID TAIL-LOW TAKEOFFS AND LANDINGS WITH
FLOATPLANE STINGER INSTALLED DURING OPER-
ATIONS AS A LANDPLANE.

SECTION 3 EMERGENCY PROCEDURES

INTRODUCTION

Checklist and amplified procedures contained in the basic handbook generally should be followed. The additional or changed procedures specifically required for operation of the Model U206G equipped with Edo Model 582-3430 floats are presented in this section.

AIRSPEEDS FOR EMERGENCY OPERATION

The speeds listed below should be substituted, as appropriate, for the speeds contained in Section 3 of the basic handbook.

Engine Failure After Takeoff:

Wing Flaps Up	80 KIAS
Wing Flaps Down 20°	70 KIAS

Maneuvering Speed:

3500 Lbs	120 KIAS
3000 Lbs	111 KIAS
2500 Lbs	100 KIAS

Maximum Glide:

3500 Lbs	75 KIAS
3000 Lbs	69 KIAS
2500 Lbs	63 KIAS

Precautionary Landing With Engine Power, Flaps Down

75 KIAS

Landing Without Engine Power:

Wing Flaps Up	80 KIAS
Wing Flaps Down	75 KIAS

OPERATIONAL CHECKLISTS

ENGINE FAILURE

ENGINE FAILURE DURING TAKEOFF RUN

1. Throttle -- IDLE.
2. Control Wheel -- FULL AFT.
3. Mixture -- IDLE CUT-OFF.
4. Ignition Switch -- OFF.
5. Master Switch -- OFF.

FORCED LANDINGS

EMERGENCY LANDING ON WATER WITHOUT ENGINE POWER

1. Airspeed -- 80 KIAS (flaps UP).
75 KIAS (flaps DOWN).
2. Mixture -- IDLE CUT-OFF.
3. Fuel Selector Valve -- OFF.
4. Ignition Switch -- OFF.
5. Wing Flaps -- AS REQUIRED.
6. Master Switch -- OFF.
7. Water Rudders -- UP.
8. Doors -- UNLATCH PRIOR TO APPROACH.
9. Touchdown -- SLIGHTLY TAIL LOW.
10. Control Wheel -- HOLD FULL AFT as floatplane decelerates.

EMERGENCY LANDING ON LAND WITHOUT ENGINE POWER

1. Airspeed -- 80 KIAS (flaps UP).
75 KIAS (flaps DOWN).
2. Mixture -- IDLE CUT-OFF.
3. Fuel Selector Valve -- OFF.
4. Ignition Switch -- OFF.
5. Wing Flaps -- AS REQUIRED (30° recommended).
6. Master Switch -- OFF.
7. Water Rudders -- UP.
8. Doors -- UNLATCH PRIOR TO APPROACH.
9. Touchdown -- LEVEL ATTITUDE.
10. Control Wheel -- FULL AFT (after contact).

AMPLIFIED PROCEDURES

MAXIMUM GLIDE

After an engine failure in flight, the best glide speed as shown in figure 3 should be established as quickly as possible.

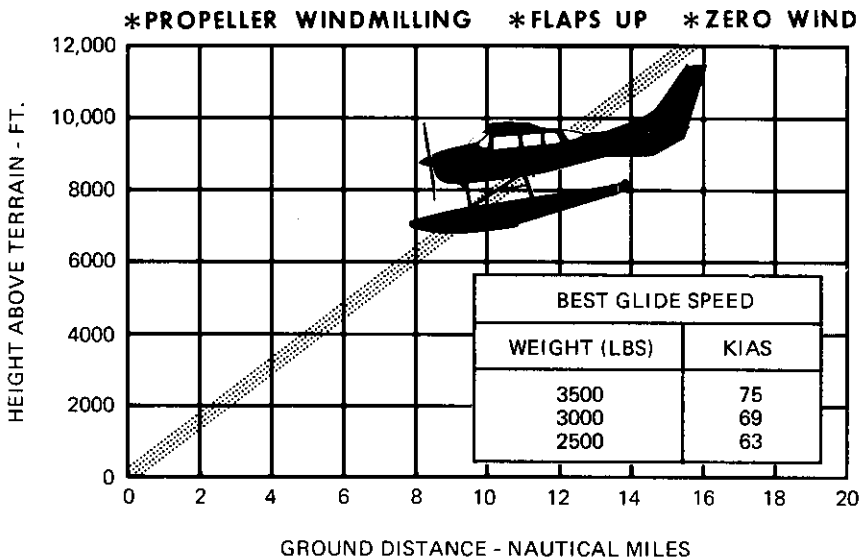

Figure 3. Maximum Glide

SECTION 4 NORMAL PROCEDURES

INTRODUCTION

Checklist and amplified procedures contained in the basic handbook generally should be followed. The additional or changed procedures specifically required for operation of the Model U206G equipped with Edo Model 582-3430 floats are presented in this section.

SPEEDS FOR NORMAL OPERATION

Unless otherwise noted, the following speeds are based on a maximum weight of 3500 pounds and may be used for any lesser weight. However, to achieve the performance specified in Section 5 of this supplement for takeoff distance and climb performance, the speed appropriate to the particular weight must be used.

Takeoff:

- Normal Climb Out 75-85 KIAS
- Maximum Performance, Flaps 20°, Speed at 50 Feet . . . 65 KIAS

Enroute Climb, Flaps Up:

- Normal 90-100 KIAS
- Best Rate of Climb, Sea Level 84 KIAS
- Best Rate of Climb, 10,000 Feet 77 KIAS
- Best Angle of Climb, Sea Level 63 KIAS
- Best Angle of Climb, 10,000 Feet 71 KIAS

Landing Approach:

- Normal Approach, Flaps Up 80-90 KIAS
- Normal Approach, Flaps 30° 70-80 KIAS
- Maximum Performance Approach, Flaps 30° 70 KIAS

Balked Landing:

- Maximum Power, Flaps 20° 65 KIAS

Maximum Recommended Turbulent Air Penetration Speed:

- 3500 Lbs 120 KIAS
- 3000 Lbs 111 KIAS
- 2500 Lbs 100 KIAS

Maximum Demonstrated Crosswind Velocity:

- Takeoff or Landing 12 KNOTS

CHECKLIST PROCEDURES

PREFLIGHT INSPECTION

1. Pilot's Operating Handbook and Floatplane Supplement -- AVAILABLE IN THE AIRPLANE.
2. Floats and Struts -- INSPECT for dents, cracks, scratches, etc.
3. Float Compartments -- INSPECT for water accumulation.

NOTE

Remove rubber balls which serve as stoppers on the standpipe in each float compartment and pump out any accumulation of water. Reinstall rubber balls with enough pressure for a snug fit.

4. Water Rudders -- CHECK freedom of movement and security.

BEFORE STARTING ENGINE

1. Water Rudder Operation -- CHECK VISUALLY.
2. Water Rudders -- DOWN for taxiing (retraction handle removed from stowage hook.)

TAKEOFF

1. Water Rudders -- UP (retraction handle secured on stowage hook).
2. Wing Flaps -- 20°.
3. Control Wheel -- HOLD FULL AFT.
4. Power -- FULL THROTTLE and 2850 RPM (advance slowly).
5. Mixture -- LEAN FOR LAKE ELEVATION ACCORDING TO PLACARD.
6. Control Wheel -- MOVE FORWARD when the nose stops rising to attain planing attitude (on the step).
7. Airspeed -- 50-60 KIAS.
8. Control Wheel -- APPLY LIGHT BACK PRESSURE to lift off.

NOTE

To reduce takeoff water run, the technique of raising one float out of the water may be used. This procedure is

described in the amplified procedures in this section.

9. Climb Speed -- 75-85 KIAS. With obstacles ahead, climb at 65 KIAS.
10. Wing Flaps -- UP after all obstacles are cleared.

ENROUTE CLIMB

NORMAL CLIMB

1. Airspeed -- 90-100 KIAS.

MAXIMUM PERFORMANCE CLIMB

1. Airspeed -- 84 KIAS (sea level) to 77 KIAS (10,000 feet).

BEFORE LANDING

1. Water Rudders -- UP.
2. Wing Flaps -- AS DESIRED.
3. Airspeed -- 80-90 KIAS (flaps UP).
70-80 KIAS (flaps DOWN).

LANDING

1. Touchdown -- SLIGHTLY TAIL LOW.
2. Control Wheel -- HOLD FULL AFT as floatplane decelerates to taxi speed.

NOTE

With forward loadings, a slight nose-down pitch may occur if the elevator is not held full up as the floatplane comes down off the step.

AFTER LANDING

1. Water Rudders -- DOWN.

AMPLIFIED PROCEDURES

TAXIING

Taxi with water rudders down. It is best to limit the engine speed to 800 RPM for normal taxi because water piles up in front of the float bow at higher engine speeds. Taxiing with higher engine RPM may result in engine overheating and will not appreciably increase the taxi speed. In addition, it may lead to water spray striking the propeller tips, causing propeller tip erosion.

During all low speed taxi operations, the elevator should be positioned to keep the float bows out of the water as far as possible. Normally, this requires holding the elevator control full aft.

For minimum taxi speed in close quarters, use idle RPM and a single magneto. This procedure is recommended for short periods of time only.

Although taxiing is very simple with the water rudders, it is sometimes necessary to "sail" the floatplane under high wind conditions. In addition to the normal flight controls, the wing flaps and cabin door will aid in "sailing". Water rudders should be retracted during "sailing".

Rudder trim may be used to reduce rudder pedal forces while taxiing in crosswinds or for extended sailing in one direction.

To taxi great distances, it may be advisable to taxi on the step with the water rudders retracted. Turns on the step from an upwind heading may be made with safety providing they are not too sharp and if ailerons are used to counteract any overturning tendency.

TAKEOFF

Start the takeoff by applying full throttle smoothly while holding the control wheel full aft. When the nose stops rising, move the control wheel forward slowly to place the floatplane on the step. Slow control movement and light control pressures produce the best results. Attempts to force the floatplane into the planing attitude will generally result in loss of speed and delay in getting on the step. The floatplane will assume a planing attitude which permits acceleration to takeoff speed (50-60 KIAS) at which time the floatplane will fly off smoothly.

The use of 20° wing flaps throughout the takeoff run is recommended. Upon reaching a safe altitude and airspeed, retract the wing flaps slowly, especially when flying over glassy water because a loss of altitude is not very apparent over such a surface.

To clear an obstacle after takeoff with 20° flaps, use an obstacle clearance speed of 65 KIAS for maximum performance. Takeoff distances are shown in Section 5 for this technique, and on water conditions that are smooth but non-glassy. Under some adverse combinations of takeoff weight, pressure altitude, and air temperature, operation on glassy water may require significantly longer takeoff distances to accelerate to the liftoff speed, and allowance should be made for this.

If liftoff is difficult due to high lake elevation or glassy water, the following procedure is recommended: With the floatplane in the planing attitude, apply full aileron to raise one float out of the water. When one float leaves the water, apply slight elevator back pressure to complete the takeoff. Care must be taken to stop the rising wing as soon as the float is clear of the water, and in crosswinds, raise only the downwind wing. With one float out of the water, the floatplane accelerates to takeoff speed almost instantaneously.

If porpoising is encountered while on the step, apply additional control wheel back pressure to correct the excessively nose-low attitude. If this does not correct the porpoising, immediately reduce power to idle and allow the floatplane to slow to taxi speed, at which time the takeoff can again be initiated.

For a crosswind takeoff, start the takeoff run with 20° wing flaps and the water rudders extended for better directional control. The water rudders are retracted when the floatplane is on the step; the remainder of the takeoff is normal. If the floats are lifted from the water one at a time, the downwind float should be lifted first.

ENROUTE CLIMB

A cruising climb at 25 inches of manifold pressure, 2550 RPM (approximately 75% power) and 90-100 KIAS is normally recommended. This type of climb provides better engine cooling, less engine wear, and more passenger comfort due to lower noise level, in addition to improved visibility ahead.

Cruising climbs should be conducted at 18 gal/hr up to 4000 feet and then at the fuel flow shown on the normal climb chart in Section 5 for higher altitudes.

If it is necessary to climb rapidly to clear mountains or reach favorable winds at high altitudes, the best rate-of-climb speed should be used with maximum continuous power (full throttle and 2700 RPM). This speed is 84 KIAS at sea level, decreasing to 77 KIAS at 10,000 feet. The mixture should be leaned as shown by the 2700 RPM line on the fuel flow placard on the instrument panel.

If an obstruction dictates the use of a steep climb angle, a best angle-of-climb speed should be used with flaps retracted and maximum continuous power. This speed is 63 KIAS at sea level, increasing to 71 KIAS at 10,000 feet.

CRUISE

Observe the same engine operation limitations as for the landplane. Cruise power settings and the corresponding performance data are shown on the Cruise Performance charts, figure 9 in this supplement. Range and endurance information is shown in figures 10 and 11 in this supplement.

LANDING

Power-off landings may be made with any flap setting and, in most cases, touchdown should be at the slowest possible airspeed. Performance data is shown in Section 5 for this power-off technique with full flaps.

GLASSY WATER LANDING

With glassy water conditions, flaps should be extended to 20° and enough power used to maintain a low rate of descent (approximately 200 feet per minute). The floatplane should be flown onto the water at this sink rate with no flare attempted since height above glassy water is nearly impossible to judge. Power should be reduced and back pressure increased upon contacting the surface. If this glassy water technique is used in conjunction with an obstacle clearance approach, allowance should be made for appreciably longer total distances than are shown in Section 5 to clear a 50-foot obstacle.

CROSSWIND LANDING

The wing-low slip method should be used with the upwind float contacting the surface first.

NOISE ABATEMENT

The certificated noise level for the Model U206G Floatplane at 3500 pounds maximum weight is 79.4 dB(A). No determination has been made by the Federal Aviation Administration that the noise levels of this airplane are or should be acceptable or unacceptable for operation at, into, or out of, any landing area.

SECTION 5

PERFORMANCE

INTRODUCTION

The information presented in the Introduction, Use of Performance Charts, and Sample Problem paragraphs in Section 5 of the basic handbook is applicable to the floatplane. Using this information, and the performance charts in this supplement, complete flight planning may be accomplished.

Cruise performance data in this supplement applies to the Model U206G equipped with Edo Model 582-3430 floats and is based on a standard day temperature as shown on the charts. The effect of temperature variations from standard can be determined by using the applicable cruise charts in the basic handbook for the landplane.

DEMONSTRATED OPERATING TEMPERATURE

Satisfactory engine cooling has been demonstrated for this floatplane with an outside air temperature 23°C above standard. This is not to be considered as an operating limitation. Reference should be made to Section 2 for engine operating limitations.

AIRSPEED CALIBRATION

NORMAL STATIC SOURCE

CONDITIONS:

Power required for level flight or maximum continuous power dive.

FLAPS UP														
KIAS	50	60	70	80	90	100	110	120	130	140	150	160	170	180
KCAS	59	66	74	83	92	101	111	121	131	141	150	159	169	179
FLAPS 20°														
KIAS	40	50	60	70	80	90	100	-----						
KCAS	54	59	65	73	82	92	102	-----						
FLAPS 30°														
KIAS	40	50	60	70	80	90	100	-----						
KCAS	53	57	64	74	83	93	103	-----						

Figure 4. Airspeed Calibration

STALL SPEEDS

CONDITIONS:
Power Off

NOTES:

1. Altitude loss during a stall recovery may be as much as 240 feet.
2. KIAS values are approximate.

MOST REARWARD CENTER OF GRAVITY

WEIGHT LBS	FLAP DEFLECTION	ANGLE OF BANK							
		0°		30°		45°		60°	
		KIAS	KCAS	KIAS	KCAS	KIAS	KCAS	KIAS	KCAS
3500	UP	45	56	48	60	54	67	64	79
	20°	44	53	47	57	52	63	62	75
	30°	30	51	32	55	36	61	42	72

MOST FORWARD CENTER OF GRAVITY

WEIGHT LBS	FLAP DEFLECTION	ANGLE OF BANK							
		0°		30°		45°		60°	
		KIAS	KCAS	KIAS	KCAS	KIAS	KCAS	KIAS	KCAS
3500	UP	51	59	55	63	61	70	72	83
	20°	49	56	53	60	58	67	69	79
	30°	42	55	45	59	50	65	59	78

Figure 5. Stall Speeds

TAKEOFF DISTANCE
MAXIMUM PERFORMANCE

CONDITIONS:

Flaps 20°
 2850 RPM and Full Throttle
 Mixture Set at Placard Fuel Flow
 Cowl Flaps Open
 Zero Wind

NOTE:

Decrease distances 10% for each 10 knots headwind.

WEIGHT LBS	TAKEOFF SPEED KIAS		PRESS ALT FT	0°C		10°C		20°C		30°C		40°C			
	LIFT OFF	AT 50 FT		WATER RUN	TOTAL TO CLEAR 50 FT OBS	WATER RUN	TOTAL TO CLEAR 50 FT OBS	WATER RUN	TOTAL TO CLEAR 50 FT OBS	WATER RUN	TOTAL TO CLEAR 50 FT OBS	WATER RUN	TOTAL TO CLEAR 50 FT OBS		
3500	56	65	S.L.	1545	2410	1730	2675	1945	2975	2200	3330	2495	3735		
			1000	1785	2760	2015	3075	2280	3445	2595	3880	2970	4395		
			2000	2085	3185	2365	3575	2700	4030	2700	4030	3105	4580	3595	5245
			3000	2465	3720	2820	4205	3250	4790	3785	5505	3785	5505	4455	6390
3300	54	63	4000	2955	4400	3420	5030	3995	5795	4730	6760	5695	8000		
			S.L.	1250	1980	1395	2180	1555	2410	1740	2670	1950	2970		
			1000	1435	2245	1600	2480	1795	2755	2020	3070	2285	3435		
			2000	1655	2560	1855	2850	2095	3180	2375	3565	2705	4020		
3100	53	61	3000	1925	2950	2175	3300	2470	3705	2825	4190	3255	4775		
			4000	2265	3430	2580	3865	2960	4385	3420	5005	4000	5775		
			S.L.	1015	1630	1120	1785	1240	1960	1380	2160	1535	2380		
			1000	1150	1835	1275	2015	1420	2220	1585	2455	1775	2720		
			2000	1315	2075	1465	2285	1635	2530	1835	2810	2065	3135		
			3000	1510	2360	1690	2615	1900	2910	2145	3250	2435	3650		
			4000	1755	2710	1975	3020	2235	3380	2540	3805	2910	4310		

Figure 6. Takeoff Distance

MAXIMUM RATE OF CLIMB

CONDITIONS:
Flaps Up
2700 RPM
Full Throttle
Mixture Set at Placard Fuel Flow
Cowl Flaps Open

MIXTURE SETTING	
PRESS ALT	GPH
S.L.	23
4000	21
8000	19
12,000	17

WEIGHT LBS	PRESS ALT FT	CLIMB SPEED KIAS	RATE OF CLIMB - FPM		
			0°C	20°C	40°C
3500	S.L.	84	995	900	810
	2000	82	855	770	680
	4000	81	720	635	550
	6000	80	585	500	425
	8000	78	450	370	295
	10,000	77	315	240	---
	12,000	76	185	110	---
3300	S.L.	82	1100	1005	915
	2000	80	955	865	780
	4000	79	815	730	645
	6000	78	675	590	515
	8000	77	535	455	380
	10,000	76	395	320	---
	12,000	75	260	185	---
3100	S.L.	80	1215	1120	1030
	2000	79	1065	975	890
	4000	78	915	835	750
	6000	76	770	690	610
	8000	76	625	550	470
	10,000	75	485	410	---
	12,000	73	340	270	---

Figure 7. Maximum Rate of Climb

TIME, FUEL, AND DISTANCE TO CLIMB

MAXIMUM RATE OF CLIMB

CONDITIONS:

- Flaps Up
- 2700 RPM
- Full Throttle
- Mixture Set at Placard Fuel Flow
- Cowl Flaps Open
- Standard Temperature

MIXTURE SETTING	
PRESS ALT	GPH
S.L.	23
4000	21
8000	19
12,000	17

NOTES:

1. Add 2.0 gallons of fuel for engine start, taxi and takeoff allowance.
2. Increase time, fuel and distance by 10% for each 10°C above standard temperature.
3. Distances shown are based on zero wind.

WEIGHT LBS	PRESS ALT FT	CLIMB SPEED KIAS	RATE OF CLIMB FPM	FROM SEA LEVEL		
				TIME MIN	FUEL USED GALLONS	DISTANCE NM
3500	S.L.	84	925	0	0	0
	2000	82	805	2	0.9	3
	4000	81	690	5	1.8	7
	6000	80	570	8	2.9	12
	8000	78	455	12	4.2	17
	10,000	77	335	18	5.8	25
	12,000	76	215	25	8.0	36
3300	S.L.	82	1030	0	0	0
	2000	80	905	2	0.8	3
	4000	79	785	4	1.6	6
	6000	78	660	7	2.6	10
	8000	77	540	11	3.7	15
	10,000	76	415	15	5.0	21
	12,000	75	295	21	6.7	30
3100	S.L.	80	1145	0	0	0
	2000	78	1015	2	0.7	2
	4000	77	885	4	1.5	5
	6000	76	760	6	2.3	9
	8000	75	630	9	3.2	13
	10,000	74	505	13	4.4	18
	12,000	73	375	18	5.7	25

Figure 8. Time, Fuel, and Distance to Climb (Sheet 1 of 2)

TIME, FUEL, AND DISTANCE TO CLIMB

NORMAL CLIMB - 95 KIAS

CONDITIONS:

- Flaps Up
- 2550 RPM
- 25 Inches Hg or Full Throttle
- Cowl Flaps Open
- Standard Temperature

MIXTURE SETTING	
PRESS ALT	GPH
S.L. to 4000	18
6000	17
8000	16

NOTES:

1. Add 2.0 gallons of fuel for engine start, taxi and takeoff allowance.
2. Increase time, fuel and distance by 10% for each 8°C above standard temperature.
3. Distances shown are based on zero wind.

WEIGHT LBS	PRESS ALT FT	RATE OF CLIMB FPM	FROM SEA LEVEL		
			TIME MIN	FUEL USED GALLONS	DISTANCE NM
3500	S.L.	570	0	0	0
	2000	570	4	1.1	5
	4000	560	7	2.1	11
	6000	435	11	3.3	18
	8000	315	17	4.8	27
3300	S.L.	645	0	0	0
	2000	645	3	0.9	5
	4000	640	6	1.8	10
	6000	510	10	2.9	16
	8000	380	14	4.1	24
3100	S.L.	730	0	0	0
	2000	730	3	0.8	4
	4000	725	5	1.6	9
	6000	590	9	2.5	14
	8000	455	12	3.6	21

Figure 8. Time, Fuel, and Distance to Climb (Sheet 2 of 2)

CRUISE PERFORMANCE**PRESSURE ALTITUDE 2000 FEET****CONDITIONS:**

3500 Pounds
Recommended Lean Mixture
Cowl Flaps Closed

NOTE

For best fuel economy at 65% power or less, operate at 1 GPH leaner than shown in this chart or at peak EGT if an EGT indicator is installed.

		STANDARD TEMPERATURE 11°C		
RPM	MP	% BHP	KTAS	GPH
2550	25	78	128	16.3
	24	74	126	15.4
	23	70	123	14.6
	22	65	120	13.7
2500	25	76	127	15.8
	24	72	124	15.0
	23	68	122	14.2
	22	64	118	13.4
2400	25	71	124	14.8
	24	67	121	14.1
	23	63	118	13.3
	22	59	115	12.5
2300	25	66	121	13.9
	24	63	118	13.2
	23	59	114	12.5
	22	56	111	11.8
2200	25	61	116	12.9
	24	58	113	12.3
	23	55	110	11.6
	22	51	106	11.0
	21	48	101	10.4
	20	45	97	9.7

Figure 9. Cruise Performance (Sheet 1 of 6)

CRUISE PERFORMANCE

PRESSURE ALTITUDE 4000 FEET

CONDITIONS:
3500 Pounds
Recommended Lean Mixture
Cowl Flaps Closed

NOTE
For best fuel economy at 65% power or less, operate at 1 GPH leaner than shown in this chart or at peak EGT if an EGT indicator is installed.

		STANDARD TEMPERATURE 7°C		
RPM	MP	% BHP	KTAS	GPH
2550	24	76	129	15.8
	23	72	127	15.0
	22	67	124	14.1
	21	63	120	13.3
2500	25	78	130	16.2
	24	74	128	15.4
	23	70	125	14.6
	22	65	122	13.7
2400	25	72	127	15.1
	24	69	124	14.4
	23	65	121	13.6
	22	61	118	12.9
2300	25	68	124	14.2
	24	64	121	13.5
	23	61	118	12.8
	22	57	114	12.1
2200	25	63	120	13.2
	24	59	116	12.5
	23	56	113	11.9
	22	53	109	11.3
	21	50	105	10.7
	20	46	100	10.0
	19	43	94	9.4

Figure 9. Cruise Performance (Sheet 2 of 6)

CRUISE PERFORMANCE

PRESSURE ALTITUDE 6000 FEET

CONDITIONS:
3500 Pounds
Recommended Lean Mixture
Cowl Flaps Closed

NOTE

For best fuel economy at 65% power or less, operate at 1 GPH leaner than shown in this chart or at peak EGT if an EGT indicator is installed.

		STANDARD TEMPERATURE 3°C		
RPM	MP	% BHP	KTAS	GPH
2550	24	78	133	16.2
	23	74	130	15.4
	22	69	127	14.5
	21	65	124	13.7
2500	24	75	132	15.8
	23	71	129	14.9
	22	67	126	14.1
	21	63	122	13.3
2400	24	70	128	14.7
	23	67	125	14.0
	22	63	122	13.2
	21	59	118	12.5
2300	24	66	124	13.8
	23	62	121	13.1
	22	59	117	12.4
	21	55	113	11.8
2200	24	61	120	12.8
	23	58	116	12.2
	22	54	112	11.6
	21	51	108	11.0
	20	48	103	10.3
	19	44	98	9.7

Figure 9. Cruise Performance (Sheet 3 of 6)

CRUISE PERFORMANCE

PRESSURE ALTITUDE 8000 FEET

CONDITIONS:
3500 Pounds
Recommended Lean Mixture
Cowl Flaps Closed

NOTE
For best fuel economy at 65% power or less, operate at 1 GPH leaner than shown in this chart or at peak EGT if an EGT indicator is installed.

		STANDARD TEMPERATURE -1°C		
RPM	MP	% BHP	KTAS	GPH
2550	22	71	131	14.9
	21	67	128	14.1
	20	63	124	13.3
	19	59	119	12.4
2500	22	69	129	14.5
	21	65	126	13.7
	20	61	122	12.9
	19	57	117	12.1
2400	22	65	125	13.6
	21	61	121	12.8
	20	57	117	12.1
	19	53	112	11.4
2300	22	61	121	12.8
	21	57	117	12.1
	20	53	112	11.4
	19	50	107	10.7
2200	22	56	116	11.9
	21	53	111	11.3
	20	49	107	10.7
	19	46	101	10.0
	18	43	95	9.4

Figure 9. Cruise Performance (Sheet 4 of 6)

CRUISE PERFORMANCE**PRESSURE ALTITUDE 10,000 FEET****CONDITIONS:**

3500 Pounds
Recommended Lean Mixture
Cowl Flaps Closed

NOTE

For best fuel economy at 65% power or less, operate at 1 GPH leaner than shown in this chart or at peak EGT if an EGT indicator is installed.

		STANDARD TEMPERATURE -5°C		
RPM	MP	% BHP	KTAS	GPH
2550	20	65	128	13.7
	19	61	123	12.8
	18	56	118	12.0
	17	52	112	11.2
2500	20	63	125	13.3
	19	59	121	12.4
	18	55	115	11.6
	17	50	109	10.8
2400	20	59	121	12.4
	19	55	116	11.7
	18	51	110	11.0
	17	47	104	10.2
2300	20	55	116	11.7
	19	51	111	11.0
	18	48	105	10.3
	17	44	98	9.6
2200	20	51	110	11.0
	19	48	105	10.3
	18	44	98	9.7

Figure 9. Cruise Performance (Sheet 5 of 6)

CRUISE PERFORMANCE
PRESSURE ALTITUDE 12,000 FEET

CONDITIONS:
3500 Pounds
Recommended Lean Mixture
Cowl Flaps Closed

NOTE

For best fuel economy, operate at 1 GPH leaner than shown in this chart or at peak EGT if an EGT indicator is installed.

		STANDARD TEMPERATURE -9°C		
RPM	MP	% BHP	KTAS	GPH
2550	18	58	122	12.3
	17	54	116	11.5
	16	50	109	10.7
	15	45	100	9.8
2500	18	57	119	12.0
	17	52	113	11.2
	16	48	106	10.4
2400	18	53	114	11.3
	17	49	107	10.6
	16	45	99	9.8
2300	18	49	108	10.6
	17	46	101	9.9
2200	18	46	102	10.0

Figure 9. Cruise Performance (Sheet 6 of 6)

RANGE PROFILE

45 MINUTES RESERVE 65 GALLONS USABLE FUEL

CONDITIONS:

3500 Pounds
Recommended Lean Mixture for Cruise
Standard Temperature
Zero Wind

NOTE:

This chart allows for the fuel used for engine start, taxi, takeoff and climb, and the distance during a normal climb up to 8000 feet and maximum climb above 8000 feet.

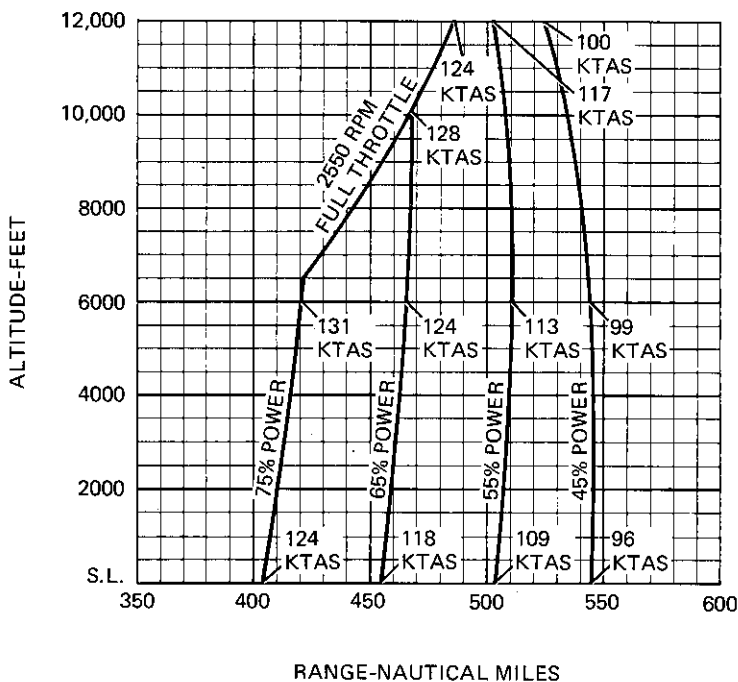

Figure 10. Range Profile (Sheet 1 of 2)

RANGE PROFILE

45 MINUTES RESERVE 88 GALLONS USABLE FUEL

CONDITIONS:

3500 Pounds
Recommended Lean Mixture for Cruise
Standard Temperature
Zero Wind

NOTE:

This chart allows for the fuel used for engine start, taxi, takeoff and climb, and the distance during a normal climb up to 8000 feet and maximum climb above 8000 feet.

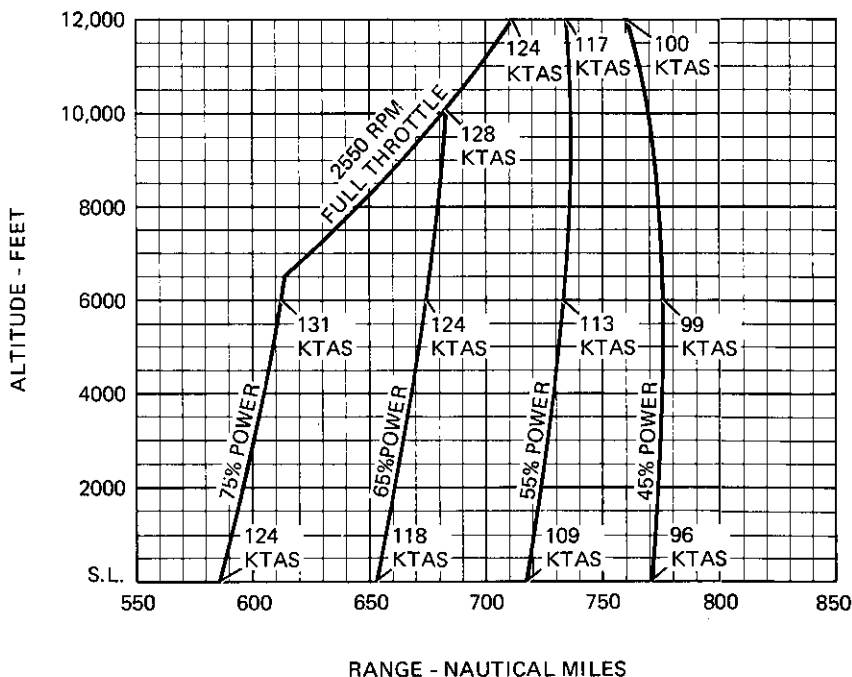

Figure 10. Range Profile (Sheet 2 of 2)

ENDURANCE PROFILE

45 MINUTES RESERVE
65 GALLONS USABLE FUEL

CONDITIONS

3500 Pounds
Recommended Lean Mixture for Cruise
Standard Temperature

NOTE:

This chart allows for the fuel used for engine start, taxi, takeoff and climb, and the time during a normal climb up to 8000 feet and maximum climb above 8000 feet.

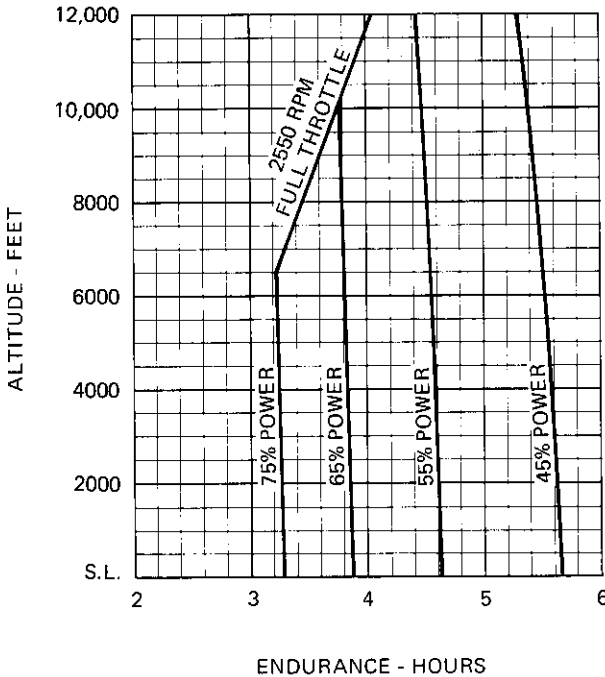

Figure 11. Endurance Profile (Sheet 1 of 2)

ENDURANCE PROFILE

45 MINUTES RESERVE
88 GALLONS USABLE FUEL

CONDITIONS:
3500 Pounds
Recommended Lean Mixture for Cruise
Standard Temperature

NOTE:
This chart allows for the fuel used for engine start, taxi, takeoff and climb, and the time during a normal climb up to 8000 feet and maximum climb above 8000 feet.

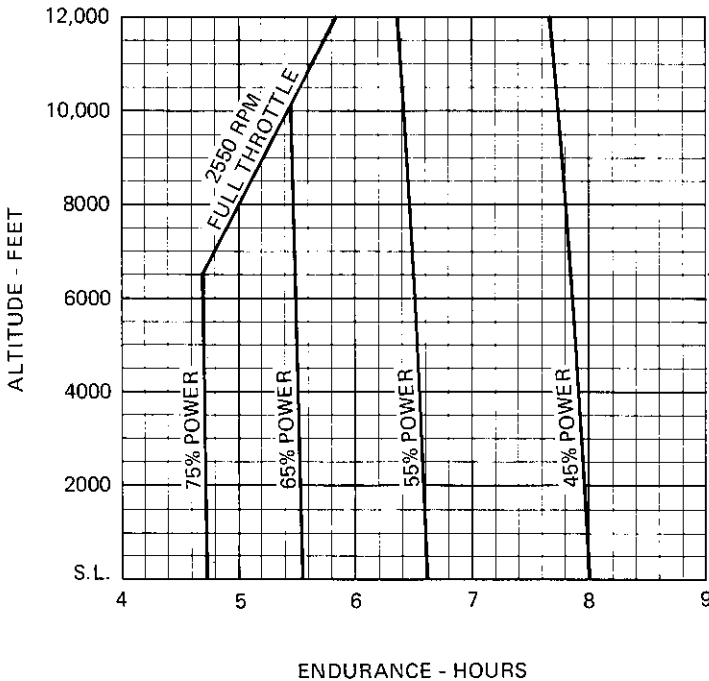

Figure 11. Endurance Profile (Sheet 2 of 2)

**LANDING DISTANCE
 MAXIMUM PERFORMANCE**

CONDITIONS:
 Flaps 30°
 Power Off
 Zero Wind

NOTES:

1. Refer to Section 4 for recommended technique if water surface is glassy.
2. Decrease distances 10% for each 10 knots headwind.

WEIGHT LBS	SPEED AT 50 FT KIAS	PRESS ALT FT	0°C		10°C		20°C		30°C		40°C	
			WATER RUN	TOTAL TO CLEAR 50 FT OBS	WATER RUN	TOTAL TO CLEAR 50 FT OBS	WATER RUN	TOTAL TO CLEAR 50 FT OBS	WATER RUN	TOTAL TO CLEAR 50 FT OBS	WATER RUN	TOTAL TO CLEAR 50 FT OBS
3500	70	S.L. 1000 2000 3000 4000	740	1605	765	1650	795	1700	820	1745	850	1795
			765	1650	795	1700	825	1750	850	1800	880	1850
			795	1700	825	1755	855	1805	885	1855	910	1905
			825	1755	855	1805	885	1860	915	1910	945	1965
			855	1805	885	1860	920	1920	950	1970	980	2025

Figure 12. Landing Distance

SECTION 6 WEIGHT & BALANCE

INTRODUCTION

Weight and balance information contained in the basic handbook generally should be used, and will enable you to operate the floatplane within the prescribed weight and center of gravity limitations. The changed information specifically required for operation of the Model U206G equipped with Edo Model 582-3430 floats is presented in this section.

NOTE

When floats are installed, it is possible to exceed the maximum takeoff weight with all seats occupied and minimum fuel.

It is the responsibility of the pilot to ensure that the floatplane is loaded properly.

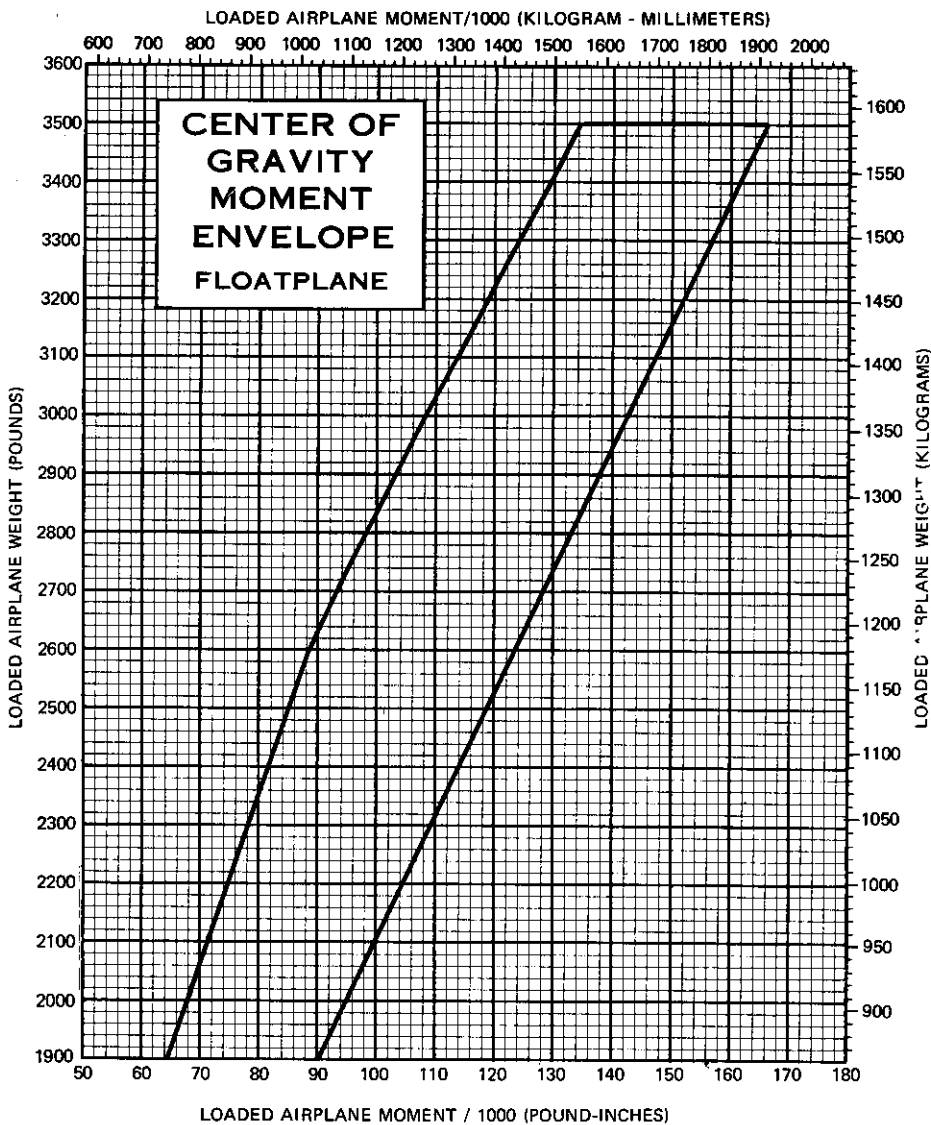

Figure 13. Center of Gravity Moment Envelope

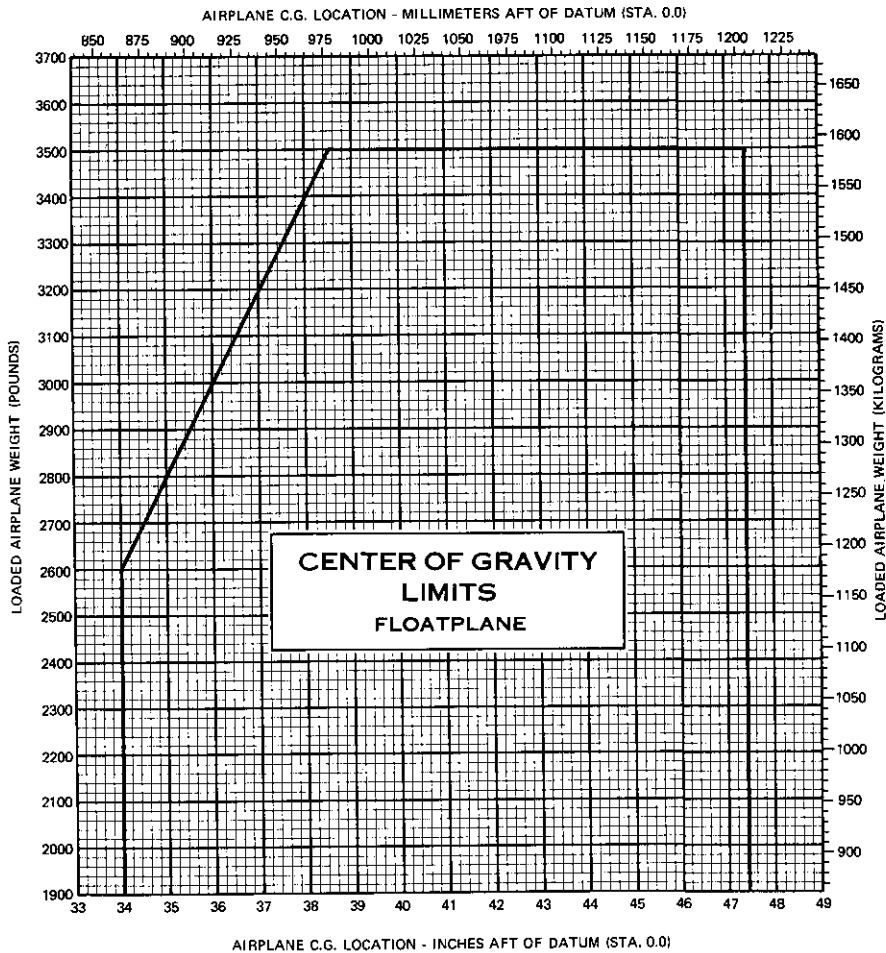

Figure 14. Center of Gravity Limits

SECTION 7

AIRPLANE & SYSTEMS DESCRIPTION

INTRODUCTION

This section contains a description of the modifications and equipment associated specifically with the installation of Edo Model 582-3430 floats on the Model U206G.

THE FLOATPLANE

The floatplane is identical to the landplane with the following exceptions:

1. Floats, incorporating a water rudder steering system, replace the landing gear. A water rudder retraction handle, connected to the water rudders by cables, is located on the cabin floor between the front seats.
2. Additional fuselage structure is added to support the float installation (includes removable cover panels for the nose gear opening).
3. An additional structural "V" brace is installed between the upper corners of the windshield and the cowl deck.
4. The stall sensor is relocated for floatplane operations.
5. An enlarged rudder, and a redesigned vertical fin, tailcone stinger and flashing beacon installation replace the standard rudder, fin, stinger and flashing beacon.
6. A ventral fin is installed on the bottom of the tailcone for additional directional stability.
7. Four special placards are added to the instrument panel.
8. The standard engine tail pipes are replaced with tail pipes having extensions for deflecting hot gases around the front float struts.
9. Special cowl flap side extensions and cowl flap control linkage extensions are added to ensure proper engine cooling.
10. A rudder trim system bungee with a lighter spring replaces the standard bungee.
11. The wing flap limit switch is adjusted to restrict the maximum flap travel to 30°.
12. Hoisting provisions are added to the top of the fuselage.
13. The airplane has additional corrosion-proofing and stainless steel control cables.
14. The elevator trim tab rigging is changed to increase the maximum down travel.

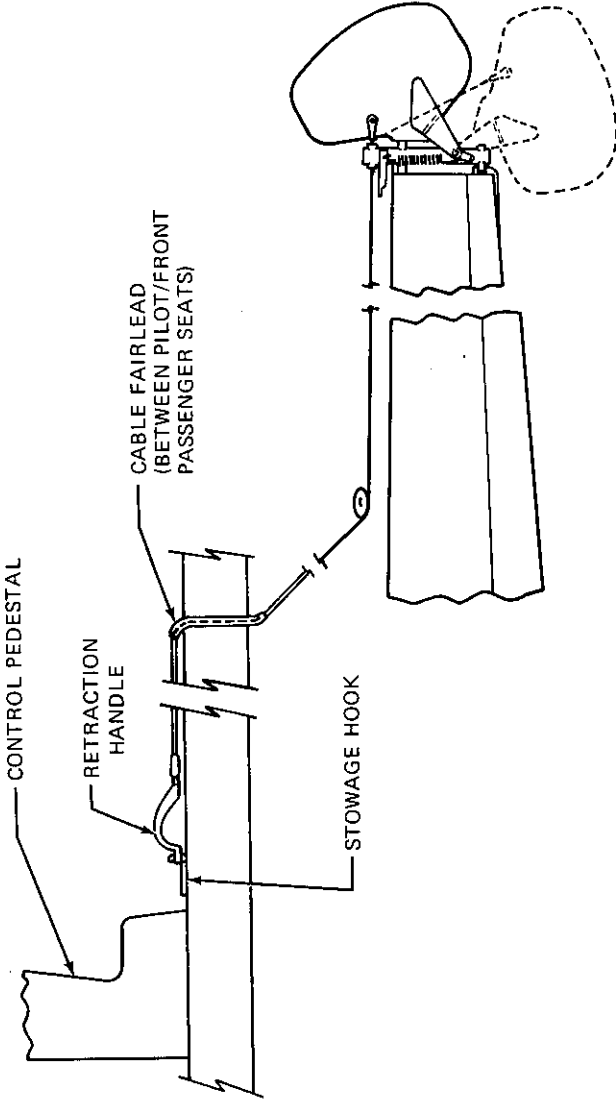

CONDITION: WATER RUDDERS RETRACTED

Figure 15. Water Rudder Retraction System

15. Fueling steps and assist handles are mounted on the forward fuselage, and steps are mounted on the wing struts to aid in refueling the floatplane.

WATER RUDDER SYSTEM.

Retractable water rudders (figure 15), mounted at the aft end of each float, are connected by a system of cables and springs to the rudder pedals. Normal rudder pedal operation moves the water rudders to provide steering control (figure 16) for taxiing.

A water rudder retraction handle, located on the cabin floor between the front seats, is used to manually raise and lower the water rudders. During takeoff, landing, and in flight, the handle should be secured on the stowage hook located on the cabin floor just aft of the control pedestal. With the handle in this position, the water rudders are up. When the handle is removed from the hook and allowed to move full aft, the water rudders extend to the full down position for taxiing.

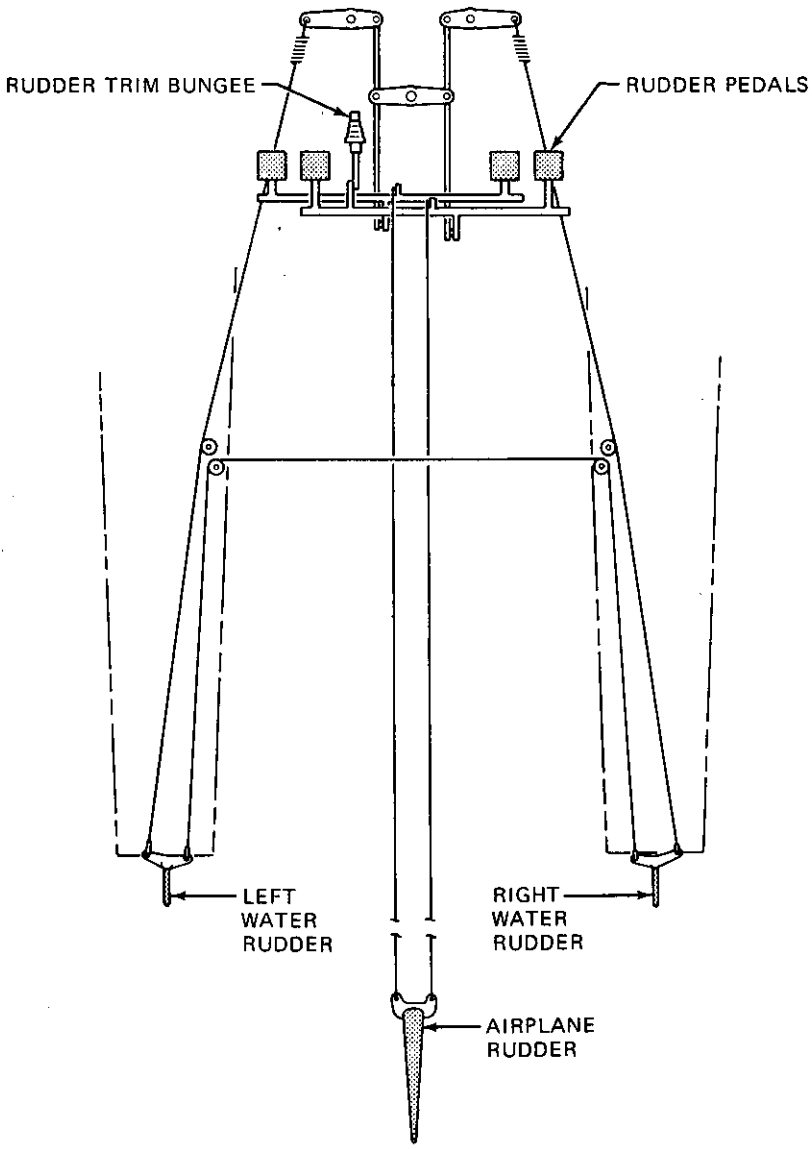

Figure 16. Water Rudder Steering System

SECTION 8

AIRPLANE HANDLING, SERVICE & MAINTENANCE

INTRODUCTION

Section 8 of the basic handbook applies, in general, to the floatplane. The following recommended procedures apply specifically to the floatplane operation. (Cleaning and maintenance of the floats should be accomplished as suggested in the Edo Corporation Service and Maintenance Manual for Floats.)

MOORING

Proper securing of the floatplane can vary considerably, depending on the type of operation involved and the facilities available. Each operator should use the method most appropriate for his operation. Some of the most common mooring alternatives are as follows:

1. The floatplane can be moored to a buoy, using a yoke tied to the forward float cleats, so that it will freely weathervane into the wind.
2. The floatplane can be secured to a dock using the fore and aft cleats of one float, although this method is generally not recommended unless the water is calm and the floatplane is attended.
3. The floatplane may be removed from the water (by use of a special lift under the spreader bars) and secured by using the wing tie-down rings and float cleats. If conditions permit the floatplane to be beached, ensure that the shoreline is free of rocks or abrasive material that may damage the floats.

SERVICING

Service the airplane in accordance with Section 8 of the basic handbook.

SUPPLEMENT

AMBULANCE KIT

SECTION 1 GENERAL

The ambulance kit (see figure 1) enables the airplane to be used to transport a patient on a stretcher plus a medical attendant on a jump seat beside the stretcher. To provide space for the required equipment, the second and third row seats are removed from the airplane and the following items are installed:

1. A patient stretcher with a lap belt and shoulder harness assembly is positioned on the right side of the airplane adjacent to the cargo door. Special cups are installed in the floorboards to accept the aft stretcher wheels.
2. An attendant seat with a removable back is attached to special seat rails (LH outboard only) and is positioned next to the patient's stretcher.
3. An oxygen bottle with regulator, delivery hose and mask assembly, is mounted vertically on a special bracket which latches to the LH seat rails.
4. An eyebolt for hanging a plasma or intravenous bottle is attached to the cabin headliner above the patient.
5. A limitations placard is added to the LH cabin sidewall just below the center side window.

NOTE

The attendant's seat is built with a removable back which enables the attendant to face either forward or aft. The seat should be installed with the latching pin at the left forward side of the seat.

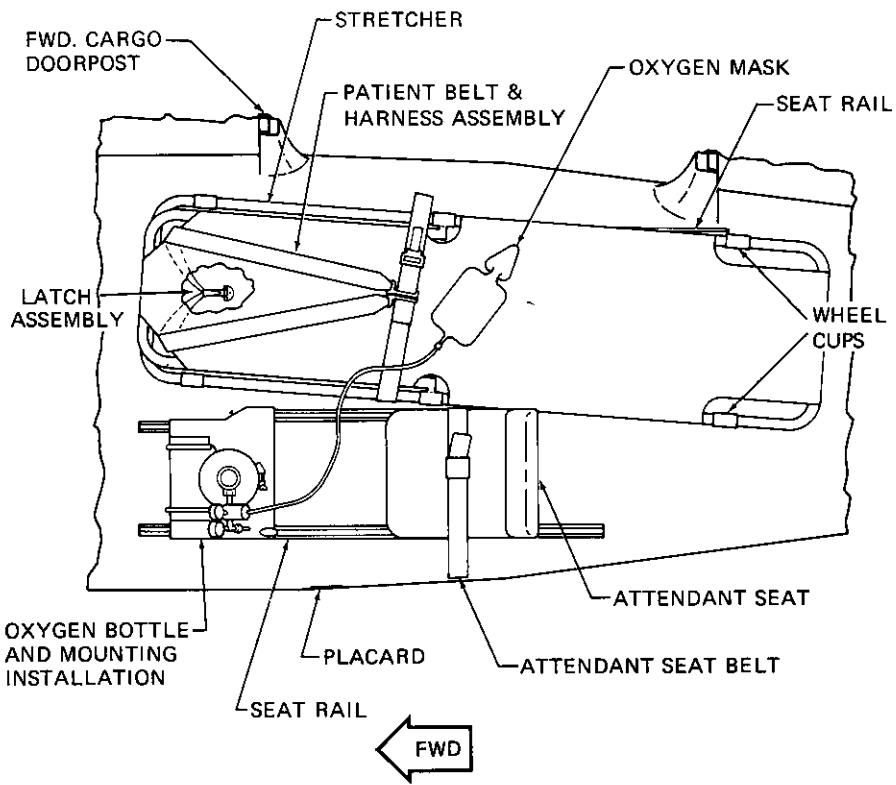

Figure 1. Ambulance Kit

SECTION 2 LIMITATIONS

The following information must be presented in the form of a placard attached to the LH cabin sidewall in full view of the attendant:

**ATTENDANT MUST FACE FORWARD
DURING TAKEOFF & LANDING**

SECTION 3

EMERGENCY PROCEDURES

There is no change to the airplane emergency procedures when the ambulance kit is installed.

SECTION 4

NORMAL PROCEDURES

The stretcher belts and harnesses should be attached to the floor fittings in the airplane as shown in figure 1. Load the stretcher inside the airplane with the patient's head forward and with the aft stretcher wheels resting in the cups provided. Route the harness assembly up through the corners of the stretcher and over the patient's shoulders. Route the belt assemblies over the stretcher and the patient, then thread through the harness loops. Connect the belt buckle and adjust all belts to secure the stretcher and patient just firmly enough to resist any forward or aft motion.

SECTION 5

PERFORMANCE

There is no change to airplane performance when the ambulance kit is installed.

SUPPLEMENT

CAMERA PROVISIONS INSTALLATION

SECTION 1 GENERAL

The camera provisions installation enables the airplane to be used for aerial photography using commercial aerial photography equipment such as the Fairchild F-224 Cartographic or the Wild RC-8 cameras. In order to accommodate this equipment, the fuselage belly and floorboard structure is modified to provide a circular opening approximately 16 inches in diameter in the area of the second row seats, which are removed. The installation provides a floorboard and a belly cover to be used for closing off the opening when the airplane is not configured for photography. In addition, a small padded jump seat is installed immediately aft of the camera opening to be occupied by the camera operator, as well as special fittings (aft of the seat) for the operator's seat belts. A special view finder, located between the jump seat and the camera opening, is also provided.

SECTION 2 LIMITATIONS

The following information must be presented in the form of a placard located on the floorboard cover of the camera opening:

WARNING

WHEN REMOVING COVER PLATES FOR
AERIAL PHOTOGRAPHIC FLIGHT INSTALL
A NON-POROUS FABRIC SEAL BETWEEN
CAMERA AND FLOORBOARD OPENING
TO AVOID CARBON MONOXIDE
CONTAMINATION IN CABIN.

SECTION 3 EMERGENCY PROCEDURES

There is no change to the airplane emergency procedures when camera provisions are installed.

SECTION 4 NORMAL PROCEDURES

For camera operating data, refer to the particular instructions supplied by the camera manufacturer.

SECTION 5 PERFORMANCE

There is no change to the airplane performance when camera provisions are installed.

SUPPLEMENT

CARGO PACK

SECTION 1

GENERAL

The cargo pack provides additional cargo and baggage space. The basic shell of the cargo pack, including the loading door, is fabricated from fiberglass. Corrugated aluminum forms the inner floor of the pack. A loading door is located on the left side of the pack, and is hinged at the bottom. It is secured in the closed position by two quick-release fasteners, and has a key-operated lock.

The volume of the cargo pack is 16 cubic feet. Dimensions of the pack and its loading door opening are contained in Section 6 of the basic handbook. The pack is designed to accommodate three "two-suiters", plus other small miscellaneous articles.

The pack is attached to the bottom of the fuselage with screws and, after the initial installation, can readily be removed or installed. Complete instructions for installation of the cargo pack, and required modifications to the nose gear access panels, fuel pump vent line and cowl flaps are contained in the Accessory Kit and Service Manual.

SECTION 2

LIMITATIONS

The maximum approved takeoff flap setting at a maximum weight of 3600 pounds is 10°. At weights of 3450 pounds or less, up to 20° flaps is approved.

The ADF bearing accuracy may be adversely affected by the type and/or arrangement of the cargo pack contents.

Cowl flap extensions must be installed with the cargo pack.

The following information must be presented in the form of a placard, located on the inside of the cargo pack door:

Refer to weight & balance data for baggage/cargo loading. Never exceed 300 lbs. cargo weight. Cowl flap extensions must be installed with cargo pack.

SECTION 3 EMERGENCY PROCEDURES

There is no change to the airplane emergency procedures when the cargo pack is installed.

SECTION 4 NORMAL PROCEDURES

Because of the effect of the cargo pack on climb performance, the maximum flap deflection approved for takeoff is 10° whenever the airplane is operated at weights above 3450 pounds. When operated at or below this weight, up to 20° of flap may be used.

At takeoff weights above 3450 pounds, short field takeoffs with 10° flaps should be conducted using a speed of 68 KIAS at the 50-foot obstacle. At weights of 3450 pounds or less, the speeds on the Takeoff Distance chart in Section 5 of the basic handbook and a 20° flap setting may be used. All other speeds remain unchanged from those listed in Section 4 of the basic handbook.

SECTION 5 PERFORMANCE

To obtain takeoff performance of the airplane with a cargo pack installed and using 10° flaps, increase both ground roll and total distance over the 50-foot obstacle by 10% over that found in Section 5 of the basic handbook. This procedure is required only when operating at weights

above 3450 pounds. When operating at or below this weight, use 20° flaps and takeoff data in Section 5 of the basic handbook.

The climb performance of the airplane equipped with a cargo pack is approximately 45 ft/min less than that shown in the Rate of Climb chart (figure 5-5 of the basic handbook) for the standard airplane.

To obtain speed performance for the airplane equipped with a cargo pack, the speed differentials shown in figure 1 should be subtracted from the KTAS figures shown in the Cruise Performance charts for the standard airplane.

SPEED DIFFERENTIAL TABLE

% BHP	SPEED DIFFERENTIAL KNOTS
75	-4
65	-4
55	-4
45	-5

Figure 1. Speed Differential Table

DEMONSTRATED OPERATING TEMPERATURE

Satisfactory engine cooling has been demonstrated for this airplane with an outside air temperature 23°C above standard. This is not to be considered as an operating limitation. Reference should be made to Section 2 of the basic handbook for engine operating limitations.

SUPPLEMENT

CLUB SEATING AND SIDEWALL TABLE

SECTION 1 GENERAL

The club-style seating arrangement is similar to the conventional seating arrangement except that provisions are made to mount the second row seats facing aft. With this configuration, a space is created between the second and third row passengers which contributes significantly to the "club" atmosphere. In addition, a small, sidewall-mounted table is available with the club seating option. When not in use, the table folds conveniently for stowage in its own self-contained rack attached to the left cabin sidewall between the second and third row seats.

SECTION 2 LIMITATIONS

If the club seating arrangement also includes the sidewall table, the following information must be presented in the form of a placard attached to the top of the table:

STOW TABLE DURING TAKEOFF & LANDING

SECTION 3 EMERGENCY PROCEDURES

There is no change to the airplane emergency procedures when club seating is installed.

SECTION 4

NORMAL PROCEDURES

The two aft-facing two-way adjustable seats may be moved forward or aft and the seat backs are non-adjustable. Position the seat by lifting up on the lever on the rear inboard corner of each seat and slide the seat into position; then release the handle and check that the seat is locked in place.

The club seating installation includes special headrests for all seat positions. To adjust a headrest on a forward-facing seat, apply enough pressure to raise or lower it to the desired level. The headrest is removed by raising it until it disengages from the seat back. Headrests on aft-facing seats are attached with velcro fasteners.

SECTION 5

PERFORMANCE

There is no change to the airplane performance when club seating is installed.

SUPPLEMENT

CONVENIENCE TABLE

SECTION 1

GENERAL

The convenience table and its stowage compartment are installed on the back of the pilot's or copilot's seat for use by the second row passengers. The table is equipped with guides which follow tracks inside the stowage compartment.

SECTION 2

LIMITATIONS

The following information must be presented in the form of a placard located on the back of the convenience table.

<p>STOW LEAF DURING TAKEOFF AND LANDING</p>

SECTION 3

EMERGENCY PROCEDURES

There is no change to the airplane emergency procedures when the convenience table is installed.

SECTION 4

NORMAL PROCEDURES

To remove the table from the stowage compartment, grasp the handle near the top edge of the leaf, slide it upward and aft until the leaf contacts the stops at the top of the compartment. Stowing the table is accomplished by rotating it upward and sliding it back down into the stowage compartment.

SECTION 5

PERFORMANCE

There is no change to the airplane performance when the convenience table is installed.

SUPPLEMENT

DIGITAL CLOCK

SECTION 1

GENERAL

The Astro Tech LC-2 Quartz Chronometer (see figure 1) is a precision, solid state time keeping device which will display to the pilot the time-of-day, the calendar date, and the elapsed time interval between a series of selected events, such as in-flight check points or legs of a cross-country flight, etc. These three modes of operation function independently and can be alternately selected for viewing on the four digit liquid crystal display (LCD) on the front face of the instrument. Three push button type switches directly below the display control all time keeping functions. These control functions are summarized in figures 2 and 3.

The digital display features an internal light (back light) to ensure good visibility under low cabin lighting conditions or at night. The intensity of the back light is controlled by the ENG-RADIO lights rheostat. In addition, the display incorporates a test function (see figure 1) which allows checking that all elements of the display are operating. To activate the test function, press the LH and RH buttons at the same time.

SECTION 2

LIMITATIONS

There is no change to the airplane limitations when the digital clock is installed.

SECTION 3

EMERGENCY PROCEDURES

There is no change to the airplane emergency procedures when the digital clock is installed.

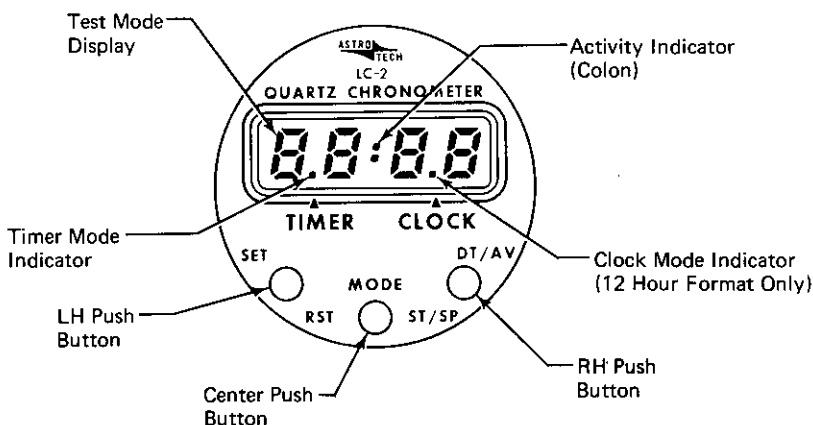

Figure 1. Digital Clock

SECTION 4

NORMAL PROCEDURES

CLOCK AND DATE OPERATION

When operating in the clock mode (see figure 2), the display shows the time of day in hours and minutes while the activity indicator (colon) will blink off for one second each ten seconds to indicate proper functioning. If the RH push button is pressed momentarily, while in the clock mode, the calendar date appears numerically on the display with month of year to the left of the colon and day of the month shown to the right of the colon. The display automatically returns to the clock mode after approximately 1.5 seconds. However, if the RH button is pressed continuously longer than approximately two seconds, the display will return from the date to the clock mode with the activity indicator (colon) blinking altered to show continuously or be blanked completely from the display. Should this occur, simply press the RH button again for two seconds or longer, and correct colon blinking will be restored.

NOTE

The clock mode is set at the factory to operate in the 24-hour format. However, 12-hour format operation may be selected by changing the position of an internal slide switch accessible through a small hole on the bottom of the instrument case. Notice that in the 24-hour format, the clock mode indicator does not appear.

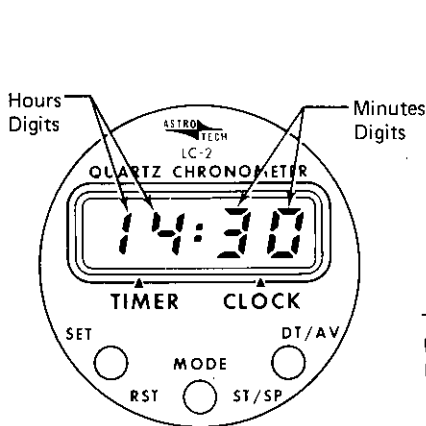

LH Button: Sets date and time of day (when used with RH button).

Center Button: Alternately displays clock or timer status

RH Button: Shows calendar date momentarily; display returns to clock mode after 1.5 seconds.

Figure 2. Clock Mode

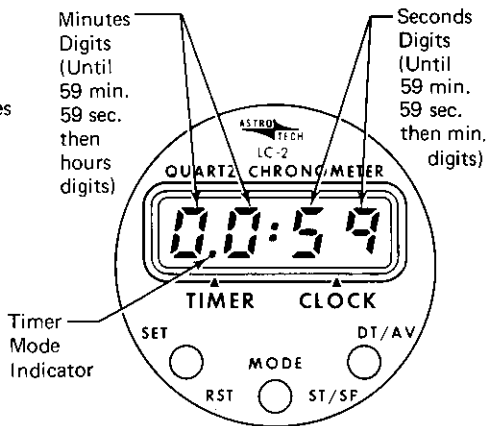

LH Button: Resets timer to "zero".

Center Button: Alternately displays clock or timer status

RH Button: Alternately starts and stops timer; timer starts from any previously accumulated total.

Figure 3. Timer Mode

SETTING CORRECT DATE AND TIME

The correct date and time are set while in the clock mode using the LH and RH push buttons as follows: press the LH button once to cause the date to appear with the month flashing. Press the RH button to cause the month to advance at one per second (holding button), or one per push until the correct month appears. Push the LH button again to cause the day of month to appear flashing, then advance as before using RH button until correct day of month appears.

Once set correctly, the date advances automatically at midnight each day until February 29 of each leap year, at which time one day must be added manually.

Pressing the LH button two additional times will cause the time to appear with the hours digits flashing. Using the RH button as before, advance the hour digits to the correct hour as referenced to a known time standard. Another push of the LH button will now cause the minutes digits to flash. Advance the minutes digits to the next whole minute to be reached by the time standard and "hold" the display by pressing the LH button once more. At the exact instant the time standard reaches the value "held" by the display, press the RH button to restart normal clock timing, which will now be synchronized to the time standard.

In some instances, however, it may not be necessary to advance the minutes digits of the clock; for example when changing time zones. In such a case, do not advance the minutes digits while they are flashing. Instead, press the LH button again, and the clock returns to the normal time keeping mode without altering the minutes timing.

TIMER OPERATION

The completely independent 24-hour elapsed timer (see figure 3) is operated as follows: press the center (MODE) push button until the timer mode indicator appears. Reset the display to "zero" by pressing the LH button. Begin timing an event by pressing the RH button. The timer will begin counting in minutes and seconds and the colon (activity indicator) will blink off for 1/10 second each second. When 59 minutes 59 seconds have accumulated, the timer changes to count in hours and minutes, up to a maximum of 23 hours, 59 minutes. During the count in hours and minutes, the colon blinks off for one second each ten seconds. To stop timing the event, press the RH button once again and the time shown by the display is "frozen". Successive pushes of the RH button will alternately restart the count from the "held" total or stop the count at a new total. The hold status of the timer can be recognized by lack of colon activity, either continuously on or continuously off. The timer can be reset to "zero" at anytime using the LH button.

SECTION 5 PERFORMANCE

There is no change to the airplane performance when the digital clock is installed.

SUPPLEMENT

ELECTRIC ELEVATOR TRIM SYSTEM

SECTION 1 GENERAL

The electric elevator trim system provides a simple method of relieving pitch control pressures without interrupting other control operations to adjust the manual elevator trim wheel. The system is controlled by a slide-type trim switch on the top of the left control wheel grip and a disengage switch located on the left side of the control wheel pad. Pushing the trim switch to the forward position, labeled DN, moves the elevator trim tab in the "nose down" direction; conversely, pulling the switch aft to the UP position moves the tab in the "nose up" direction. When the switch is released, it automatically returns to the center off position, and elevator trim tab motion stops. The disengage switch, labeled ELEC TRIM DISENGAGE, disables the system when placed in the DISENGAGE position.

A servo unit (which includes a motor and chain-driven, solenoid-operated clutch) actuates the trim tab to the selected position. When the clutch is not energized (trim switch off) the electric portion of the trim system freewheels so that manual operation is not affected. The electric trim system can be overridden at any time by manually rotating the elevator trim wheel, thus overriding the servo that drives the trim tab.

SECTION 2 LIMITATIONS

The following limitation applies to the electric elevator trim system:

1. The maximum altitude loss during an electric elevator trim malfunction may be as much as 200 feet.

SECTION 3 EMERGENCY PROCEDURES

1. Elevator Trim Disengage Switch -- DISENGAGE.
2. Manual Trim -- AS REQUIRED.

SECTION 4 NORMAL PROCEDURES

To operate the electric elevator trim system, proceed as follows:

1. Master Switch -- ON.
2. Elevator Trim Disengage Switch -- ON.
3. Trim Switch -- ACTUATE as desired.
4. Elevator Trim Position Indicator -- CHECK.

NOTE

To check the operation of the disengage switch, actuate the elevator trim switch with the disengage switch in the DISENGAGE position. Observe that the manual trim wheel and indicator do not rotate when the elevator trim switch is activated.

SECTION 5 PERFORMANCE

There is no change to the airplane performance when this trim system is installed.

SUPPLEMENT

GROUND SERVICE PLUG RECEPTACLE

SECTION 1 GENERAL

The ground service plug receptacle permits the use of an external power source for cold weather starting and lengthy maintenance work on the electrical and electronic equipment. The receptacle is located behind a small hinged door on the lower left side of the cowling.

NOTE

If no avionics equipment is to be used or worked on, the avionics power switch should be turned off. If maintenance is required on the avionics equipment, it is advisable to utilize a battery cart external power source to prevent damage to the avionics equipment by transient voltage. Do not crank or start the engine with the avionics power switch turned on.

The battery and external power circuits have been designed to completely eliminate the need to "jumper" across the battery contactor to close it for charging a completely "dead" battery. A special fused circuit in the external power system supplies the needed "jumper" across the contacts so that with a "dead" battery and an external power source applied, turning the master switch ON will close the battery contactor.

SECTION 2

LIMITATIONS

The following information must be presented in the form of a placard located on the inside of the ground service plug access door:

<p>CAUTION 24 VOLTS D.C. This aircraft is equipped with alternator and a negative ground system. OBSERVE PROPER POLARITY Reverse polarity will damage electrical components.</p>

SECTION 3

EMERGENCY PROCEDURES

There is no change to the airplane emergency procedures when the ground service plug receptacle is installed.

SECTION 4

NORMAL PROCEDURES

Just before connecting an external power source (generator type or battery cart), the avionics power switch should be turned off, and the master switch turned on.

WARNING

When turning on the master switch, using an external power source, or pulling the propeller through by hand, treat the propeller as if the ignition switch were on. Do not stand, nor allow anyone else to stand, within the arc of the propeller, since a loose or broken wire, or a component malfunction, could cause the propeller to rotate.

The ground service plug receptacle circuit incorporates a polarity reversal protection. Power from the external power source will flow only if the ground service plug is correctly connected to the airplane. If the plug is accidentally connected backwards, no power will flow to the electrical system, thereby preventing any damage to electrical equipment.

SECTION 5

PERFORMANCE

There is no change to the airplane performance when the ground service plug receptacle is installed.

SUPPLEMENT

OXYGEN SYSTEM

SECTION 1 GENERAL

A six-place oxygen system provides the supplementary oxygen necessary for continuous flight at high altitude. In this system, an oxygen cylinder, located in the fuselage tailcone, supplies the oxygen. Cylinder pressure is reduced to an operating pressure of 70 PSI by a pressure regulator attached to the cylinder. A shutoff valve is included as part of the regulator assembly. An oxygen cylinder filler valve is located on the left side of the fuselage tailcone (under a cover plate). Cylinder pressure is indicated by a pressure gage located in the overhead oxygen console above the pilot's and front passenger's seats.

Six oxygen outlets are provided; two in the overhead oxygen console and four in the cabin ceiling just above the side windows (one at each of the rear seating positions). One permanent, microphone-equipped mask is provided for the pilot, and five disposable type masks are provided for the passengers. All masks are the partial-rebreathing type, equipped with vinyl plastic hoses and flow indicators.

NOTE

The hose provided for the pilot is of a higher flow rate than those for the passengers; it is color-coded with an orange band adjacent to the plug-in fitting. The passenger hoses are color-coded with a green band. If the airplane owner prefers, he may provide higher flow hoses for all passengers. In any case, it is recommended that the pilot use the larger capacity hose. The pilot's mask is equipped with a microphone to facilitate use of the radio while using oxygen. An adapter cord is furnished with the microphone-equipped mask to mate the mask microphone lead to the auxiliary microphone jack located on the left side of the instrument panel. To connect the oxygen mask microphone, connect the mask lead to the adapter cord and plug the cord into the auxiliary microphone jack. (If an optional microphone-headset combination has been in use, the microphone lead from this equipment is already

plugged into the auxiliary microphone jack. It will be necessary to disconnect this lead from the auxiliary microphone jack so that the adapter cord from the oxygen mask microphone can be plugged into the jack.) A switch is incorporated on the left hand control wheel to operate the microphone.

A remote shutoff valve control, located adjacent to the pilot's oxygen outlet in the overhead oxygen console, is used to shut off the supply of oxygen to the system when not in use. The control is mechanically connected to the shutoff valve at the cylinder. With the exception of the shutoff function, the system is completely automatic and requires no manual regulation for change of altitude.

The oxygen cylinder, when fully charged, contains approximately 48 cubic feet of aviator's breathing oxygen (Spec. No. MIL-O-27210), under a pressure of 1800 PSI at 21°C (70°F). Filling pressures will vary, however, due to ambient temperature in the filling area, and the temperature rise resulting from compression of the oxygen. Because of this, merely filling to 1800 PSI will not result in a properly filled cylinder. Fill to pressures indicated in figure 1 for ambient temperature.

WARNING

Oil, grease or other lubricants in contact with oxygen create a serious fire hazard, and such contact must be avoided when handling oxygen equipment.

AMBIENT TEMPERATURE °F	FILLING PRESSURE PSIG	AMBIENT TEMPERATURE °F	FILLING PRESSURE PSIG
0	1600	50	1825
10	1650	60	1875
20	1700	70	1925
30	1725	80	1975
40	1775	90	2000

Figure 1. Oxygen Filling Pressures

OXYGEN DURATION CHART (48 CUBIC FEET CAPACITY)

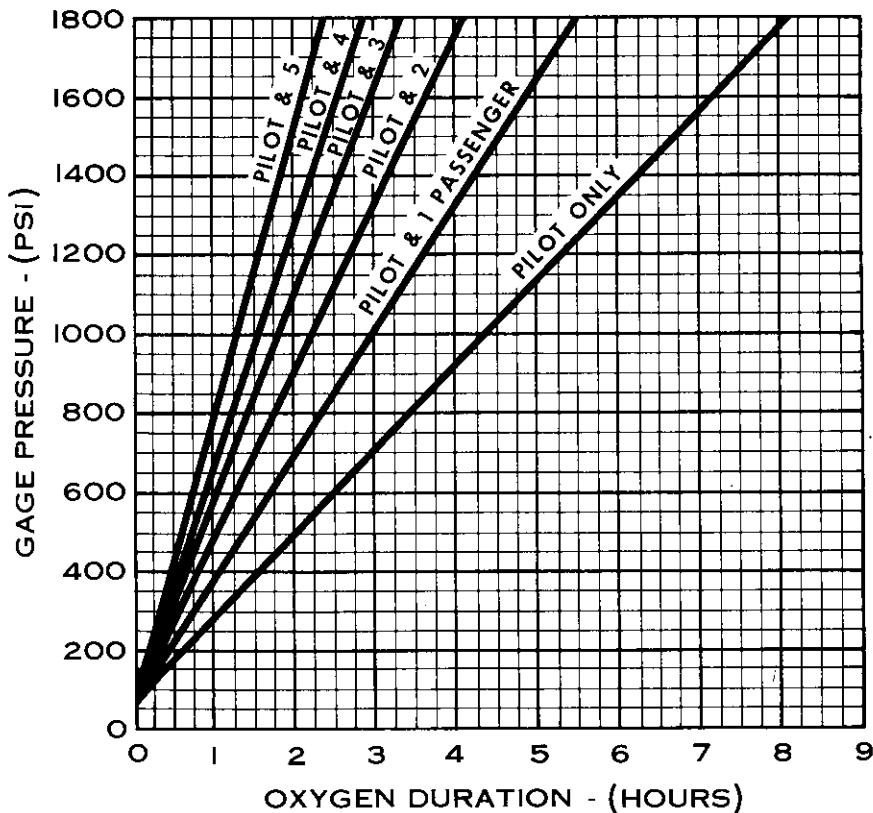

NOTE: This chart is based on a pilot with an orange color-coded oxygen line fitting and passengers with green color-coded line fittings.

Figure 2. Oxygen Duration Chart

For FAA requirements concerning supplemental oxygen, refer to FAR 91.32. Supplemental oxygen should be used by all occupants when cruising above 12,500 feet. As described in the Cessna booklet "Man At Altitude," it is often advisable to use oxygen at altitudes lower than 12,500 feet under conditions of night flying, fatigue, or periods of physiological or emotional disturbances. Also, the habitual and excessive use of tobacco or alcohol will usually necessitate the use of oxygen at less than 10,000 feet.

The Oxygen Duration Chart (figure 2) should be used in determining the usable duration (in hours) of the oxygen supply in your airplane. The following procedure outlines the method of finding the duration from the chart.

1. Note the available oxygen pressure shown on the pressure gage.
2. Locate this pressure on the scale on the left side of the chart, then go across the chart horizontally to the right until you intersect the line representing the number of persons making the flight. After intersecting the line, drop down vertically to the bottom of the chart and read the duration in hours given on the scale.
3. As an example of the above procedure, 1400 PSI of pressure will safely sustain the pilot only for nearly 6 hours and 15 minutes. The same pressure will sustain the pilot and three passengers for approximately 2 hours and 30 minutes.

NOTE

The Oxygen Duration Chart is based on a standard configuration oxygen system having one orange color-coded hose assembly for the pilot and green color-coded hoses for the passengers. If orange color-coded hoses are provided for pilot and passengers, it will be necessary to compute new oxygen duration figures due to the greater consumption of oxygen with these hoses. This is accomplished by computing the total duration available to the pilot only (from PILOT ONLY line on chart), then dividing this duration by the number of persons (pilot and passengers) using oxygen.

SECTION 2 LIMITATIONS

There is no change to the airplane limitations when oxygen equipment is installed.

SECTION 3 EMERGENCY PROCEDURES

There is no change to the airplane emergency procedures when oxygen equipment is installed.

SECTION 4 NORMAL PROCEDURES

Prior to flight, check to be sure that there is an adequate oxygen supply for the trip, by noting the oxygen pressure gage reading, and referring to the Oxygen Duration Chart (figure 2). Also, check that the face masks and hoses are accessible and in good condition.

WARNING

For safety reasons, no smoking should be allowed in the airplane while oxygen is being used.

When ready to use the oxygen system, proceed as follows:

1. Mask and Hose -- SELECT. Adjust mask to face and adjust metallic nose strap for snug mask fit.
2. Delivery Hose -- PLUG INTO OUTLET nearest to the seat you are occupying.

NOTE

When the oxygen system is turned on, oxygen will flow continuously at the proper rate of flow for any altitude without any manual adjustments.

3. Oxygen Supply Control Knob -- ON.
4. Face Mask Hose Flow Indicator -- CHECK. Oxygen is flowing if the indicator is being forced toward the mask.
5. Delivery Hose -- UNPLUG from outlet when discontinuing use of oxygen. This automatically stops the flow of oxygen.
6. Oxygen Supply Control Knob -- OFF when oxygen is no longer required.

SECTION 5 PERFORMANCE

There is no change to the airplane performance when oxygen equipment is installed.

SUPPLEMENT

PROPELLER ANTI-ICE SYSTEM

SECTION 1 GENERAL

The propeller anti-ice system provides a measure of protection if unexpected icing conditions are encountered. The system is operated by a rocker switch located on a special icing equipment switch panel on the upper left corner of the instrument panel. When the switch is placed in the ON position, current flows to an anti-ice timer which supplies electric power in cycles every 20 seconds to elements in the anti-icing boots located on the propeller blades. Operation of the anti-ice system can be checked by monitoring a propeller anti-ice ammeter near the upper right corner of the instrument panel. The system is protected by a 20-amp circuit breaker, labeled PROP A-ICE, located on the left switch and control panel.

SECTION 2 LIMITATIONS

There is no change to the airplane limitations when the propeller anti-ice system is installed; intentional flight into known icing conditions is prohibited, regardless of installed ice protection equipment.

SECTION 3 EMERGENCY PROCEDURES

There is no change to the airplane emergency procedures when the propeller anti-ice system is installed.

SECTION 4

NORMAL PROCEDURES

Flight into known icing conditions is prohibited. If unexpected icing conditions are encountered, the following procedure is recommended:

1. Master Switch -- ON.
2. Propeller Anti-Ice Switch -- ON.
3. Propeller Anti-Ice Ammeter -- CHECK in green arc range (14 to 18 amps).

NOTE

To check the heating elements and anti-ice timer for one complete cycle, the system must be left on for approximately 1 minute. Ammeter readings must remain in the green arc except during momentary change.

NOTE

While using the anti-ice system, monitor the airplane ammeter to ensure that the electrical system does not become overloaded. If the total electrical load is high, resulting in a discharge indication, limit the use of other electrical equipment so that the airplane ammeter maintains a slight charge.

CAUTION

If the ammeter indicates unusually high or low amperage during the 20-second cycle of operation, a malfunction has occurred and it is imperative that the system be turned off. Uneven anti-icing may result, causing propeller unbalance and engine roughness.

NOTE

For accurate magnetic compass readings, turn the pitot heat, propeller anti-ice and windshield anti-ice switches OFF momentarily.

4. Propeller Anti-Ice Switch -- OFF when anti-icing is no longer required.

SECTION 5

PERFORMANCE

There is no change to the airplane performance when the propeller anti-ice system is installed.

SUPPLEMENT

SKYDIVING KIT

SECTION 1 GENERAL

The skydiving kit is designed to improve passenger comfort and facilitate diver-to-pilot communications during skydiving operations. The kit consists of a spoiler, skydiver steering switch, and a steering signal light console. The spoiler is installed on the door hinges of the removed front cargo door to minimize the strong air flow buffeting within the cabin when the cargo doors are removed. The rocker-type steering switch is mounted inside the cabin on the upper sill of the cargo door opening and is used by the skydiver to signal the pilot of his desired flight path over the drop zone. A steering signal light console, with red and green lights controlled by operation of the steering switch, is mounted on top of the instrument panel. Illumination of the red light indicates to the pilot that the diver desires that the airplane be steered left; conversely, a green light shows that the pilot is to steer right.

SECTION 2 LIMITATIONS

Removal of the cargo doors requires that a spoiler be installed. With the doors removed and the spoiler installed, the following placard must be displayed on the instrument panel:

With cargo doors removed
do not exceed 130 KTS IAS.

SECTION 3

EMERGENCY PROCEDURES

There is no change to the airplane emergency procedures when the skydiving kit is installed.

SECTION 4

NORMAL PROCEDURES

For skydiving operations, removal of both cargo doors is suggested, since exit through a single door would be difficult with the spoiler obstructing part of the door opening. Installation of the spoiler substantially reduces air flow buffeting in the cabin; however, all loose equipment, including head rests, rear window sun shade, removable arm rests, safety belts, etc., should be removed or secured. Fifth and sixth seat passengers will receive a strong air blast, and face protection in the form of goggles and helmet is recommended.

Removal of the cargo doors also necessitates the installation of a depressor plate over the wing flap circuit interrupt switch to permit flap operation with doors removed. (Under normal operations with the cargo doors installed, the switch prevents flap operation whenever the front cargo door is open to prevent accidental damage to the door or wing flap if the flaps are lowered.)

With the cargo doors removed, flight characteristics are essentially unchanged, except that slightly different directional trim may be needed.

Seating accommodations for as many as five skydivers are more easily provided by removing the right center seat and the copilot seat, and allowing these divers to sit on the floor back-to-back. An extra long seat belt (attached to the copilot seat belt anchor points) is needed to restrain the rearward facing diver having a back-pack parachute.

SECTION 5

PERFORMANCE

Airplane performance information provided in this handbook does not apply when the airplane is flown with the cargo doors removed since significant performance decrements result. For example, maximum rate of climb is reduced by approximately 100 fpm and cruise speed is reduced by approximately 10 knots.

SUPPLEMENT

STROBE LIGHT SYSTEM

SECTION 1 GENERAL

The high intensity strobe light system enhances anti-collision protection for the airplane. The system consists of two wing tip-mounted strobe lights (with integral power supplies), a two-position rocker switch labeled STROBE LIGHTS on the left switch and control panel, and a 5-ampere push-to-reset circuit breaker, also located on the left switch and control panel.

SECTION 2 LIMITATIONS

Strobe lights must be turned off when taxiing in the vicinity of other airplanes, or during night flight through clouds, fog or haze.

SECTION 3 EMERGENCY PROCEDURES

There is no change to the airplane emergency procedures when strobe lights are installed.

SECTION 4 NORMAL PROCEDURES

To operate the strobe light system, proceed as follows:

1. Master Switch -- ON.
2. Strobe Light Switch -- ON.

SECTION 5 PERFORMANCE

The installation of strobe lights will result in a minor reduction in cruise performance.

SUPPLEMENT

WINDSHIELD ANTI-ICE SYSTEM

SECTION 1 GENERAL

The windshield anti-ice system assures adequate visibility for a landing during flight conditions where ice may form on the windshield. A detachable electrically-heated glass panel, 11.0 inches high by 5.5 inches wide, mounts to the base of the windshield in front of the pilot. Quick disconnects are provided to facilitate ease of installation and removal. When not in use, a padded cover is provided for protection against scratches, breakage, and wiring damage, and the panel may be stowed in the seat pocket on the aft side of the pilot's or co-pilot's seat back. Windshield anti-icing is controlled by a rocker-type switch, labeled W/S A/ICE, located on a special icing equipment switch panel near the upper left corner of the instrument panel. The system is protected by a 5-ampere, push-to-reset circuit breaker, labeled W/S A/ICE, located on the left switch and control panel.

The heated glass panel should be installed whenever icing conditions are a possibility on a proposed flight, especially if the freezing level is near or at the surface.

SECTION 2 LIMITATIONS

This is no change to the airplane limitations when the windshield anti-ice system is installed; intentional flight into known icing conditions is prohibited regardless of installed ice protection equipment. Prolonged operation of the system without the engine running should be avoided.

SECTION 3 EMERGENCY PROCEDURES

There is no change to the airplane emergency procedures when the windshield anti-ice system is installed.

SECTION 4

NORMAL PROCEDURES

The anti-ice system should be checked, **prior to engine start**, as follows:

1. Anti-Ice Panel -- INSTALL.
2. Master Switch -- ON.
3. Windshield Anti-Ice Switch -- ON for one minute.
4. Anti-Ice Panel -- CHECK FOR WARMTH (step outside the airplane to feel for warmth in the panel).
5. Windshield Anti-Ice and Master Switches -- OFF.

CAUTION

Inadvertent prolonged operation of the heated anti-icing panel without the engine running may cause damage to the panel and crazing of the windshield.

Flight into known icing conditions is prohibited. If unexpected icing conditions are encountered, the following procedure is recommended:

1. Windshield Anti-Ice Switch -- ON 5 to 10 minutes in advance of its need. The anti-ice system may become ineffective if a large accumulation of ice is allowed to form.

NOTE

For accurate magnetic compass readings, turn the pitot heat, propeller anti-ice and windshield anti-ice switches OFF momentarily.

2. Windshield Anti-Ice Switch -- OFF when the possibility of icing no longer exists.

SECTION 5

PERFORMANCE

There is no change to the airplane performance when the windshield anti-ice system is installed.

SUPPLEMENT

WINTERIZATION KIT

SECTION 1 GENERAL

The winterization kit consists of two cover plates (with placards) to partially cover the cowl nose cap opening, and insulation for the engine crankcase breather line, and a placard to be installed on the upper right side of the instrument panel. This equipment should be installed for operations in temperatures consistently below 20°F (-7°C). Once installed, the crankcase breather insulation is approved for permanent use, regardless of temperature.

SECTION 2 LIMITATIONS

The following information must be presented in the form of placards when the airplane is equipped with a winterization kit.

1. On each cover plate:

REMOVE WHEN
OAT EXCEEDS 20°F

2. On the upper right side of the instrument panel:

WINTERIZATION KIT MUST BE REMOVED
WHEN OUTSIDE AIR TEMPERATURE IS
ABOVE 20°F.

SECTION 3 EMERGENCY PROCEDURES

There is no change to the airplane emergency procedures when the winterization kit is installed.

SECTION 4 NORMAL PROCEDURES

There is no change to the airplane normal procedures when the winterization kit is installed.

SECTION 5 PERFORMANCE

There is no change to the airplane performance when the winterization kit is installed.

SUPPLEMENT

AM/FM CASSETTE STEREO ENTERTAINMENT CENTER

(Type EC-100)

SECTION 1 GENERAL

The EC-100 Cassette Stereo Player and AM/FM Radio is a compact, fully automatic AM/FM Mpx radio and stereo cassette player mounted in the instrument panel above the glove box, or in the alternate location utilizing the glove box. In addition to the player/radio, the system consists of stereo headphones and an externally mounted, fixed-wire antenna. All operating controls for the player/radio and headphones are shown and described in figure 1.

The AM/FM Mpx Radio will receive AM frequencies between 525 and 1650 kHz or FM frequencies between 88 and 108 MHz. AM or FM reception is selected by an AM/FM pushbutton located on the front of the set and with strong FM stations, at altitude, the radio can receive FM stations for over 200 miles.

The cassette stereo player is equipped with four-track, two-channel stereo cassette type playback with a tape speed of 4.76 cm/sec. Any standard-size monaural or stereo cassette may be used in the player. Cassettes are automatically activated when inserted in cassette receptacle (with tape play side to the right) with radio ON and AM/FM switch in either AM or FM position. When cassette is removed, radio play will automatically resume. Annunciator lights will illuminate monitoring the STEREO, TAPE, or COM Interrupt modes.

A COM Interrupt mode in this system, when activated, will interrupt stereo and cassette audio to provide selected aircraft radio audio to the stereo headphones. After a short delay, preselected stereo or cassette play will return following the completion of the aircraft communications.

A COM ONLY mode in the EC-100, allows the pilot to eliminate all entertainment modes and activate uninterrupted navigation and communications audio.

Headphones are equipped with individual earphone volume controls and a phone plug which must be attached to one of the phone jacks mounted overhead. Stereo phone jacks are placarded either "STEREO" or "STEREO HEADPHONE".

NOTICE

Sound from the player/radio is only available through stereo headphones.

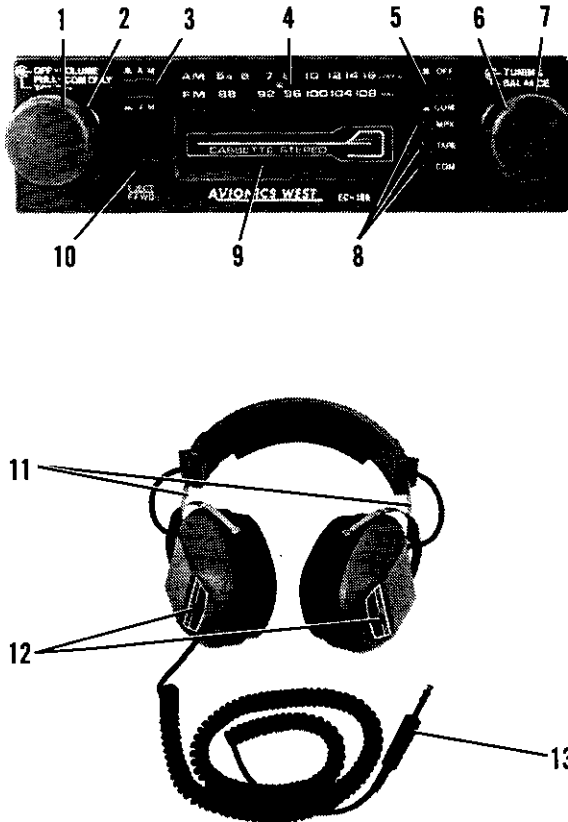

Figure 1. AM/FM Cassette Stereo Entertainment Center, Operating Controls. (Sheet 1 of 3)

1. OFF/VOLUME AND PULL-COM ONLY CONTROL KNOB:

OFF-VOLUME CONTROL - Turning knob fully counterclockwise to detent turns off entire system. Advancing the knob clockwise passed the detent, applies power to the unit. Advancing it further clockwise increases the volume of audio level.

NOTE

This control affects the audio level of both the radio/tape system as well as the communications audio.

PULL-COM ONLY - Pull out on this knob to eliminate all entertainment modes and enable the NAV/COM input only.

2. RADIO/PLAYER AND COM TONE CONTROL (TONE) - Normal position of this control is fully clockwise for flat audio response. If excessive high frequency hiss is evident in the headphones, the control may be rotated counterclockwise to reduce the high frequency response.
3. AM/FM PUSHBUTTON SELECTOR SWITCH (AM/FM) - Selects AM or FM radio reception; IN for FM and OUT for AM.
4. AM and FM RADIO FREQUENCY INDICATOR DIAL (AM/FM) - Indicates selected operating radio frequencies for AM between 525 and 1650 kHz and FM between 88 and 108 MHz.
5. COM INTERRUPT PUSHBUTTON SELECTOR SWITCH (OFF/COM) - To activate the communications override feature, pushbutton is pushed in. Communications override is eliminated by pushing button completely in and releasing (button out).
6. TUNING SELECTOR CONTROL KNOB (TUNING) - Rotate to tune in desired AM or FM operating frequencies.
7. RADIO/PLAYER AND COM SPEAKER BALANCE CONTROL KNOB (BALANCE) - Left and right speaker balance is controlled by counterclockwise and clockwise rotation of control knob.
8. MODE ANNUNCIATOR LIGHTS:
 - MPX (GREEN) - Illuminates green to indicate that a stereo FM station has been tuned-in.
 - TAPE (AMBER):
 - Dim Position - Illuminates dim amber to indicate tape mode of operation.
 - Bright Position - Illuminates bright amber to indicate cassette has reached end of tape and requires changing.
 - COM (RED) - Illuminates red to indicate com mode has been activated and a com transmission is being received.
9. CASSETTE RECEPTACLE - Insert cassette cartridge, turned sideways, with tape play side to the right. When the cartridge is inserted far enough, the mechanism will snap it into place and the EJECT pushbutton will move to the extended

Figure 1. AM/FM Cassette Stereo Entertainment Center, Operating Controls. (Sheet 2 of 3)

position (button out). Top numbered side will play. Either monaural or standard stereo cassettes may be used.

10. TAPE EJECT AND FAST FORWARD PUSHBUTTON (EJECT/F. FWD) - This pushbutton has two modes of control. For fast forward (rewind), pushbutton is pushed in slightly. Cassette is ejected when button is pushed completely in.
11. HEADPHONE EXTENSION-ADJUSTMENT ARMS - Located on both sides of the headphones. Earphone extension is adjusted by sliding the adjustment arms in, or out, of the head pad to a comfortable listening position.
12. EARPHONE VOLUME CONTROL LEVERS - Regulates volume of audio to individual earphones. Volume increases as levers are moved to higher settings.
13. HEADPHONE PLUG - Inserts into one of the phone jacks located overhead and placarded "STEREO" or "STEREO HEADPHONE". Jacks are for 1/4-inch stereo plugs only.

CAUTION

To prevent damage to the entertainment center, use only 8-ohm headphones with 1/4-inch stereo type plugs.

Figure 1. AM/FM Cassette Stereo Entertainment Center, Operating Controls. (Sheet 3 of 3)

SECTION 2 LIMITATIONS

There is no change to the airplane limitations when this avionics equipment is installed.

SECTION 3 EMERGENCY PROCEDURES

There is no change to the airplane emergency procedures when this avionics equipment is installed.

SECTION 4 NORMAL PROCEDURES

AM/FM RADIO OPERATIONS:

1. Headphones -- INSERT headphone plug(s) into jack(s) mounted

- overhead and placarded either "STEREO" or "STEREO HEADPHONE".
2. Earphone Volume Control Levers -- SELECT a position slightly lower than medium volume for both volume control levers on the headphones.
 3. Headphone Extension-Adjustment Arms -- ADJUST to comfortable listening position.
 4. OFF/VOLUME AND PULL-COM ONLY CONTROL KNOB -- ROTATE control knob clockwise past detent to activate unit. Continue to rotate knob clockwise to desired volume setting.

NOTE

Audio can only be heard through stereo headphones.

CAUTION

The stall and gear warning horn may not be heard with the stereo headphones in use.

With headphones plugged in, extended play at full volume should be avoided in order to prevent damage to headphones and hearing.

5. AM/FM Pushbutton Selector Switch -- SELECT as desired; IN for FM, OUT for AM.
6. TUNING Knob -- SELECT desired frequency.
7. MPX Stereo Annunciator Light -- CHECK ON (green light will illuminate) if FM radio station reception is selected.
8. Earphone Volume Control Levers -- ADJUST to desired audio setting. Volume is increased by moving levers to HI settings, and lowered by moving levers to LO settings.

NOTE

Improper tuning will result in poor tone and excessive noise.

9. TONE Control -- ROTATE to a fully clockwise position for normal operation.

NOTE

If excessive high frequency hiss is evident in the head-

phones, the control may be rotated counterclockwise to reduce the high frequency response.

10. **BALANCE Control** -- ADJUST to desired audio setting.

CASSETTE PLAYER OPERATIONS:

1. **Tape Receptacle** -- INSERT CASSETTE with tape play side to right and adjust listening controls on unit and headphones. Player will play top numbered side.

NOTE

When tape is ejected, radio play will automatically resume.

2. **TAPE Annunciator Light** -- CHECK ON; Light will illuminate dim amber when cassette is installed and will illuminate bright amber when cassette has reached end of tape play and requires changing.

CAUTION

To insure the best performance and operation of your cassette player, follow these simple rules:

- a. Loose cassette tape should not be played. If your tape is loose, rewind it before playing.
 - b. Do not keep cassette tape in your player long after cassette play is finished.
 - c. Do not use non-standard cassette tapes. Damage to your player will result.
3. **Tape EJECT/Fast Forward Pushbutton:**
 - a. To Eject Tape -- PUSH IN button all the way to eject cassette at end of play or at any point desired.
 - b. To Select Fast Forward (Rewind) -- PUSH SLIGHTLY in for fast forward position (push button in approximately half way).
 - c. To Cancel Fast Forward -- RELEASE BUTTON.

COM INTERRUPT OPERATIONS:

NOTE

Aircraft radio(s) must be turned on and the desired audio, to be monitored by COM Interrupt, must have the associated receiver's SPEAKER/PHONE selector switch(es) placed in the PHONE position on the audio control panel in order for the COM Interrupt feature to be operational. Audio signals that the pilot does not want to monitor, by the COM Interrupt feature, must have their associated receiver's SPEAKER/PHONE selector switch(es) on the audio control panel placed in the OFF position.

1. AM/FM Radio/Cassette Player -- SELECT and TURN ON desired system to be operated.
2. VOL Control -- SET to desired listening level.

NOTES

This control affects the stereo headphone audio level of the radio/tape system and other aircraft radios selected.

If the audio level from the Nav/Com Radio is too weak getting to the entertainment center, the COM Interrupt circuit will not be activated. If the audio level is too strong, distortion will be produced in the audio signal.

3. Com Interrupt Pushbutton Selector Switch (on EC-100) -- PUSH button in halfway and release to activate COM Interrupt circuit.
4. Aircraft's COM Radio SQ Control -- ROTATE clockwise until background noise is noticable and note that the red (COM) annunciator illuminates on the EC-100 to verify COM Interrupt operation, and then, backoff slightly on the SQ Control until background noise disappears. Repeat this operation periodically in normal flight.

COM ONLY OPERATIONS:

1. PULL-COM ONLY Selector Knob -- PULL knob out to override all audio modes in the EC-100 and activate audio signals as selected by the PHONE switches on the audio control panel.
2. COM Annunciator Light -- CHECK ON (Red) when selected audio is being received.

SECTION 5

PERFORMANCE

There is no change to the airplanes performance when this avionics equipment is installed. However, the installation of an externally mounted antenna or several related external antennas will result in a minor reduction in cruise performance.

SUPPLEMENT

DME

(TYPE 190)

SECTION 1

GENERAL

The DME 190 (Distance Measuring Equipment) system consists of a panel mounted 200 channel UHF transmitter-receiver and an externally mounted antenna. The transceiver has a single selector knob that changes the DME's mode of operation to provide the pilot with: distance-to-station, time-to-station, or ground speed readouts. The DME is designed to operate at altitudes up to a maximum of 50,000 feet at ground speeds up to 250 knots and has a maximum slant range of 199.9 nautical miles.

The DME can be channeled independently or by a remote NAV set. When coupled with a remote NAV set, the MHz digits will be covered over by a remote (REM) flag and the DME will utilize the frequency set by the NAV set's channeling knobs. When the DME is not coupled with a remote NAV set, the DME will reflect the channel selected on the DME unit. The transmitter operates in the frequency range of 1041 to 1150 MHz and is paired with 108 to 117.95 MHz to provide automatic DME channeling. The receiver operates in the frequency range of 978 to 1213 MHz and is paired with 108 to 117.95 MHz to provide automatic DME channeling.

All operating controls (except for a SPEAKER/PHONE selector switch mounted on the audio control panel supplied with one or two transmitters as described in Section 7) for the DME are mounted on the front panel of the DME and are described in Figure 1.

SECTION 2

LIMITATIONS

There is no change to the airplane limitations when this avionic equipment is installed.

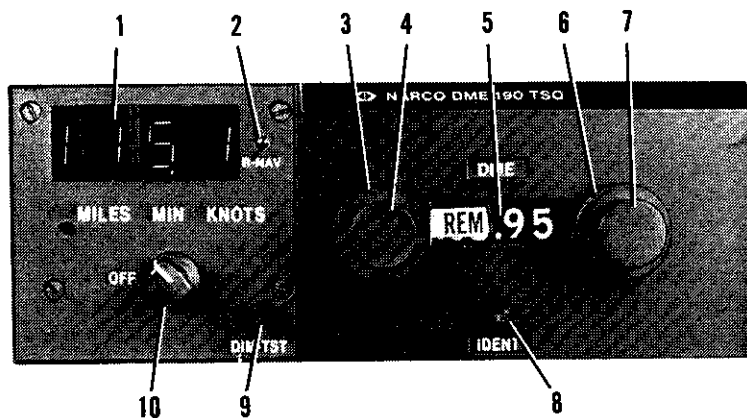

1. READOUT WINDOW - Displays function readout in nautical miles (distance-to-station), minutes (time-to-station) or knots (ground speed).
2. R-NAV INDICATOR LAMP - The green R-NAV indicator lamp is provided to indicate the DME is coupled to an R-NAV system. Since this DME is not factory installed with an R-NAV system on Cessna airplanes, the R-NAV indicator lamp should never be illuminated. However, if an R-NAV system is coupled to the DME, and when in R-NAV mode, the R-NAV lamp will light which indicates that the distance readout is the "way point" instead of the DME station. The DME can only give distance (MILES) in R-Nav mode.
3. REMOTE CHANNELING SELECTOR - Two position selector. In the first position, the DME will utilize the frequency set by the DME channeling knobs. In the second position, the MHz digits will utilize the frequency set by the NAV 1 unit's channeling knobs.
4. WHOLE MEGAHERTZ SELECTOR KNOB - Selects operating frequency in 1-MHz steps between 108 and 117 MHz.
5. FREQUENCY INDICATOR - Shows operating frequency selected on the DME or displays remote (REM) flag to indicate DME is operating on a frequency selected by the remote NAV 1 receiver.
6. FRACTIONAL MEGAHERTZ SELECTOR KNOB - Selects operating frequency in 50 kHz steps. This knob has two positions, one for the 0 and one for the 5.
7. FRACTIONAL MEGAHERTZ SELECTOR KNOB - Selects operating frequency in tenths of a Megahertz (0-9).

Figure 1. DME 190 Operating Controls (Sheet 1 of 2)

8. IDENT KNOB - Rotation of this control increases or decreases the volume of the received station's Ident signal. An erratic display, accompanied by the presence of two Ident signals, can result if the airplane is flying in an area where two stations using the same frequency are transmitting.
9. DIM - TST KNOB -
 - DIM: Controls the brilliance of the readout lamp's segments. Rotate the control as desired for proper lamp illumination in the function window (The frequency window is dimmed by the aircraft's radio light dimming control).
 - TST (PUSH TEST): This control is used to test the illumination of the readout lamps, with or without being tuned to a station. Press the control, a readout of 188.8 should be seen with the mode selector switch in the MIN or KNOTS position. The decimal point along with 188.8 will light in the MILES mode. When the control is released, and had the DME been channeled to a nearby station, the distance to that station will appear. If the station channeled was not in range, a "bar" readout will be seen (--.- or --.-).
10. MODE SELECTOR SWITCH -
 - OFF: Turns the DME OFF.
 - MILES: Allows a digital readout to appear in the window which represents slant range (in nautical miles) to or from the channeled station.
 - MIN: Allows a digital readout (in minutes) to appear in the window that it will take the airplane to travel the distance to the channeled station. This time is only accurate when flying directly TO the station and after the ground speed has stabilized.
 - KNOTS: Allows a digital readout (in knots) to appear in the window that is ground speed and is valid only after the stabilization time (approximately 2 minutes) has elapsed when flying directly TO or FROM the channeled station.

Figure 1. DME 190 Operating Controls (Sheet 2 of 2)

SECTION 3 EMERGENCY PROCEDURES

There is no change to the airplane emergency procedures when this avionic equipment is installed.

SECTION 4 NORMAL PROCEDURES

TO OPERATE:

1. Mode Selector Switch -- SELECT desired DME function.
2. Frequency Selector Knobs -- SELECT desired frequency and allow equipment to warm-up at least 2 minutes.

NOTE

If remote channeling selector is set in REM position, select the desired frequency on the #1 Nav radio.

3. PUSH TEST Control -- PUSH and observe reading of 188.8 in function window.
4. DIM Control -- ADJUST.
5. DME SPEAKER/PHONE Selector Switch (on audio control panel) -- SELECT as desired.
6. IDENT CONTROL -- ADJUST audio output in speaker or headset.
7. Mode Selector Functions:
 - MILES Position -- Distance-to-Station is slant range in nautical miles.
 - MIN Position -- Time-to-Station when flying directly to station.
 - KNOTS Position -- Ground Speed in knots when flying directly to or from station.

CAUTION

After the DME 190 has been turned OFF, do not turn it on again for 5 seconds to allow the protective circuits to reset.

SECTION 5 PERFORMANCE

There is no change to the airplane performance when this avionic equipment is installed. However, the installation of an externally mounted antenna or several related external antennas, will result in a minor reduction in cruise performance.

SUPPLEMENT

EMERGENCY LOCATOR TRANSMITTER (ELT)

SECTION 1 GENERAL

The ELT consists of a self-contained dual-frequency radio transmitter and battery power supply, and is activated by an impact of 5g or more as may be experienced in a crash landing. The ELT emits an omni-directional signal on the international distress frequencies of 121.5 and 243.0 MHz. (Some ELT units in export aircraft transmit only on 121.5 MHz.) General aviation and commercial aircraft, the FAA, and CAP monitor 121.5 MHz, and 243.0 MHz is monitored by the military. Following a crash landing, the ELT will provide line-of-sight transmission up to 100 miles at 10,000 feet. The ELT supplied in domestic aircraft transmits on both distress frequencies simultaneously at 75 mw rated power output for 50 continuous hours in the temperature range of -4°F to +131°F (-20°C to +55°C). The ELT unit in export aircraft transmits on 121.5 MHz at 25 mw rated power output for 50 continuous hours in the temperature range of -4°F to +131°F (-20°C to +55°C).

The ELT is readily identified as a bright orange unit mounted behind the baggage compartment wall in the tailcone. To gain access to the unit, remove the baggage compartment wall. The ELT is operated by a control panel at the forward facing end of the unit (see figure 1).

SECTION 2 LIMITATIONS

The following information is presented in the form of a placard located on the baggage compartment wall.

EMERGENCY LOCATOR TRANSMITTER
INSTALLED AFT OF THIS PARTITION.
MUST BE SERVICED IN ACCORDANCE
WITH FAR PART 91.52

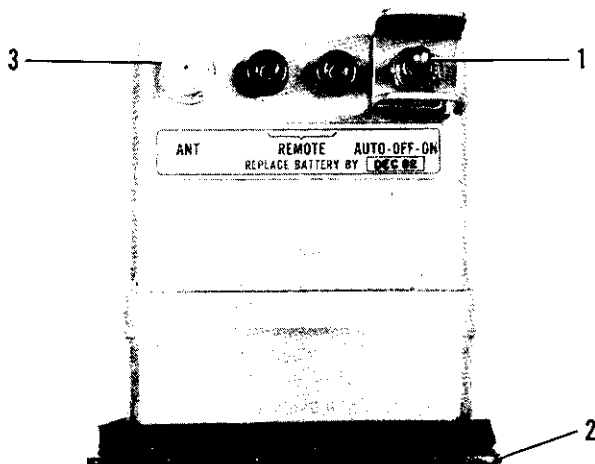

1. FUNCTION SELECTOR SWITCH (3-position toggle switch):
 - ON - Activates transmitter instantly. Used for test purposes and if "g" switch is inoperative.
 - OFF - Deactivates transmitter. Used during shipping, storage and following rescue.
 - AUTO - Activates transmitter only when "g" switch receives 5g or more impact.
2. COVER - Removable for access to battery pack.
3. ANTENNA RECEPTACLE - Connects to antenna mounted on top of tailcone.

Figure 1. ELT Control Panel

SECTION 3 EMERGENCY PROCEDURES

Immediately after a forced landing where emergency assistance is required, the ELT should be utilized as follows.

1. ENSURE ELT ACTIVATION --Turn a radio transceiver ON and select 121.5 MHz. If the ELT can be heard transmitting, it was activated by the "g" switch and is functioning properly. If no emergency tone is audible, gain access to the ELT and place the function selector switch in the ON position.

2. PRIOR TO SIGHTING RESCUE AIRCRAFT -- Conserve airplane battery. Do not activate radio transceiver.
3. AFTER SIGHTING RESCUE AIRCRAFT -- Place ELT function selector switch in the OFF position, preventing radio interference. Attempt contact with rescue aircraft with the radio transceiver set to a frequency of 121.5 MHz. If no contact is established, return the function selector switch to ON immediately.
4. FOLLOWING RESCUE -- Place ELT function selector switch in the OFF position, terminating emergency transmissions.

SECTION 4

NORMAL PROCEDURES

As long as the function selector switch remains in the AUTO position, the ELT automatically activates following an impact of 5g or more over a short period of time.

Following a lightning strike, or an exceptionally hard landing, the ELT may activate although no emergency exists. To check your ELT for inadvertent activation, select 121.5 MHz on your radio transceiver and listen for an emergency tone transmission. If the ELT can be heard transmitting, place the function selector switch in the OFF position and the tone should cease. Immediately place the function selector switch in the AUTO position to re-set the ELT for normal operation.

SECTION 5

PERFORMANCE

There is no change to the airplane performance data when this equipment is installed.

SUPPLEMENT

FOSTER AREA NAVIGATION SYSTEM (Type 511)

SECTION 1 GENERAL

The Foster Area Navigation System (RNAV - Type 511) consists of a 511 Area Nav Computer, a compatible VHF navigation receiver, a DME Adapter Module and DME.

The RNAV 511 is a basic Area Navigation Computer with two thumb-wheel programmable waypoints. It performs continuous computation of triangulation problems.

The VOR and DME equipment in the aircraft provides information to the computer on aircraft position relative to the VORTAC station. A waypoint is dialed into one set of waypoint thumbwheels by inserting the RADIAL and DISTANCE of the waypoint (the position the pilot would like to fly over, or to) relative to the VORTAC station. The RNAV 511 computer calculates the Magnetic Bearing (BEARING) and Distance (RANGE NM) from the aircraft to the waypoint repeatedly to provide continual information on WHICH WAY and HOW FAR to the waypoint.

The pilot can monitor BEARING and RANGE on RNAV 511 to fly straight line paths to waypoints up to 200 NM distance from the aircraft position. Waypoints can be precisely dialed into the thumbwheels to 0.1° and 0.1 NM resolution.

The RNAV 511 also provides immediate position orientation relative to the VORTAC (VOR/DME) station being used for computation. Merely press the VOR/DME pushbutton to display the RADIAL and DME distance from the VORTAC.

Another feature of the RNAV 511 is its ability to provide evidence of proper computation in the system. The system can be tested at anytime before flight or while airborne to confirm proper computer operation. An acceptable "test" is evidenced by the active waypoint's RADIAL/DISTANCE being displayed in the BEARING and RANGE windows of the RNAV 511 while TEST pushbutton is pressed. In addition to the "test" feature, diagnostic functions are provided to alert the pilot of why the system is not functional.

SECTION 2

LIMITATIONS

This RNAV installation is not approved for IFR operations and the following information is displayed on individual placards:

1. Adjacent to panel unit when used with the DME 190:

RNAV FOR VFR FLIGHT ONLY
TUNE DME & NAV 1 TO SAME
VORTAC FOR RNAV OPERATION

2. Adjacent to panel unit when used with the 400 DME:

RNAV FOR VFR FLIGHT ONLY
DME MODE SELECTOR ON
NAV 1 OR NAV 2 ONLY

SECTION 3

EMERGENCY PROCEDURES

There is no change to the airplane emergency procedures when this avionic equipment is installed.

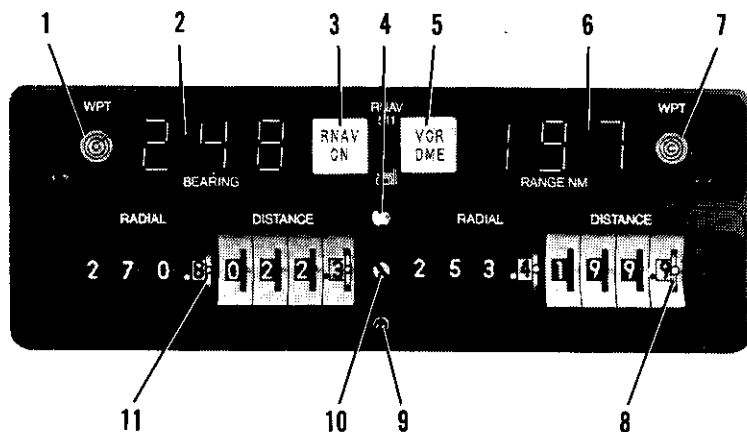

1. WAYPOINT PUSHBUTTON (WPT) - Activates the waypoint data dialed into the left side thumbwheels (11). When pressed, the WPT pushbutton lights to indicate which waypoint is "active". The WPT pushbutton light intensity is controlled by a photocell (4).
2. MAGNETIC BEARING DISPLAY READOUT - Digitally displays the magnetic bearing from the airplane to the waypoint. While VOR/DME pushbutton (5) is pressed, the digital display reads RADIAL from the VOR station on which the airplane is presently positioned.
3. RNAV ON/OFF PUSHBUTTON (RNAV ON) - When pressed, RNAV ON light will illuminate and set is turned ON. When pressed again, set will be turned OFF and the RNAV ON light will go out. The pushbutton lighting is automatically dimmed by the photocell (4).
4. PHOTOCELL - Senses ambient cockpit light and controls brightness of pushbuttons (1, 3, 5 & 7) and digital displays (2 & 6).
5. VOR DME PUSHBUTTON - Provides PRESENT POSITION information as to VOR RADIAL and DME DISTANCE digitally in positions (2) and (6) respectively when the pushbutton is pressed.
6. DISTANCE DISPLAY READOUT - Digitally displays airplane DISTANCE TO or FROM the waypoint. Reads by 0.1 NM increments up to 99.9 NM and by 1.0 NM increments over 100 NM. Maximum range readout is 199 NM. While VOR/DME pushbutton (5) is pressed, the digital display reads DME distance to the VORTAC station from the airplane.

Figure 1. Foster Area Nav (Type 511) Computer Operating Controls and Indicators (Sheet 1 of 2)

7. **WAYPOINT PUSHBUTTON (WPT)** - Activates the waypoint data dialed into the RIGHT side thumbwheels (8). When pressed, the WPT pushbutton lights to indicate which waypoint is "active". The WPT pushbutton light intensity is controlled by photocell (4).
8. **RADIAL AND DISTANCE THUMBWHEELS** - Waypoint location (RADIAL and DISTANCE) is dialed into thumbwheels to 0.1° and 0.1 NM resolution. Maximum waypoint offset from the VORTAC is 199.9 NM.
9. **TEST PUSHBUTTON** - Press to check proper calibration of RNAV 511. If the computer is properly calibrated, the displays (2 & 6) read the "active" WPT RADIAL and DISTANCE as dialed into the thumbwheels. Test may be performed anytime, (during or before flight).
10. **LOCKING SCREW** - Secures RNAV 511 in dustcover. Turn locking screw counterclockwise several turns to release unit from panel.
11. **RADIAL AND DISTANCE THUMBWHEELS** - Waypoint location (RADIAL AND DISTANCE) is dialed into thumbwheels to 0.1° and 0.1 NM resolution. Maximum waypoint offset from the VORTAC is 199.9 NM.

Figure 1. Foster Area Nav (Type 511) Computer Operating Controls and Indicators (Sheet 2 of 2)

SECTION 4

NORMAL OPERATION

VOR/LOC OPERATION

VOR NAVIGATION CIRCUITS VERIFICATION TESTS:

1. See appropriate Nav/Com supplement.

AREA NAVIGATION OPERATING NOTES

1. Proper RNAV operation requires valid VOR and DME inputs to the RNAV system. In certain areas, the ground station antenna patterns and transmitter power may be inadequate to provide valid signals to the RNAV. For this reason, intermittent RNAV signal loss may be experienced enroute.
2. When a waypoint from one VORTAC is displaced over a second VORTAC, interference from the second VORTAC sometimes causes erratic and unusable BEARING and RANGE displays on the RNAV at low altitude.
3. The RNAV BEARING readout (to the waypoint) becomes extremely sensitive and may become unusable within 1 - 1 1/2 miles of the waypoint. Thus, the RANGE readout is the primary means of approximating waypoint passage.
4. Tracking from a waypoint is not recommended since the pilot would have to fly a reciprocal bearing and make error corrections in the opposite direction from flying to a waypoint.

DIAGNOSTIC FUNCTIONS

All RNAV systems are rendered inoperative under certain conditions. The RNAV 511 provides a Flag mode and permits a diagnostic interpretation of why the system is inoperative.

FLAG MODE INDICATIONS:

1. Six "Bars" Appear in the Digital Displays (2 & 6):
 - a. PRESS VOR/DME button (5) to determine if the VOR radial signal is absent. If VOR radial signal is absent, bars will change to show as "000" in the BEARING window (2). (One possible cause of this condition could be that the NAV receiver is channeled to a localizer signal.)
 - b. Excess RADIAL waypoint address entry (11 or 8) such as 360.1° or 389° -- The computer will not accept this entry.

- c. Excess RANGE to Waypoint (6) -- This would be any value over 199 NM. (A check of aircraft position relative to the VORTAC and Waypoint will detect and verify this condition.)
2. Missing DME Signal Display -- This will show as "00.0" in the RANGE NM digital display (6) when the VOR/DME button (2) is held in. The missing DME signal is then the reason for the FLAG condition. (If valid VOR and DME data is displayed, then another cause must be sought.)
3. Temporary Display of Unchanging Random Digits in the BEARING and RANGE Windows (2 & 6) at Time of Initial Turn-ON -- Such a condition is caused by a random interpretation of the micro processor cycle. The RNAV 511 will Flag this malfunction by a complete blanking of all display functions. The pilot can reset the micro processor cycle by turning the RNAV OFF and then ON.

WAYPOINT PROGRAMMING

1. Using a VFR Sectional or other appropriate maps -- DETERMINE distance and bearing for desired waypoint(s) from appropriate VOR/DME stations.
2. VHF Navigation Receiver -- ON (When installed with DME 190, RNAV 511 is connected to the Nav 1 Rcvr. When installed with the 400 DME, RNAV 511 may be connected to either the Nav 1 or Nav 2 Rcvr.) and channeled to the desired VORTAC.
3. DME ON/OFF Switch -- ON.
4. DME Remote Channeling Selector on DME 190 Selector -- SET to REM position on DME 190.
5. DME Mode Selector on 400 DME -- SET TO desired NAV 1 or NAV 2 position on 400 DME.

NOTE

RNAV and HOLD positions on the 400 DME Mode Selector are not used with this installation. RNAV is automatically channeled to the selected Nav receiver.

6. GS/TTS Selector Switch (on 400 DME) -- SET as desired. (Will only display ground speed component or time-to-station at that speed to the selected VOR --not the waypoint.)
7. RADIAL and DISTANCE Thumbwheels -- SET to first waypoint RADIAL and DISTANCE. (Typically, the first waypoint is set into the left side set of thumbwheels.)
8. RADIAL and DISTANCE Thumbwheels -- SET to second waypoint RADIAL and DISTANCE. (Typically, the second waypoint is set into the right set of thumbwheels.)
9. Left WPT Pushbutton Switch -- PUSH in.
 - a. First waypoint RADIAL and DISTANCE are placed in unit as a waypoint.

10. RNAV BEARING Readout -- OBSERVE readout for magnetic BEARING to waypoint.
11. RNAV RANGE Readout -- OBSERVE readout of first waypoint distance.
12. TEST Pushbutton -- PRESS and observe that the desired BEARING and RANGE readouts of the waypoint thumbwheel settings are displayed.
 - a. BEARING Display Readout -- DISPLAYS readout of first waypoint bearing.
 - b. RANGE Display Readout -- DISPLAYS readout of first waypoint distance.
13. DG or HSI -- CONTROL AIRCRAFT as required to maintain desired track to or from waypoint.

NOTE

Due to wind drift, it will be necessary to fly a few degrees plus or minus the calculated BEARING readout in order to maintain the desired BEARING readout on the computer.

14. VOR/DME Pushbutton -- PRESS at anytime to observe the radial and DME distance from the VORTAC associated with the waypoint.
15. Upon Waypoint Passage -- CHECK or SELECT next desired waypoint's VORTAC frequency on the selected Nav receiver and then PRESS next WPT Pushbutton in and repeat steps 9 through 12 to proceed to next waypoint which was dialed in the right set of thumbwheels.

NOTE

Waypoint passage will begin to be reflected on the RNAV BEARING display about 1.5 NM from the waypoint. Waypoint passage will be reflected by a rapid change of BEARING displays. Therefore, the pilot should fly the established inbound predetermined DG heading until waypoint passage has occurred or until the next waypoint is selected.

16. Left Hand RADIAL and DISTANCE Thumbwheels -- SET to next waypoint RADIAL and DISTANCE.

NOTE

As first waypoint is reached, it can be replaced with the next waypoint RADIAL and DISTANCE. Then a new

waypoint, if necessary, can be set into the right-hand thumbwheels after the initial right-hand waypoint is passed. This procedure can be followed for as many waypoints as necessary, providing that the desired Nav receiver is selected and the VORTAC frequency has been re-channelled to each VORTAC station.

SECTION 5

PERFORMANCE

There is no change to the airplane performance when this avionic equipment is installed.

SUPPLEMENT

HF TRANSCEIVER (TYPE PT10-A)

SECTION 1 GENERAL

The PT10-A HF Transceiver, shown in Figure 1, is a 10-channel AM transmitter-receiver which operates in the frequency range of 2.0 to 18.0 Megahertz. The transceiver is automatically tuned to the operating frequency by a Channel Selector. The operating controls for the unit are mounted on the front panel of the transceiver. The system consists of a transceiver, antenna load box, fixed wire antenna and associated wiring.

The Channel Selector Knob determines the operating frequency of the transmitter and receiver. The frequencies of operation are shown on the frequency chart adjacent to the channel selector.

The VOLUME control incorporates the power switch for the transceiver. Clockwise rotation of the volume control turns the set on and increases the volume of audio.

The meter on the face of the transceiver indicates transmitter output.

The system utilizes the airplane microphone, headphone and speaker. Operation and description of the audio control panel used in conjunction with this radio is shown and described in Section 7 of this handbook.

SECTION 2 LIMITATIONS

There is no change to the airplane limitations when this avionic equipment is installed.

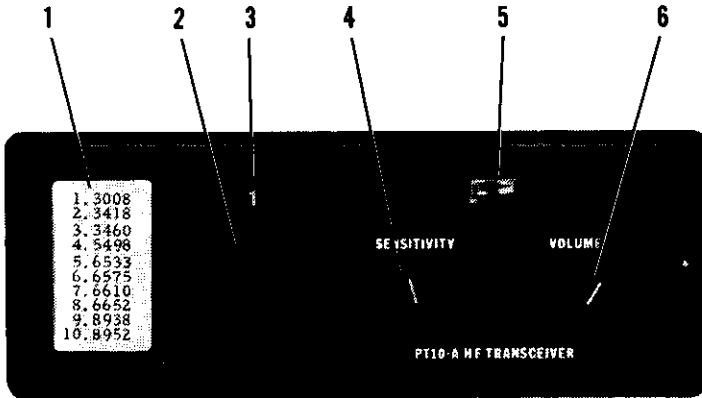

1. **FREQUENCY CHART** - Shows the frequency of the channel in use (frequencies shown may vary and are shown for reference purposes only).
2. **CHANNEL SELECTOR** - Selects channels 1 thru 10 as listed in the frequency chart.
3. **CHANNEL READOUT WINDOW** - Displays channel selected in frequency chart.
4. **SENSITIVITY CONTROL** - Controls the receiver sensitivity for audio gain.
5. **ANTENNA TUNING METER** - Indicates the energy flowing from the transmitter into the antenna. The optimum power transfer is indicated by the maximum meter reading.
6. **ON/OFF VOLUME CONTROL** - Turns complete set on and controls volume of audio.

Figure 1. HF Transceiver (Type PT10-A)

SECTION 3 EMERGENCY PROCEDURES

There is no change to the airplane emergency procedures when this avionic equipment is installed.

SECTION 4 NORMAL PROCEDURES

COMMUNICATIONS TRANSCEIVER OPERATION:

1. XMTR SEL Switch (on audio control panel) -- SELECT transmitter.
2. SPEAKER/PHONE Selector Switch (on audio control panel) -- SELECT desired mode.
3. VOLUME Control -- ON (allow equipment to warm up and adjust audio to comfortable listening level).
4. Frequency Chart -- SELECT desired operating frequency.
5. Channel Selector -- DIAL in frequency selected in step 4.
6. SENSITIVITY Control -- ROTATE clockwise to maximum position.

NOTE

If receiver becomes overloaded by very strong signals, back off SENSITIVITY control until background noise is barely audible.

NOTE

The antenna tuning meter indicates the energy flowing from the airplane's transmitter into the antenna. The optimum power transfer is indicated by the maximum meter reading.

7. Mike Button:
 - a. To Transmit -- DEPRESS and SPEAK into microphone.

NOTE

Sidetone is not available on this radio.

- b. To Receive -- RELEASE mike button.

SECTION 5

PERFORMANCE

There is no change to the airplane performance when this avionic equipment is installed. However, the installation of an externally mounted antenna or several related external antennas, will result in a minor reduction in cruise performance.

SUPPLEMENT

SSB HF TRANSCEIVER

(TYPE ASB-125)

SECTION 1

GENERAL

The ASB-125 HF transceiver is an airborne, 10-channel, single sideband (SSB) radio with a compatible amplitude modulated (AM) transmitting-receiving system for long range voice communications in the 2 to 18 MHz frequency range. The system consists of a panel mounted receiver/exciter, a remote mounted power amplifier/power supply, an antenna coupler and an externally mounted, fixed wire, medium/high frequency antenna.

A channel selector knob determines the operating frequency of the transceiver which has predetermined crystals installed to provide the desired operating frequencies. A mode selector control is provided to supply the type of emission required for the channel, either sideband, AM or telephone for public correspondence. An audio knob, clarifier knob and squelch knob are provided to assist in audio operation during receive. In addition to the aforementioned controls, which are all located on the receiver/exciter, a meter is incorporated to provide antenna loading readouts.

The system utilizes the airplane microphone, headphone and speaker. Operation and description of the audio control panel used in conjunction with this radio is shown and described in Section 7 of this handbook.

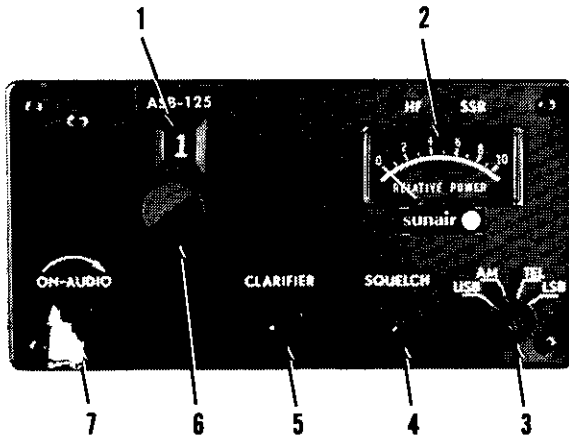

1. CHANNEL WINDOW - Displays selected channel.
2. RELATIVE POWER METER - Indicates relative radiated power of the power amplifier/antenna system.
3. MODE SELECTOR CONTROL - Selects one of the desired operating modes:
 - USB - Selects upper sideband operation for long range voice communications.
 - AM - Selects compatible AM operation and full AM reception.
 - TEL - Selects upper sideband with reduced carrier, used for public correspondence telephone and ship-to-shore.
 - LSB - (Optional) Selects lower sideband operation (not legal in U.S., Canada and most other countries).
4. SQUELCH CONTROL - Used to adjust signal threshold necessary to activate receiver audio. Clockwise rotation increases background noise (decreases squelch action); counterclockwise rotation decreases background noise.
5. CLARIFIER CONTROL - Used to "clarify" single sideband speech during receive while in USB mode only.
6. CHANNEL SELECTOR CONTROL - Selects desired channel. Also selects AM mode if channel frequency is 2003 kHz, 2182 kHz or 2638 kHz.
7. ON - AUDIO CONTROL - Turns set ON and controls receiver audio gain.

Figure 1. SSB HF Transceiver Operating Controls

SECTION 2 LIMITATIONS

There is no change to the airplane limitations when this avionic equipment is installed.

SECTION 3 EMERGENCY PROCEDURES

There is no change to the airplane emergency procedures when this avionic equipment is installed.

SECTION 4 NORMAL PROCEDURES

COMMUNICATIONS TRANSCEIVER OPERATION:

NOTE

The pilot should be aware of the two following radio operational restrictions:

- a. For sideband operation in the United States, Canada and various other countries, only the upper sideband may be used. Use of lower sideband is prohibited.
 - b. Only AM transmissions are permitted on frequencies 2003 kHz, 2182 kHz and 2638 kHz. The selection of these channels will automatically select the AM mode of transmission.
1. XMTR SEL Switch (on audio control panel) -- SELECT transceiver.
 2. SPEAKER/PHONE Selector Switches (on audio control panel) -- SELECT desired mode.
 3. ON-AUDIO Control -- ON (allow equipment to warm up for 5 minutes for sideband or one minute for AM operation and adjust audio to comfortable listening level).
 4. Channel Selector Control -- SELECT desired frequency.
 5. Mode Selector Control -- SELECT operating mode.
 6. SQUELCH Control -- ADJUST clockwise for normal background noise output, then slowly adjust counterclockwise until the receiver is silent.

7. CLARIFIER Control -- ADJUST when upper single sideband RF signal is being received for maximum clarity.
8. Mike Button:
 - a. To Transmit -- DEPRESS and SPEAK into microphone.

NOTE

Sidetone is not available on this radio.

- b. To Receive -- RELEASE mike button.

NOTE

Voice communications are not available in the LSB mode.

NOTE

Lower sideband (LSB) mode is not legal in the U.S., Canada, and most other countries.

SECTION 5

PERFORMANCE

There is no change to the airplane performance when this avionic equipment is installed. However, the installation of an externally mounted antenna or several related external antennas, will result in a minor reduction in cruise performance.

SUPPLEMENT

OPTIONAL UNSLAVED HORIZONTAL SITUATION INDICATOR (HSI) (TYPE IG-832C)

SECTION 1 GENERAL

The IG-832C Horizontal Situation Indicator (HSI) is an additional navigation indicator option which provides a heading reference with respect to an unslaved directional gyro, a heading reference bug, VOR course selection, and a pictorial presentation of the airplane position relative to VOR and localizer courses and glide slopes. This indicator is used with Cessna 300 and 400 Nav/Com radios. When dual Nav/Com radios are installed, the HSI is coupled to the number 1 NAV/COM and a standard 300 or 400 series VOR/LOC course deviation indicator is coupled to the number 2 NAV/COM.

This system consists of a Horizontal Situation Indicator (HSI-Type IG-832C) and a remote mounted VOR/LOC Converter (Type B-445A). The indicator is unslaved and course datum is not available. When the HSI is installed with a 300A or 400B Autopilot system, a BC light is installed on the instrument panel, adjacent to the HSI, to alert the pilot of back-course operation. Each control and indicator function is described in Figure 1.

SECTION 2 LIMITATIONS

There is no change to the airplane limitations when this instrument is installed.

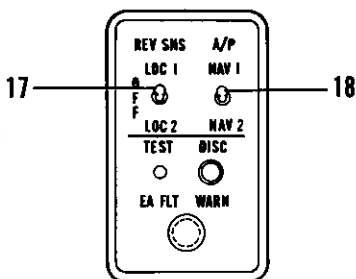
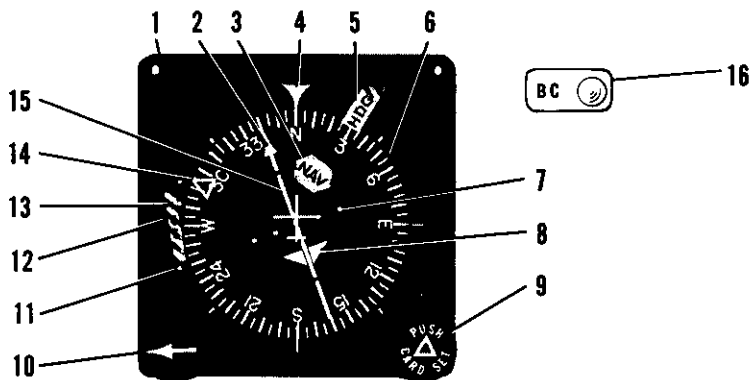

USED WITH 400B AUTOPILOT
ON 210 SERIES MODELS

1. **HORIZONTAL SITUATION INDICATOR (HSI)** - Provides a pictorial presentation of aircraft deviation relative to VOR radials and localizer beams. It also displays glide slope deviations and gives heading reference with respect to magnetic north when compass card is set to agree with compass.
2. **OMNI BEARING POINTER** - Indicates selected VOR course or localizer course on compass card (6). The selected VOR radial or localizer remains set on the compass card when the compass card (6) is rotated.
3. **NAV FLAG** - When flag is in view, indicates that the NAV receiver signal being received is not reliable.

Figure 1. Horizontal Situation Indicator (HSI) (Type IG-832C)
(Sheet 1 of 3)

4. HEADING REFERENCE (LUBBER LINE) - Indicates aircraft magnetic heading on compass card (6).
5. HEADING WARNING FLAG (HDG) - When flag is in view, the heading display is invalid due to interruption of either electrical or vacuum power.
6. COMPASS CARD - Rotates to display heading of airplane with reference to lubber line (4). Must be set to agree with aircraft compass using Card Set Knob (9).
7. COURSE DEVIATION DOTS - Indicates aircraft displacement from VOR, or localizer beam center. A full scale (2 dots) course deviation bar (15) displacement represents the following deviations from beam center:
 - a. VOR = $\pm 10^\circ$ approx.
 - b. LOC = $\pm 2-1/2^\circ$ approx.
8. TO/FROM INDICATOR FLAG - Indicates direction of VOR station relative to selected course.
9. HEADING SELECTOR AND CARD SET KNOB (PUSH \blacktriangle CARD SET) - When rotated in normal (out) position, positions heading "bug" (14) on compass card (6) to indicate selected heading for reference or for autopilot tracking. When pushed in and rotated, sets compass card (6) to agree with magnetic compass. The omni bearing pointer (2), heading bug (14), and deviation bar (15) rotate with the compass card (6).

NOTE

The compass card (6) must be reset periodically to compensate for precessional errors in the gyro.

10. COURSE SELECTOR (\uparrow) KNOB - When rotated, positions omni bearing pointer (2) on the compass card (6) to select desired VOR radial or localizer course.
11. GLIDE SLOPE SCALE - Indicates displacement from glide slope beam center. A glide slope deviation bar displacement of 2 dots, represents full scale (0.7°) deviation above or below glide slope beam centerline.
12. GLIDE SLOPE POINTER - Indicates on glide slope scale (11) aircraft displacement from glide slope beam center.
13. GLIDE SLOPE FLAG - When in view, indicates glide slope receiver signal is not reliable.
14. HEADING BUG - Indicates selected reference heading relative to compass card (6).
15. COURSE (OMNI) DEVIATION BAR - Bar is center portion of omni bearing pointer and moves laterally to pictorially indicate relationship of aircraft to selected course. It relates in degrees of angular displacement from VOR radials or localizer beam center (see Item 7).

Figure 1. Horizontal Situation Indicator (HSI) (Type IG-832C)
(Sheet 2 of 3)

16. **BACK-COURSE LIGHT (BC)** (Installed in a remote position, as shown, with 300A and 400B autopilots only.) - The remote amber BC light will illuminate when back-course operation is selected by the REV SNS LOC 1 switch (17) mounted in the lower center portion of the instrument panel or the BC function of 300A autopilot. Light dimming is only available when installed with an audio control panel incorporating the annunciator lights DAY/NITE selector switch.

CAUTION

When back-course operation is selected, the course (omni) deviation bar (15) on the HSI does not reverse. However, selection of back-course operation will always cause the localizer signal to the autopilot to reverse for back-course operation.

17. **BACK COURSE REVERSE SENSE (REV SNS) LOC 1 OR LOC 2 SELECTOR SWITCH** - With AP switch ON (on 400A or 400B Autopilot control units) and either LOC 1 or LOC 2 selected, localizer signals to the Cessna 400A or 400B Autopilots will reverse for back-course operation. With autopilot ON or OFF, the course (omni) deviation bar on the HSI will not reverse but the standard CDI pointer will reverse depending on the position of the REV SNS switch.
18. **AUTOPILOT (A/P) NAV 1 OR NAV 2 SELECTOR SWITCH** - (Installed with 400B Autopilot only) Selects appropriate signals from the desired navigation receiver to be coupled to the autopilot.

SECTION 3
EMERGENCY PROCEDURES

There is no change to the airplane emergency procedures when this instrument is installed.

Figure 1. Horizontal Situation Indicator (HSI) (Type IG-832C)
(Sheet 3 of 3)

SECTION 4

NORMAL PROCEDURES

NOTE

Both electrical and vacuum power must be supplied to this instrument for proper functioning. Absence of either will result in unreliable heading information.

Normal procedures for operation of this system differ little from those required for the more conventional Course Deviation Indicators. However, several small differences are worth noting.

The rectilinear movement of the omni deviation bar in combination with the rotation of the compass card in response to heading changes, provides an intuitive picture of the navigation situation at a glance when turned to an omni station. When tuned to a localizer frequency, the omni bearing pointer must be set to the inboard front course for both front and back-course approaches to retain this pictorial presentation.

When the HSI system is installed with a Cessna 300A (Type AF-395A) or Cessna 400B (Type IF-550A) Autopilot, a back-course indicator light labeled BC, is mounted adjacent to the HSI and will illuminate amber when the reverse sense (REV SNS) switch (mounted in the autopilot's accessory unit on 210 Models) is placed in the ON (LOC 1) position to alert the pilot that back-course operation is selected. The HSI needle will not be reversed but the LOC signals to the autopilot will be. Light dimming for the BC light is only available when installed with an audio control panel incorporating the annunciator lights DAY/NITE selector switch.

For normal procedures with autopilots, refer to the 300A or 400B Autopilot Supplements in this handbook if they are listed in this section as options.

SECTION 5

PERFORMANCE

There is no change to the airplane performance when this instrument is installed.

SUPPLEMENT

CESSNA NAVOMATIC 200A AUTOPILOT (Type AF-295B)

SECTION 1 GENERAL

The Cessna 200A Navomatic is an all electric, single-axis (aileron control) autopilot system that provides added lateral and directional stability. Components are a computer-amplifier, a turn coordinator, an aileron actuator, and a course deviation indicator(s) incorporating a localizer reversed (BC) indicator light

Roll and yaw motions of the airplane are sensed by the turn coordinator gyro. The computer-amplifier electronically computes the necessary correction and signals the actuator to move the ailerons to maintain the airplane in the commanded lateral attitude.

The 200A Navomatic will also capture and track a VOR or localizer course using signals from a VHF navigation receiver.

The operating controls for the Cessna 200A Navomatic are located on the front panel of the computer-amplifier, shown in Figure 1. The primary function pushbuttons (DIR HOLD, NAV CAPT, and NAV TRK), are interlocked so that only one function can be selected at a time. The HISENS and BACK CRS pushbuttons are not interlocked so that either or both of these functions can be selected at any time.

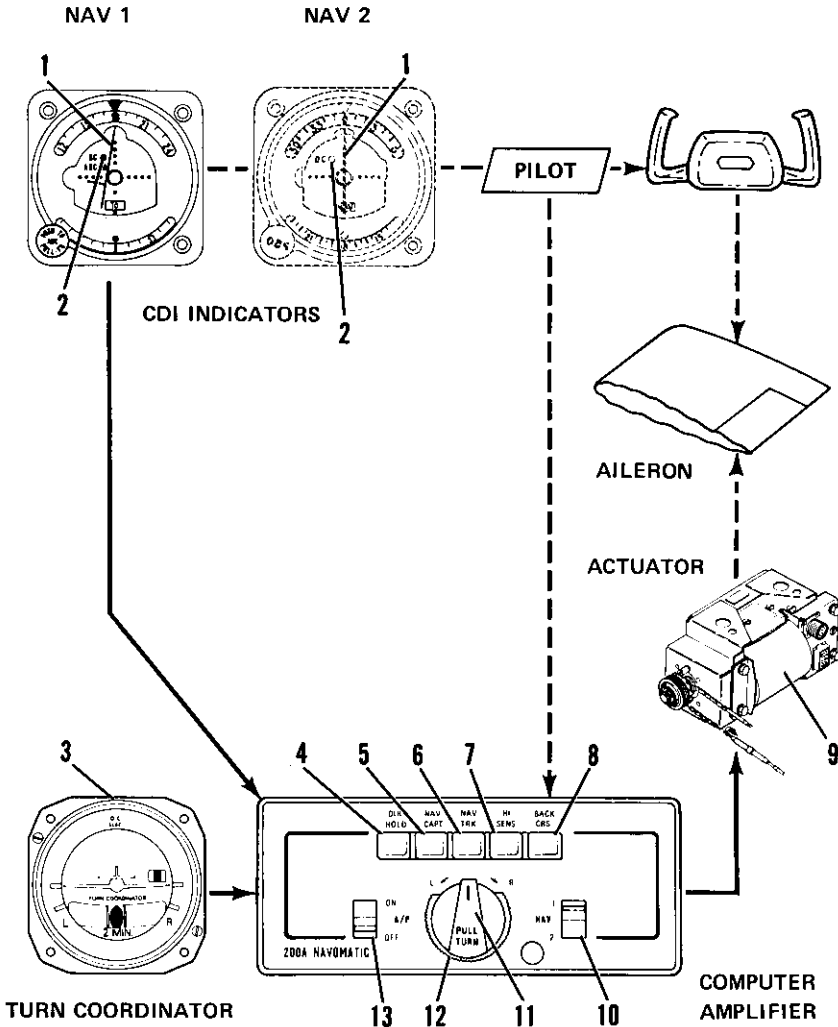

Figure 1. Cessna 200A Autopilot, Operating Controls and Indicators
 (Sheet 1 of 2)

1. COURSE DEVIATION INDICATOR - Provides VOR/LOC navigation inputs to autopilot for intercept and tracking modes.
2. LOCALIZER REVERSED INDICATOR LIGHT - Amber light, labeled BC, illuminates when BACK CRS button is pushed in (engaged) and LOC frequency selected. BC light indicates course indicator needle is reversed on selected receiver (when turned to a localizer frequency). This light is located within the CDI indicator.
3. TURN COORDINATOR - Senses roll and yaw for wings leveling and command turn functions.
4. DIR HOLD PUSHBUTTON - Selects direction hold mode. Airplane holds direction it is flying at time button is pushed.
5. NAV CAPT PUSHBUTTON - Selects NAV capture mode. When parallel to desired course, the airplane will turn to a pre-described intercept angle and capture selected VOR or LOC course.
6. NAV TRK PUSHBUTTON - Selects NAV track mode. Airplane tracks selected VOR or LOC course.
7. HI SENS PUSHBUTTON - During NAV CAPT or NAV TRK operation, this high sensitivity setting increases autopilot response to NAV signal to provide more precise operation during localizer approach. In low sensitivity position (pushbutton out), response to NAV signal is dampened for smoother tracking of enroute VOR radials; it also smooths out effect of course scalloping during NAV operation.
8. BACK CRS PUSHBUTTON - Used with LOC operation only. With A/P switch OFF or ON, and when navigation receiver selected by NAV switch is set to a localizer frequency, it reverses normal localizer needle indication (CDI) and causes localizer reversed (BC) light to illuminate. With A/P switch ON, reverses localizer signal to autopilot.
9. ACTUATOR - The torque motor in the actuator causes the ailerons to move in the commanded direction.
10. NAV SWITCH - Selects NAV 1 or NAV 2 navigation receiver.
11. PULL TURN KNOB - When pulled out and centered in detent, airplane will fly wings-level; when turned to the right (R), the airplane will execute a right, standard rate turn; when turned to the left (L), the airplane will execute a left, standard rate turn. When centered in detent and pushed in, the operating mode selected by a pushbutton is engaged.
12. TRIM - Used to trim autopilot to compensate for minor variations in aircraft trim or weight distribution. (For proper operation, the aircraft's rudder trim, if so equipped, must be manually trimmed before the autopilot is engaged.)
13. A/P SWITCH - Turns autopilot ON or OFF.

Figure 1. Cessna 200A Autopilot, Operating Controls and Indicators
(Sheet 2 of 2)

SECTION 2 LIMITATIONS

The following autopilot limitation must be adhered to:

BEFORE TAKE-OFF AND LANDING:

1. A/P ON-OFF Switch -- OFF.

SECTION 3 EMERGENCY PROCEDURES

TO OVERRIDE THE AUTOPILOT:

1. Airplane Control Wheel -- ROTATE as required to override autopilot.

NOTE

The servo may be overpowered at anytime without damage.

TO TURN OFF AUTOPILOT:

1. A/P ON-OFF Switch -- OFF.

SECTION 4 NORMAL PROCEDURES

BEFORE TAKE-OFF AND LANDING:

1. A/P ON-OFF Switch -- OFF.
2. BACK CRS Button -- OFF (see Caution note under Nav Capture).

NOTE

Periodically verify operation of amber warning light(s), labeled BC on CDI(s), by engaging BACK CRS button with a LOC frequency selected.

INFLIGHT WINGS LEVELING:

1. Airplane Rudder Trim -- ADJUST for zero slip ("Ball" centered on Turn Coordinator).
2. PULL-TURN Knob -- CENTER and PULL out.
3. A/P ON-OFF Switch -- ON.
4. Autopilot TRIM Control -- ADJUST for zero turn rate (wings level indication on Turn Coordinator).

NOTE

For optimum performance in airplanes equipped as float-planes, use autopilot only in cruise flight or in approach configuration with flaps down no more than 10° and airspeed no lower than 75 KIAS on 172 and R172 Series Models or 90 KIAS on 180, 185, U206 and TU206 Series Models.

COMMAND TURNS:

1. PULL-TURN Knob -- CENTER, PULL out and ROTATE.

DIRECTION HOLD:

1. PULL-TURN Knob -- CENTER and PULL out.
2. Autopilot TRIM Control -- ADJUST for zero turn rate.
3. Airplane Rudder Trim -- ADJUST for zero slip ("Ball" centered).
4. DIR HOLD Button -- PUSH.
5. PULL-TURN Knob -- PUSH in detent position when airplane is on desired heading.
6. Autopilot TRIM Control -- READJUST for zero turn rate.

NAV CAPTURE (VOR/LOC):

1. PULL-TURN Knob -- CENTER and PULL out.
2. NAV 1-2 Selector Switch -- SELECT desired VOR receiver.
3. Nav Receiver OBS or ARC Knob -- SET desired VOR course (if tracking omni).

NOTE

Optional ARC knob should be in center position and ARC amber warning light should be off.

4. NAV CAPT Button -- PUSH.
5. HI SENS Button -- PUSH for localizer and "close-in" omni intercepts.

6. BACK CRS Button -- PUSH only if intercepting localizer front course outbound or back course inbound.

CAUTION

With BACK CRS button pushed in and localizer frequency selected, the CDI on selected nav radio will be reversed even when the autopilot switch is OFF.

7. PULL-TURN Knob -- Turn airplane parallel to desired course.

NOTE

Airplane must be turned until heading is within $\pm 5^\circ$ of desired course.

8. PULL TURN Knob -- CENTER and PUSH in. The airplane should then turn toward desired course at $45^\circ \pm 10^\circ$ intercept angle (if the CDI needle is in full deflection).

NOTE

If more than 15 miles from the station or more than 3 minutes from intercept, use a manual intercept procedure.

NAV TRACKING (VOR/LOC):

1. NAV TRK Button -- PUSH when CDI centers and airplane is within $\pm 5^\circ$ of course heading.
2. HI SENS BUTTON -- DISENGAGE for enroute omni tracking (leave ENGAGED for localizer).
3. Autopilot TRIM Control -- READJUST as required to maintain track.

NOTE

Optional ARC function, if installed, should not be used for autopilot operation. If airplane should deviate off course, pull out PULL TURN knob and readjust airplane rudder trim for straight flight on the Turn Coordinator. Push in PULL TURN knob to reintercept course. If deviation persists, progressively make slight adjustments of autopilot TRIM control towards the course as required to maintain track.

SECTION 5 PERFORMANCE

There is no change to the airplane performance when this avionic equipment is installed.

SUPPLEMENT

CESSNA 300 ADF (Type R-546E)

SECTION 1 GENERAL

The Cessna 300 ADF is a panel-mounted, digitally tuned automatic direction finder. It is designed to provide continuous 1 kHz digital tuning in the frequency range of 200 kHz to 1,699 kHz and eliminates the need for mechanical band switching. The system is comprised of a receiver, a bearing indicator, a loop antenna, and a sense antenna. Operating controls and displays for the Cessna 300 ADF are shown and described in Figure 1. The audio system used in conjunction with this radio for speaker-phone selection is shown and described in Section 7 of this handbook.

The Cessna 300 ADF can be used for position plotting and homing procedures, and for aural reception of amplitude-modulated (AM) signals.

With the function selector knob at ADF, the Cessna 300 ADF provides a visual indication, on the bearing indicator, of the bearing to the transmitting station relative to the nose of the airplane. This is done by combining signals from the sense antenna with signals from the loop antenna.

With the function selector knob at REC, the Cessna 300 ADF uses only the sense antenna and operates as a conventional low-frequency receiver.

The Cessna 300 ADF is designed to receive transmission from the following radio facilities: commercial AM broadcast stations, low-frequency range stations, non-directional radio beacons, ILS compass locators.

SECTION 2 LIMITATIONS

There is no change to the airplane limitations when this avionic equipment is installed.

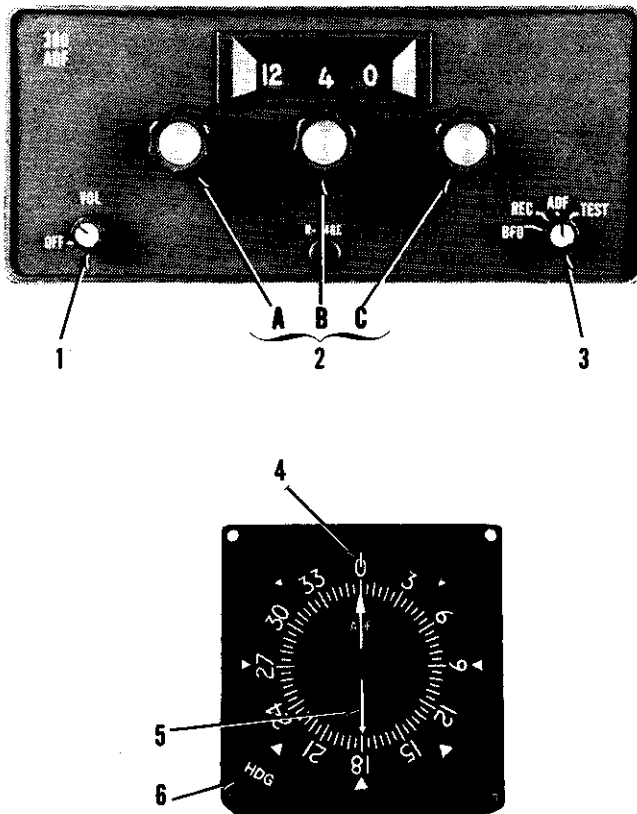

1. **OFF/VOL CONTROL** - Controls primary power and audio output level. Clockwise rotation from OFF position applies primary power to receiver; further clockwise rotation increases audio level.
2. **FREQUENCY SELECTORS** - Knob (A) selects 100-kHz increments of receiver frequency, knob (B) selects 10-kHz increments, and knob (C) selects 1 kHz increments.

Figure 1. Cessna 300 ADF Operating Controls and Indicators (Sheet 1 of 2)

3. FUNCTION SWITCH:

BFO: Selects operation as communication receiver using only sense antenna and activates 1000-Hz tone beat frequency oscillator to permit coded identifier of stations transmitting keyed CW signals (Morse Code) to be heard.

REC: Selects operation as standard communication receiver using only sense antenna.

ADF: Set operates as automatic direction finder using loop and sense antennas.

TEST: Momentary-on position used during ADF operation to test bearing reliability. When held in TEST position, slews indicator pointer clockwise; when released, if bearing is reliable, pointer returns to original bearing position.

4. **INDEX (ROTATABLE CARD)** - Indicates relative, magnetic, or true heading of aircraft, as selected by HDG control.
5. **POINTER** - Indicates station bearing in degrees of azimuth, relative to the nose of the aircraft. When heading control is adjusted, indicates relative, magnetic, or true bearing of radio signal.
6. **HEADING CARD CONTROL (HDG)** - Rotates card to set in relative, magnetic, or true bearing information.

SECTION 3

EMERGENCY PROCEDURES

There is no change to the airplane emergency procedures when this avionic equipment is installed.

SECTION 4

NORMAL PROCEDURES

TO OPERATE AS A COMMUNICATIONS RECEIVER ONLY:

1. OFF/VOL Control -- ON.
2. Function Selector Knob -- REC.
3. Frequency Selector Knobs -- SELECT operating frequency.
4. ADF SPEAKER/PHONE Selector Switch (on audio control panel) -- SELECT speaker or phone position as desired.
5. VOL Control -- ADJUST to desired listening level.

TO OPERATE AS AN AUTOMATIC DIRECTION FINDER:

1. OFF/VOL Control -- ON.
2. Frequency Selector Knobs -- SELECT operating frequency.
3. ADF SPEAKER/PHONE Selector Switch (on audio control panel) -- SELECT AS DESIRED.
4. Function Selector Knob -- ADF position and note relative bearing on indicator.

TO TEST RELIABILITY OF AUTOMATIC DIRECTION FINDER:

1. Function Selector Knob -- ADF position and note relative bearing on indicator.
2. Function Selector Knob -- TEST position and observe that pointer moves away from relative bearing at least 10 to 20 degrees.
3. Function Selector Knob -- ADF position and observe that pointer returns to same relative bearing as in step (1).

TO OPERATE BFO:

1. OFF/VOL Control -- ON.
2. Function Selector Knob -- BFO.
3. Frequency Selector Knobs -- SELECT operating frequency.
4. ADF SPEAKER/PHONE Selector Switch (on audio control panel) -- SELECT speaker or phone position as desired.

5. VOL Control -- ADJUST to desired listening level.

NOTE

A 1000-Hz tone is heard in the audio output when a CW signal (Morse Code) is tuned in properly.

SECTION 5 PERFORMANCE

There is no change to the airplane performance when this avionic equipment is installed. However, the installation of an externally mounted antenna or related external antennas, will result in a minor reduction in cruise performance.

SUPPLEMENT

CESSNA 300 NAV/COM (720-Channel - Type RT-385A)

SECTION 1 GENERAL

The Cessna 300 Nav/Com (Type RT-385A), shown in figure 1, consists of a panel-mounted receiver-transmitter and a single or dual-pointer remote course deviation indicator.

The set includes a 720-channel VHF communications receiver-transmitter and a 200-channel VHF navigation receiver, both of which may be operated simultaneously. The communications receiver-transmitter receives and transmits signals between 118.000 and 135.975 MHz in 25-kHz steps. The navigation receiver receives omni and localizer signals between 108.00 and 117.95 MHz in 50-kHz steps. The circuits required to interpret the omni and localizer signals are located in the course deviation indicator. Both the communications and navigation operating frequencies are digitally displayed by incandescent readouts on the front panel of the Nav/Com.

A DME receiver-transmitter or a glide slope receiver, or both, may be interconnected with the Nav/Com set for automatic selection of the associated DME or glide slope frequency. When a VOR frequency is selected on the Nav/Com, associated VORTAC or VOR-DME station frequency will also be selected automatically; likewise, if a localizer frequency is selected, the associated glide slope will be selected automatically.

The course deviation indicator includes either a single-pointer and related NAV flag for VOR/LOC indication only, or dual pointers and related NAV and GS flags for both VOR/LOC and glide slope indications. Both types of course deviation indicators incorporate a back-course lamp (BC) which lights when optional back course (reversed sense) operation is selected. Both types may be provided with Automatic Radial Centering which, depending on how it is selected, will automatically indicate the bearing TO or FROM the VOR station.

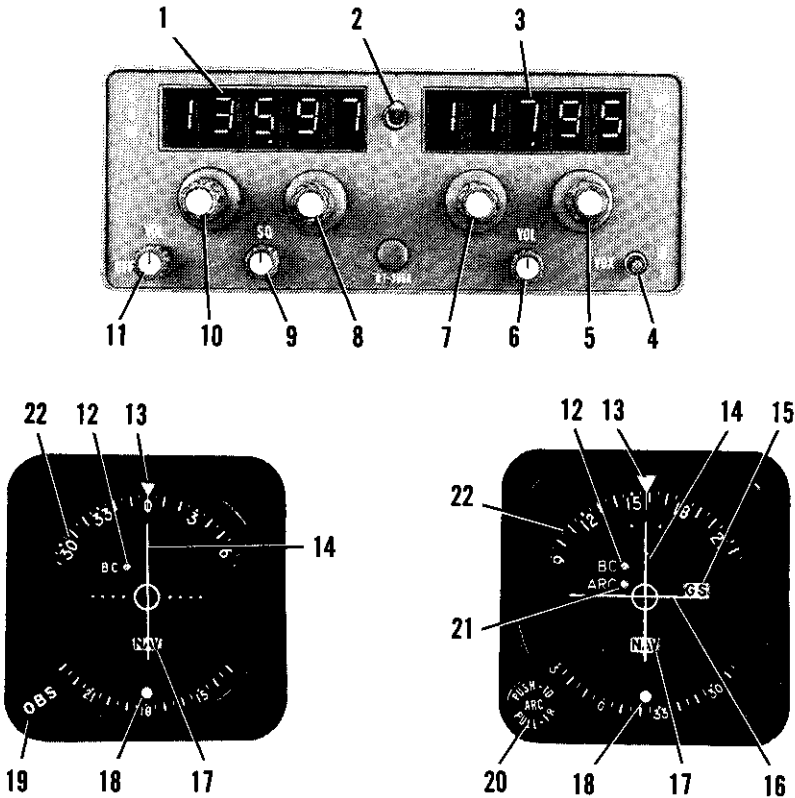

1. COMMUNICATION OPERATING FREQUENCY READOUT (Third-decimal-place is shown by the position of the "5-0" switch).
2. 5-0 SWITCH - Part of Com Receiver-Transmitter Fractional MHz Frequency Selector. In "5" position, enables Com frequency readout to display and Com Fractional MHz Selector in .05-MHz steps between .025 and .975 MHz. In "0" position, enables COM frequency readout to display and Com Fractional MHz Selector to select frequency in .05-MHz steps between .000 and .950 MHz.

NOTE

The "5" or "0" may be read as the third decimal digit, which is not displayed in the Com fractional frequency display.

Figure 1. Cessna 300 Nav/Com (Type RT-385A), Operating Controls and Indicators (Sheet 1 of 3)

3. NAVIGATION OPERATING FREQUENCY READOUT.
4. ID-VOX-T SWITCH - With VOR or LOC station selected, in ID position, station identifier signal is audible; in VOX (Voice) position, identifier signal is suppressed; in T (Momentary On) position, the VOR navigational self-test function is selected.
5. NAVIGATION RECEIVER FRACTIONAL MEGAHERTZ SELECTOR - Selects Nav frequency in .05-MHz steps between .00 and .95 MHz; simultaneously selects paired glide slope frequency and DME channel.
6. NAV VOL CONTROL - Adjusts volume of navigation receiver audio.
7. NAVIGATION RECEIVER MEGAHERTZ SELECTOR - Selects NAV frequency in 1-MHz steps between 108 and 117 MHz; simultaneously selects paired glide slope frequency and DME channel.
8. COMMUNICATION RECEIVER-TRANSMITTER FRACTIONAL MEGAHERTZ SELECTOR - Depending on position of 5-0 switch, selects COM frequency in .05-MHz steps between .000 and .975 MHz. The 5-0 switch identifies the last digit as either 5 or 0.
9. SQUELCH CONTROL - Used to adjust signal threshold necessary to activate COM receiver audio. Clockwise rotation increases background noise (decreases squelch action); counterclockwise rotation decreases background noise.
10. COMMUNICATION RECEIVER-TRANSMITTER MEGAHERTZ SELECTOR - Selects COM frequency in 1-MHz steps between 118 and 135 MHz.
11. COM OFF-VOL CONTROL - Combination on/off switch and volume control; turns on NAV/COM set and controls volume of communications receiver audio.
12. BC LAMP - Amber light illuminates when an autopilot's back-course (reverse sense) function is engaged; indicates course deviation pointer is reversed on selected receiver when tuned to a localizer frequency. Light dimming is only available when installed with an audio control panel incorporating the annunciator lights DAY/NITE selector switch.
13. COURSE INDEX - Indicates selected VOR course.
14. COURSE DEVIATION POINTER - Indicates course deviation from selected omni course or localizer centerline.
15. GLIDE SLOPE "GS" FLAG - When visible, red GS flag indicates unreliable glide slope signal or improperly operating equipment. Flag disappears when a reliable glide slope signal is being received.
16. GLIDE SLOPE DEVIATION POINTER - Indicates deviation from ILS glide slope.

Figure 1. Cessna 300 Nav/Com (Type RT-385A), Operating Controls and Indicators (Sheet 3 of 3)

17. NAV/TO-FROM INDICATOR - Operates only with a VOR or localizer signal. Red NAV position (Flag) indicates unusable signal. With usable VOR signal, indicates whether selected course is TO or FROM station. With usable localizer signal, shows TO.
18. RECIPROCAL COURSE INDEX - Indicates reciprocal of selected VOR course.
19. OMNI BEARING SELECTOR (OBS) - Rotates course card to select desired course.
20. AUTOMATIC RADIAL CENTERING (ARC-PUSH-TO/PULL-FR) SELECTOR - In center detent, functions as conventional OBS. Pushed to inner (Momentary On) position, turns OBS course card to center course deviation pointer with a TO flag, then returns to conventional OBS selection. Pulled to outer detent, continuously drives OBS course card to indicate bearing from VOR station, keeping course deviation pointer centered, with a FROM flag. ARC function will not operate on localizer frequencies.
21. AUTOMATIC RADIAL CENTERING (ARC) LAMP - Amber light illuminates when Automatic Radial Centering is in use. Light dimming is only available when installed with an audio control panel incorporating the annunciator lights DAY/NITE selector switch.
22. COURSE CARD - Indicates selected VOR course under course index.

Figure 1. Cessna 300 Nav/Com (Type RT-385A), Operating Controls and Indicators (Sheet 2 of 3)

The Cessna 300 Nav/Com incorporates a variable threshold automatic squelch. With this squelch system, you set the threshold level for automatic operation - the further clockwise the lower the threshold - or the more sensitive the set. When the signal is above this level, it is heard even if the noise is very close to the signal. Below this level, the squelch is fully automatic so when the background noise is very low, very weak signals (that are above the noise) are let through. For normal operation of the squelch circuit, just turn the squelch clockwise until noise is heard - then back off slightly until it is quiet, and you will have automatic squelch with the lowest practical threshold. This adjustment should be rechecked periodically during each flight to assure optimum reception.

All controls for the Nav/Com, except the standard omni bearing selector (OBS) knob or the optional automatic radial centering (ARC) knob located on the course deviation indicator, are mounted on the front panel of the receiver-transmitter. Operation and description of the audio control panels used in conjunction with this radio are shown and described in Section 7 of this handbook.

SECTION 2 LIMITATIONS

There is no change to the airplane limitations when this avionic equipment is installed.

SECTION 3 EMERGENCY PROCEDURES

There is no change to the airplane emergency procedures when this avionic equipment is installed. However, if the frequency readouts fail, the radio will remain operational on the last frequency selected. The frequency control should not be moved due to the difficulty of obtaining a known frequency under this condition.

SECTION 4

NORMAL PROCEDURES

COMMUNICATION RECEIVER-TRANSMITTER OPERATION:

1. COM OFF/VOL Control -- TURN ON; adjust to desired audio level.
2. XMTR SEL Switch (on audio control panel) -- SET to desired Nav/Com Radio.
3. SPEAKER/PHONE Selector Switches (on audio control panel) -- SET to desired mode.
4. 5-0 Fractional MHz Selector Switch -- SELECT desired operating frequency (does not affect navigation frequencies).
5. COM Frequency Selector Switch -- SELECT desired operating frequency.
6. SQ Control -- ROTATE counterclockwise to just eliminate background noise. Adjustment should be checked periodically to assure optimum reception.
7. Mike Button:
 - a. To Transmit -- DEPRESS and SPEAK into microphone.

NOTE

Sidetone may be selected by placing the AUTO selector switch (on audio control panel) in either the SPEAKER or PHONE position. Sidetone may be eliminated by placing the AUTO selector switch in the OFF position. Adjustment of sidetone on audio control panels supplied with three transmitters cannot be accomplished externally. However, audio control panels supplied with two or less transmitters have sidetone adjustment pots that are accessible through the front of the audio control panel with a small, screwdriver.

- b. To Receive -- RELEASE mike button.

NAVIGATION OPERATION:

NOTE

The pilot should be aware that on many Cessna airplanes equipped with the windshield mounted glide slope antenna, pilots should avoid use of 2700 ± 100 RPM on airplanes equipped with a two-bladed propeller or 1800 ± 100 RPM on airplanes equipped with a three-bladed propeller during ILS approaches to avoid oscillations of the glide slope deviation pointer caused by propeller interference.

1. COM OFF/VOL Control -- TURN ON.
2. SPEAKER/PHONE Selector Switches (on audio control panel) -- SET to desired mode.
3. NAV Frequency Selector Knobs -- SELECT desired operating frequency.
4. NAV VOL -- ADJUST to desired audio level.
5. ID-VOX-T Switch:
 - a. To Identify Station -- SET to ID to hear navigation station identifier signal.
 - b. To Filter Out Station Identifier Signal -- SET to VOX to include filter in audio circuit.
6. ARC PUSH-TO/PULL-FROM Knob (If Applicable):
 - a. To Use As Conventional OBS -- PLACE in center detent and select desired course.
 - b. To Obtain Bearing TO VOR Station -- PUSH (ARC/PUSH-TO) knob to inner (momentary on) position.

NOTE

ARC lamp will illuminate amber while the course card is moving to center with the course deviation pointer. After alignment has been achieved to reflect bearing to VOR, automatic radial centering will automatically shut down, causing the ARC lamp to go out.

- c. To Obtain Continuous Bearing FROM VOR Station -- PULL (ARC/PULL-FR) knob to outer detent.

NOTE

ARC lamp will illuminate amber, OBS course card will turn to center the course deviation pointer with a FROM flag to indicate bearing from VOR station.

7. OBS Knob (If Applicable) -- SELECT desired course.

VOR SELF-TEST OPERATION:

1. COM OFF/VOL Control -- TURN ON.
2. NAV Frequency Selector Switches -- SELECT usable VOR station signal.
3. OBS Knob -- SET for 0° course at course index; course deviation pointer centers or deflects left or right, depending on bearing of signal; NAV/TO-FROM indicator shows TO or FROM.
4. ID/VOX/T Switch -- PRESS to T and HOLD at T; course deviation pointer centers and NAV/TO-FROM indicator shows FROM.
5. OBS Knob -- TURN to displace course approximately 10° to either side of 0° (while holding ID/VOX/T to T). Course deviation pointer deflects full scale in direction corresponding to course displacement. NAV/TO-FROM indicator shows FROM.
6. ID/VOX/T Switch -- RELEASE for normal operation.

NOTE

This test does not fulfill the requirements of FAR 91.25.

SECTION 5

PERFORMANCE

There is no change to the airplane performance when this avionic equipment is installed. However, the installation of an externally mounted antenna or several related external antennas, will result in a minor reduction in cruise performance.

SUPPLEMENT

CESSNA 300 NAV/COM (Type RT-385A)

WITH

CESSNA 400 AREA NAVIGATION SYSTEM (Type RN-478A)

SECTION 1 GENERAL

The Cessna 300 Nav/Com (Type RT-385A) Set with Cessna 400 Area Navigation (RNAV-Type RN-478A) consists of a RT-385A Nav/Com, a R-476A DME system, a RN-478A Area Navigation Computer and a IN-442AR Course Deviation Indicator. The RN-478A includes circuits which combine the VOR navigation information with distance information from the R-476A DME system to provide data for area navigation. Operating information for the communication set and for VOR/localizer navigation is presented in this supplement. Operating information for area navigation and for DME is presented in separate supplements.

The RT-385A Receiver-Transmitter includes a 720-channel VHF communication receiver-transmitter which receives and transmits signals between 118.000 MHz and 135.975 MHz in 25-kHz steps. It also includes a 200-channel VHF navigation receiver which receives VOR and localizer signals between 108.00 MHz and 117.95 MHz in 50-kHz steps. The communication receiver-transmitter and the navigation receiver can be operated simultaneously.

The VOR or localizer signal from the No. 2 Navigation Receiver is applied to the converter circuits in the RN-478A Area Navigation Compu-

ter. The converter processes the received navigation signal to provide omni bearing or localizer information for display by the course indicator.

CAUTION

If the RNAV set is removed from the airplane or becomes inoperative, the associated VHF navigation indicator will be inoperative.

The course indicator includes a Course Deviation Indicator (CDI), an Omni Bearing Selector (OBS) and OFF/TO-FROM Indicator Flags. It also includes an RNAV lamp (RN) which lights when area navigation operation is selected, and a back-course lamp (BC) which lights when back-course operation is selected. The IN-442AR is offered as the standard Course Deviation Indicator.

All operating controls and indicators for the Cessna 300 Nav/Com are included on the front panel of the RT-385A Receiver-Transmitter and the associated Course Deviation Indicator. These controls and indicators are shown and described in Figure 1. Operating controls for the RN-478A Area Navigation Computer, which are used for area navigation, and operating controls for the associated Type R-476A DME are shown in the appropriate supplements in this manual. Operating controls for the audio control panels used in conjunction with this radio are shown and described in Section 7 of this handbook.

SECTION 2 LIMITATIONS

There is no change to the airplane limitations when this avionic equipment is installed.

SECTION 3 EMERGENCY PROCEDURES

There is no change to the airplane emergency procedures when this avionic equipment is installed. However, if the frequency readouts fail, the radio will remain operational on the last frequency selected. The frequency controls should not be moved due to the difficulty of obtaining a known frequency under this condition.

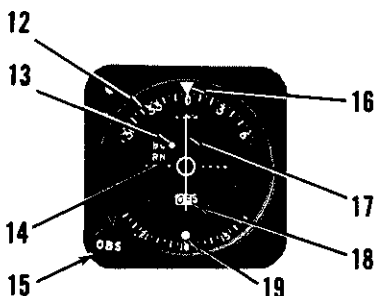
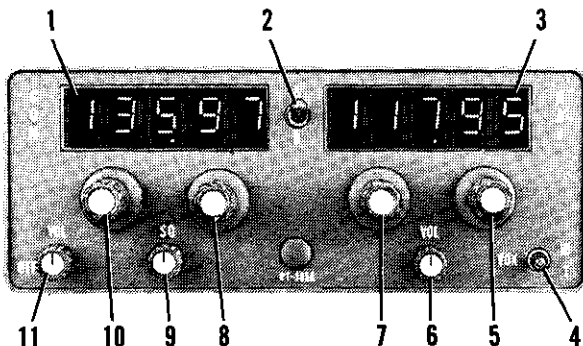

1. COMMUNICATION OPERATING FREQUENCY READOUT (Third-decimal-place is shown by the position of the "5-0" switch).
2. 5-0 SWITCH - Part of COM Receiver-Transmitter Fractional MHz Frequency Selector. In "5" position, enables COM frequency readout to display and COM Fractional MHz Selector to select frequency in .05 MHz steps between .025 and .975 MHz. In "0" position, enables COM frequency readout to display and COM Fractional MHz Selector to select frequency in .05 MHz steps between .000 and .950 MHz.

NOTE

The "5" or "0" may be read as the third decimal digit, which is not displayed in the Com fractional frequency display.

**Figure 1. Cessna 300 Nav/Com Set, Operating Controls and Indicators
(Sheet 1 of 3)**

3. NAVIGATION OPERATING FREQUENCY READOUT.
4. ID-VOX-T SWITCH - With VOR or LOC station selected, in ID position, station identifier signal is audible; in center VOX (Voice) position, identifier signal is suppressed; in T (Momentary On) position, the VOR navigational self-test function is selected.
5. NAVIGATIONAL RECEIVER FRACTIONAL MEGAHERTZ FREQUENCY SELECTOR - Selects NAV frequency in .05 MHz steps between .00 and .95 MHz; simultaneously selects paired glide slope frequency and DME channel.
6. NAV VOLUME CONTROL (VOL) - Adjusts volume of navigation receiver audio. Clockwise rotation increases audio level.
7. NAVIGATION RECEIVER MEGAHERTZ FREQUENCY SELECTOR - Selects NAV frequency in 1-MHz steps between 108 and 117 MHz; simultaneously selects paired glide slope frequency and DME channel.
8. COMMUNICATION RECEIVER-TRANSMITTER FRACTIONAL MHz FREQUENCY SELECTOR - Depending on position of the 5-0 Switch, selects COM frequency in .05 MHz steps between .000 and .975 MHz. The 5-0 switch identifies the last digit as either 5 or 0.
9. SQUELCH CONTROL - Used to adjust signal threshold necessary to activate COM receiver audio. Clockwise rotation increases background noise (decreases squelch action); counterclockwise rotation decreases background noise.
10. COMMUNICATION RECEIVER-TRANSMITTER MHz FREQUENCY SELECTOR - Selects COM frequency in 1 MHz steps between 118 and 135 MHz.
11. COM OFF-VOL CONTROL - Combination on/off switch and volume control; turns on NAV/COM Set and RNAV Computer circuits; controls volume of communication receiver audio.
12. COURSE CARD - Indicates selected VOR course under course index.
13. BACK COURSE LAMP (BC) - Amber light illuminates when an autopilot with reverse sense feature is installed and the reverse sense switch or the autopilot's back-course function is engaged and receiver is tuned to a localizer frequency; indicates course deviation pointer is reversed. BC light dimming is only available when installed with an audio control panel incorporating the annunciator lights DAY/NITE selector switch.
14. AREA NAV LAMP (RN) - When green light is illuminated, indicates that RNAV operation is selected. RN light dimming is only available when installed with an audio control panel incorporating the annunciator lights DAY/NITE selector switch.
15. OMNI BEARING SELECTOR (OBS) - Rotates course card (12) to select desired bearing to or from a VOR station or to a selected RNAV waypoint.

Figure 1. Cessna 300 Nav/Com Set, Operating Controls and Indicators
(Sheet 2 of 3)

16. **COURSE INDEX** - Indicates selected VOR or RNAV course (bearing).
17. **COURSE DEVIATION POINTER** - Indicates deviation from selected VOR or RNAV course or localizer centerline.
18. **OFF/TO-FROM INDICATOR** - Operates only with VOR or localizer signal. OFF position (flag) indicates unusable signal. With usable VOR signal, when OFF position disappears, indicates whether selected course is TO or FROM station or waypoint. With usable localizer signal, shows TO.
19. **RECIPROCAL COURSE INDEX** - Indicates reciprocal of selected VOR or RNAV course.

**Figure 1. Cessna 300 Nav/Com Set, Operating Controls and Indicators
(Sheet 3 of 3)**

SECTION 4

NORMAL PROCEDURES

COMMUNICATIONS OPERATION:

1. COM OFF/VOL Control -- TURN ON; adjust to desired audio level.
2. XMTR SEL Switch (on audio control panel)-- SET to desired 300 NAV/COM.
3. SPEAKER PHONE Selector Switches (on audio control panel) -- SET to desired mode.
4. 5-0 Fractional MHz Selector Switch -- SELECT desired operating frequency (does not affect navigation frequencies).
5. COM Frequency Selector Knobs -- SELECT desired operating frequency.
6. SQ Control -- ROTATE counterclockwise to just eliminate background noise.
7. Mike Button:
 - a. To Transmit -- DEPRESS and SPEAK into microphone.

NOTE

Sidetone may be selected by placing the AUTO selector switch (on audio control panel) in either the SPEAKER or PHONE position, or may be eliminated by placing the AUTO selector switch in the OFF position. Adjustment of sidetone on audio control panels supplied with three transmitters cannot be accomplished externally. However, audio control panels supplied with one or two transmitters have sidetone adjustment pots that are accessible through the front of the audio control panel with a small screwdriver.

- b. To Receive -- RELEASE mike button.

NAVIGATION

NOTE

The pilot should be aware that on many Cessna airplanes equipped with the windshield mounted glide slope antenna, pilots should avoid use of 2700 ± 100 RPM on airplanes equipped with a two-bladed propeller or 1800 ± 100 RPM on airplanes equipped with a three-bladed propeller during ILS approaches to avoid oscillations of the glide slope deviation pointer caused by propeller interference.

1. COM OFF/VOL Control -- TURN ON.
2. SPEAKER/PHONE Selector Switches (on audio control panel) -- SET to desired mode.
3. NAV Frequency Selector Knobs -- SELECT desired operating frequency.
4. NAV VOL Control -- ADJUST to desired audio level.
5. ID-VOX-T Switch:
 - a. To Identify Station -- SET to ID to hear navigation station identifier (Morse Code) signal.
 - b. To Filter Out Station Identifier Signal -- SET to VOX (center) position to include filter in audio circuit.
6. OBS Knob -- SELECT desired course.

TO SELF TEST VOR NAVIGATION CIRCUITS:

1. COM OFF/VOL Control -- TURN ON.
2. NAV Frequency Selector Switches -- SELECT usable VOR station signal.
3. OBS Knob -- SET for 0° course at index; CDI pointer centers or deflects left or right, depending on bearing of signal; OFF/TO-FROM indicator shows TO or FROM.
4. ID-VOX-T Switch -- PRESS to T and HOLD at T; CDI pointer should center and OFF/TO-FROM indicator should show FROM.
5. OBS Knob -- TURN to displace course approximately 10° to either side of 0° (while holding ID-VOX-T switch at T); CDI pointer should deflect full scale in direction corresponding to course displacement. OFF/TO-FROM indicator should still show FROM.

NOTE

This test does not fulfill the requirements of FAR 91.25.

SECTION 5 PERFORMANCE

There is no change to the airplane performance when this avionic equipment is installed. However, the installation of an externally mounted antenna or several related external antennas, will result in a minor reduction in cruise performance.

SUPPLEMENT

CESSNA 300 TRANSPONDER

(Type RT-359A)

AND

OPTIONAL ALTITUDE ENCODER

(BLIND)

SECTION 1

GENERAL

The Cessna 300 Transponder (Type RT-359A), shown in Figure 1, is the airborne component of an Air Traffic Control Radar Beacon System (ATCRBS). The transponder enables the ATC ground controller to "see" and identify the aircraft, while in flight, on the control center's radarscope more readily.

The Cessna 300 Transponder system consists of a panel-mounted unit, an externally-mounted antenna and an optional control wheel-mounted XPDR IDENT switch. The transponder receives interrogating pulse signals on 1030 MHz and transmits pulse-train reply signals on 1090 MHz. The transponder is capable of replying to Mode A (aircraft identification) and also to Mode C (altitude reporting) when coupled to an optional altitude encoder system. The transponder is capable of replying on both modes of interrogation on a selective reply basis on any of 4096 information code selections. The optional altitude encoder system (not part of a standard 300 Transponder system) required for Mode C (altitude reporting) operation consists of a completely independent remote-mounted digitizer that is connected to the static system and supplies encoded altitude information to the transponder. When the altitude encoder system is coupled to the 300 Transponder system, altitude reporting capabilities are available in 100-foot increments between -1000 and +20,000 feet.

All Cessna 300 Transponder operating controls, with the exception of the optional XPDR IDENT switch, are located on the front panel of the unit. The remote XPDR IDENT switch is located on the right hand grip of the pilot's control wheel. Functions of the operating controls are described in Figure 1.

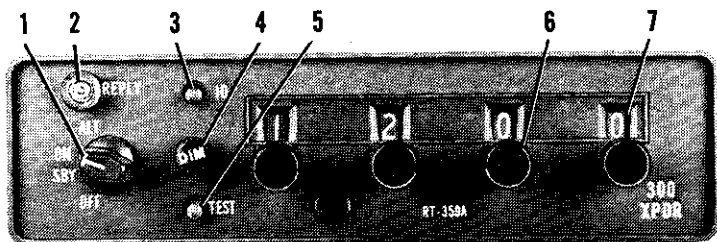

1. **FUNCTION SWITCH** - Controls application of power and selects transponder operating mode as follows:

OFF - Turns set off.

SBY - Turns set on for equipment warm-up or standby power.

ON - Turns set on and enables transponder to transmit Mode A (aircraft identification) reply pulses.

ALT - Turns set on and enables transponder to transmit either Mode A (aircraft identification) reply pulses or Mode C (altitude reporting) pulses selected automatically by the interrogating signal.

Figure 1. Cessna 300 Transponder and Altitude Encoder (Blind)
(Sheet 1 of 2)

PILOT'S OPERATING HANDBOOK CESSNA 300 TRANSPONDER
SUPPLEMENT AND ALTITUDE ENCODER (BLIND)

2. REPLY LAMP - Lamp flashes to indicate transmission of reply pulses; glows steadily to indicate transmission of IDENT pulse or satisfactory self-test operation. (Reply lamp will also glow steadily during initial warm-up period.)
3. IDENT (ID) SWITCH - When depressed, selects special pulse identifier to be transmitted with transponder reply to effect immediate identification of aircraft on ground controller's display. (Reply lamp will glow steadily during duration of IDENT pulse transmission.)
4. DIMMER (DIM) CONTROL - Allows pilot to control brilliance of reply lamp.
5. SELF-TEST (TST) SWITCH - When depressed, causes transponder to generate a self-interrogating signal to provide a check of transponder operation. (Reply lamp will glow steadily to verify self-test operation.)
6. REPLY-CODE SELECTOR KNOBS (4) - Select assigned Mode A reply code.
7. REPLY-CODE INDICATORS (4) - Display selected Mode A reply code.
8. REMOTE-MOUNTED DIGITIZER - Provides an altitude reporting code range of -1000 feet up to the airplane's maximum service ceiling.
9. REMOTE ID SWITCH (XPDR IDENT) - Same as panel-mounted ID switch described in Item 3.

Figure 1. Cessna 300 Transponder and Altitude Encoder (Blind)
(Sheet 2 of 2)

SECTION 2

LIMITATIONS

There is no change to the airplane limitations when this avionic equipment is installed. However, the following information must be displayed in the form of a placard located near the altimeter.

ALTITUDE ENCODER EQUIPPED

SECTION 3

EMERGENCY PROCEDURES

TO TRANSMIT AN EMERGENCY SIGNAL:

1. Function Switch -- ON.
2. Reply-Code Selector Knobs -- SELECT 7700 operating code.

TO TRANSMIT A SIGNAL REPRESENTING LOSS OF ALL COMMUNICATIONS (WHEN IN A CONTROLLED ENVIRONMENT):

1. Function Switch -- ON.
2. Reply-Code Selector Knobs -- SELECT 7700 operating code for 1 minute; then SELECT 7600 operating code for 15 minutes and then REPEAT this procedure at same intervals for remainder of flight.

SECTION 4

NORMAL PROCEDURES

BEFORE TAKEOFF:

1. Function Switch -- SBY.

TO TRANSMIT MODE A (AIRCRAFT IDENTIFICATION) CODES IN FLIGHT:

1. Reply-Code Selector Knobs -- SELECT assigned code.

2. Function Switch -- ON.
3. DIM Control -- ADJUST light brilliance of reply lamp.

NOTE

During normal operation with function switch in ON position, reply lamp flashes indicating transponder replies to interrogations.

4. ID or XPDR IDENT Button -- DEPRESS momentarily when instructed by ground controller to "squawk IDENT" (reply lamp will glow steadily, indicating IDENT operation).

TO TRANSMIT MODE C (ALTITUDE REPORTING) CODES IN FLIGHT:

1. Reply-Code Selector Knobs -- SELECT assigned code.
2. Function Switch -- ALT.

NOTE

When directed by ground controller to "stop altitude squawk", turn Function Switch to ON for Mode A operation only.

NOTE

Pressure altitude is transmitted by the transponder for altitude squawk and conversion to indicated altitude is done in ATC computers. Altitude squawked will only agree with indicated altitude when the local altimeter setting in use by the ground controller is set in the aircraft altimeter.

3. DIM Control -- ADJUST light brilliance of reply lamp.

TO SELF-TEST TRANSPONDER OPERATION:

1. Function Switch -- SBY and wait 30 seconds for equipment to warm-up.
2. Function Switch -- ON or ALT.
3. TST Button -- DEPRESS (reply lamp should light brightly regardless of DIM control setting).
4. TST Button -- RELEASE for normal operation.

SECTION 5

PERFORMANCE

There is no change to the airplane performance when this avionic equipment is installed. However, the installation of an externally mounted antenna or several related external antennas, will result in a minor reduction in cruise performance.

SUPPLEMENT

CESSNA 300 TRANSPONDER **(Type RT-359A)**

AND

OPTIONAL ENCODING ALTIMETER **(Type EA-401A)**

SECTION 1

GENERAL

The Cessna 300 Transponder (Type RT-359A), shown in Figure 1, is the airborne component of an Air Traffic Control Radar Beacon System (ATCRBS). The transponder enables the ATC ground controller to "see" and identify the aircraft, while in flight, on the control center's radarscope more readily.

The Cessna 300 Transponder system consists of a panel-mounted unit, an externally-mounted antenna and an optional control wheel-mounted XPDR IDENT switch. The transponder receives interrogating pulse signals on 1030 MHz and transmits pulse-train reply signals on 1090 MHz. It is capable of replying to Mode A (aircraft identification) and also to Mode C (altitude reporting) interrogations on a selective reply basis on any of 4096 information code selections. When an optional panel-mounted EA-401A Encoding Altimeter (not part of a standard 300 Transponder system) is included in the avionic configuration, the transponder can provide altitude reporting in the 100-foot increments between -1000 and +35,000 feet.

All Cessna 300 Transponder operating controls, with the exception of the optional altitude encoder's altimeter setting knob and the optional remote XPDR IDENT switch, are located on the front panel of the unit. The altimeter setting knob is located on the encoding altimeter and the remote XPDR IDENT switch is located on the right hand grip of the pilot's control wheel. Functions of the operating controls are described in Figure 1.

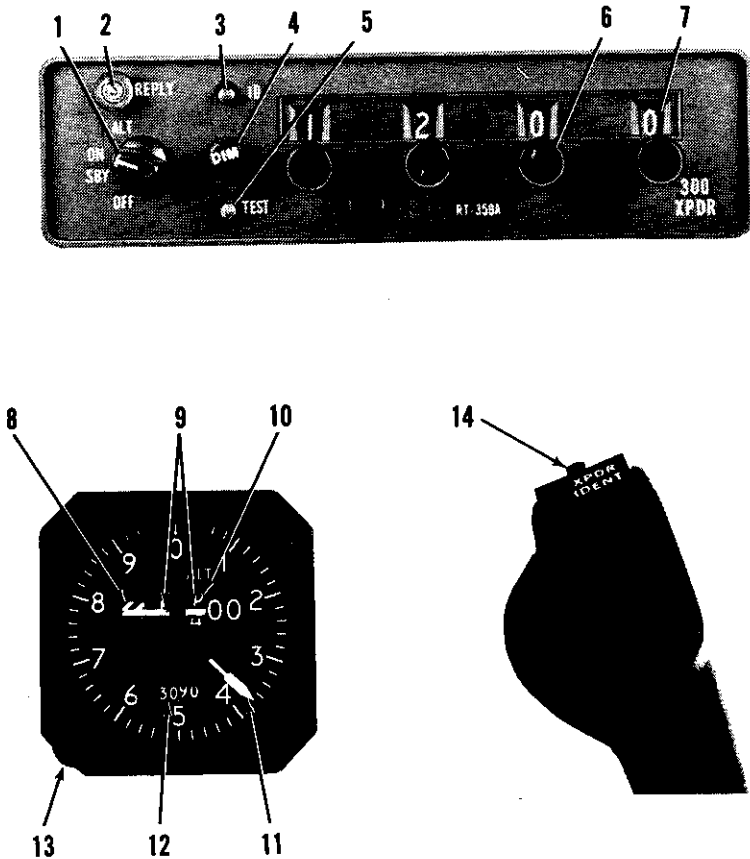

1. **FUNCTION SWITCH** - Controls application of power and selects transponder operating mode as follows:

OFF - Turns set off.

SBY - Turns set on for equipment warm-up or stand-by power.

ON - Turns set on and enables transponder to transmit Mode A (aircraft identification) reply pulses.

ALT - Turns set on and enables transponder to transmit either Mode A (aircraft identification) reply pulses or Mode C (altitude reporting) pulses selected automatically by the interrogating signal.

Figure 1. Cessna 300 Transponder and Encoding Altimeter (Sheet 1 of 2)

2. **REPLY LAMP** - Lamp flashes to indicate transmission of reply pulses; glows steadily to indicate transmission of IDENT pulse or satisfactory self-test operation. (Reply lamp will also glow steadily during initial warm-up period.)
3. **IDENT (ID) SWITCH** - When depressed, selects special pulse identifier to be transmitted with transponder reply to effect immediate identification of aircraft on ground controller's display. (Reply lamp will glow steadily during duration of IDENT pulse transmission.)
4. **DIMMER (DIM) CONTROL** - Allows pilot to control brilliance of reply lamp.
5. **SELF-TEST (TST) SWITCH** - When depressed, causes transponder to generate a self-interrogating signal to provide a check of transponder operation. (Reply lamp will glow steadily to verify self-test operation.)
6. **REPLY-CODE SELECTOR KNOBS (4)** - Select assigned Mode A reply code.
7. **REPLY-CODE INDICATORS (4)** - Display selected Mode A reply code.
8. **1000-FOOT DRUM TYPE INDICATOR** - Provides digital altitude readout in 1000-foot increments between -1000 feet and +35,000 feet. When altitude is below 10,000 feet, a diagonally striped flag appears in the 10,000 foot window.
9. **OFF INDICATOR WARNING FLAG** - Flag appears across altitude readout when power is removed from the altimeter to indicate that readout is not reliable.
10. **100-FOOT DRUM TYPE INDICATOR** - Provides digital altitude readout in 100-foot increments between 0 and 1000 feet.
11. **20-FOOT INDICATOR NEEDLE** - Indicates altitude in 20-foot increments between 0 feet and 1000 feet.
12. **ALTIMETER SETTING SCALE - DRUM TYPE** - Indicates selected altimeter setting in the range of 27.9 to 31.0 inches of mercury on the standard altimeter or 950 to 1050 millibars on the optional altimeter.
13. **ALTIMETER SETTING KNOB** - Dials in desired altimeter setting in the range of 27.9 to 31.0 inches of mercury on the standard altimeter or 950 to 1050 millibars on the optional altimeter.
14. **REMOTE ID SWITCH (XPDR IDENT)** - Same as panel-mounted ID switch described in Item 3.

Figure 1. Cessna 300 Transponder and Encoding Altimeter (Sheet 2 of 2)

SECTION 2

LIMITATIONS

There is no change to the airplane performance when this avionic equipment is installed. However, the encoding altimeter used in this installation does have a limitation that requires a standard barometric altimeter to be installed as a back-up altimeter.

SECTION 3

EMERGENCY PROCEDURES

TO TRANSMIT AN EMERGENCY SIGNAL:

1. Function Switch -- ON.
2. Reply-Code Selector Knobs -- SELECT 7700 operating code.

TO TRANSMIT A SIGNAL REPRESENTING LOSS OF ALL COMMUNICATIONS (WHEN IN A CONTROLLED ENVIRONMENT):

1. Function Switch -- ON.
2. Reply-Code Selector Knobs -- SELECT 7700 operating code for 1 minute; then SELECT 7600 operating code for 15 minutes and then REPEAT this procedure at same intervals for remainder of flight.

SECTION 4

NORMAL PROCEDURES

BEFORE TAKEOFF:

1. Function Switch -- SBY.

TO TRANSMIT MODE A (AIRCRAFT IDENTIFICATION) CODES IN FLIGHT:

1. Reply-Code Selector Knobs -- SELECT assigned code.

2. Function Switch -- ON.
3. DIM Control -- ADJUST light brilliance of reply lamp.

NOTE

During normal operation with function switch in ON position, reply lamp flashes indicating transponder replies to interrogations.

4. ID or XPDR IDENT Button -- DEPRESS momentarily when instructed by ground controller to "squawk IDENT" (reply lamp will glow steadily, indicating IDENT operation).

TO TRANSMIT MODE C (ALTITUDE REPORTING) CODES IN FLIGHT:

1. Off Indicator Warning Flag -- VERIFY that flag is out of view on encoding altimeter.
2. Altitude Encoder Altimeter Setting Knob -- SET IN assigned local altimeter setting.
3. Reply-Code Selector Knobs -- SELECT assigned code.
4. Function Switch -- ALT.

NOTE

When directed by ground controller to "stop altitude squawk", turn Function Switch to ON for Mode A operation only.

NOTE

Pressure altitude is transmitted by the transponder for altitude squawk and conversion to indicated altitude is done in ATC computers. Altitude squawked will only agree with indicated altitude when the local altimeter setting in use by the ground controller is set in the encoding altimeter.

5. DIM Control -- ADJUST light brilliance of reply lamp.

TO SELF-TEST TRANSPONDER OPERATION:

1. Function Switch -- SBY and wait 30 seconds for equipment to warm-up.
2. Function Switch -- ON or ALT.

3. TST Button -- DEPRESS and HOLD (reply lamp should light with full brilliance regardless of DIM control setting).
4. TST Button -- RELEASE for normal operation.

SECTION 5 PERFORMANCE

There is no change to the airplane performance when this avionic equipment is installed. However, the installation of an externally mounted antenna or several related external antennas, will result in a minor reduction in cruise performance.

SUPPLEMENT

CESSNA NAVOMATIC 300A AUTOPILOT (Type AF-395A)

SECTION 1 GENERAL

The Cessna 300A Navomatic is an all electric, single-axis (aileron control) autopilot system that provides added lateral and directional stability. Components are a computer-amplifier, a turn coordinator, a directional gyro, an aileron actuator and a course deviation indicator(s) incorporating a localizer reversed (BC) indicator light.

Roll and yaw motions of the airplane are sensed by the turn coordinator gyro. Deviations from the selected heading are sensed by the directional gyro. The computer-amplifier electronically computes the necessary correction and signals the actuator to move the ailerons to maintain the airplane in the commanded lateral attitude or heading.

The 300A Navomatic will also intercept and track a VOR or localizer course using signals from a VHF navigation receiver.

The operating controls for the Cessna 300A Navomatic are located on the front panel of the computer-amplifier and on the directional gyro, shown in Figure 1. The primary function pushbuttons (HDG SEL, NAV INT, and NAV TRK), are interlocked so that only one function can be selected at a time. The HI SENS and BACK CRS pushbuttons are not interlocked so that either or both of these functions can be selected at any time.

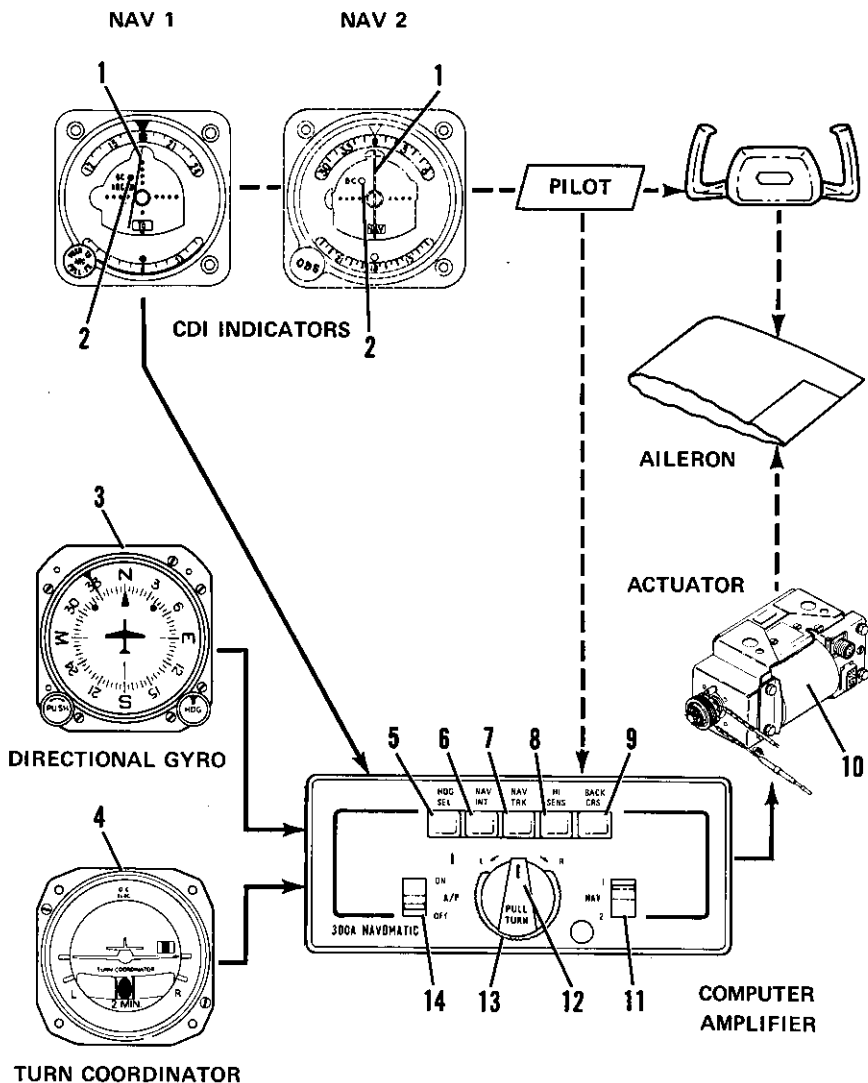

Figure 1. Cessna 300A Autopilot, Operating Controls and Indicators
 (Sheet 1 of 2)

1. COURSE DEVIATION INDICATOR - Provides VOR/LOC navigation inputs to autopilot for intercept and tracking modes.
2. LOCALIZER REVERSED INDICATOR LIGHT - Amber light, labeled BC, illuminates when BACK CRS button is pushed in (engaged) and LOC frequency selected. BC light indicates course indicator needle is reversed on selected receiver (when tuned to a localizer frequency). This light is located within the CDI indicator.
3. DIRECTIONAL GYRO INDICATOR - Provides heading information to the autopilot for heading intercept and hold. Heading bug on indicator is used to select desired heading or VOR/LOC course to be flown.
4. TURN COORDINATOR - Senses roll and yaw for wings leveling and command turn functions.
5. HDG SEL PUSHBUTTON - Aircraft will turn to and hold heading selected by the heading "bug" on the directional gyro.
6. NAV INT PUSHBUTTON - When heading "bug" on DG is set to selected course, aircraft will turn to and intercept selected VOR or LOC course.
7. NAV TRK PUSHBUTTON - When heading "bug" on DG is set to selected course, aircraft will track selected VOR or LOC course.
8. HI SENS PUSHBUTTON - During NAV INT or NAV TRK operation, this high sensitivity setting increases autopilot response to NAV signal to provide more precise operation during localizer approach. In low-sensitivity position (pushbutton out), response to NAV signal is dampened for smoother tracking of enroute VOR radials; it also smooths out effect of course scalloping during NAV operation.
9. BACK CRS PUSHBUTTON - Used with LOC operation only. With A/P switch OFF or ON, and when navigation receiver selected by NAV switch is set to a localizer frequency, it reverses normal localizer needle indication (CDI) and causes localizer reversed (BC) light to illuminate. With A/P switch ON, reverses localizer signal to autopilot.
10. ACTUATOR - The torque motor in the actuator causes the ailerons to move in the commanded direction.
11. NAV SWITCH - Selects NAV 1 or NAV 2 navigation receiver.
12. PULL TURN KNOB - When pulled out and centered in detent, airplane will fly wings-level; when turned to the right (R), the airplane will execute a right, standard rate turn; when turned to the left (L), the airplane will execute a left, standard rate turn. When centered in detent and pushed in, the operating mode selected by a pushbutton is engaged.
13. TRIM - Used to trim autopilot to compensate for minor variations in aircraft trim or lateral weight distribution. (For proper operation, the aircraft's rudder trim, if so equipped, must be manually trimmed before the autopilot is engaged.)
14. A/P SWITCH - Turns autopilot ON or OFF.

Figure 1. Cessna 300A Autopilot, Operating Controls and Indicators
(Sheet 2 of 2)

SECTION 2

LIMITATIONS

The following autopilot limitation must be adhered to:

BEFORE TAKE-OFF AND LANDING:

1. A/P ON-OFF Switch -- OFF.

SECTION 3

EMERGENCY PROCEDURES

TO OVERRIDE THE AUTOPILOT:

1. Airplane Control Wheel -- ROTATE as required to override autopilot.

NOTE

The servo may be overpowered at any time without damage.

TO TURN OFF AUTOPILOT:

1. A/P ON-OFF Switch -- OFF.

SECTION 4

NORMAL PROCEDURES

BEFORE TAKE-OFF AND LANDING:

1. A/P ON-OFF Switch -- OFF.
2. BACK CRS Button -- OFF (see Caution note under Nav Intercept).

NOTE

Periodically verify operation of amber warning light(s), labeled BC on CDI(s), by engaging BACK CRS button with a LOC frequency selected.

INFLIGHT WINGS LEVELING:

1. Airplane Rudder Trim -- ADJUST for zero slip ("Ball" centered on Turn Coordinator).
2. PULL-TURN Knob -- CENTER and PULL out.
3. A/P ON-OFF Switch -- ON.
4. Autopilot TRIM Control -- ADJUST for zero turn rate (wings level indication on Turn Coordinator).

NOTE

For optimum performance in airplanes equipped as float-planes, use autopilot only in cruise flight or in approach configuration with flaps down no more than 10° and airspeed no lower than 75 KIAS on 172 and R172 Series Models or 90 KIAS on 180, 185, U206 and TU206 Series Models.

COMMAND TURNS:

1. PULL-TURN Knob -- CENTER, PULL out and ROTATE.

HEADING SELECT:

1. Directional Gyro -- SET to airplane magnetic heading.
2. Heading Selector Knob -- ROTATE bug to desired heading.
3. Heading Select Button -- PUSH.
4. PULL-TURN Knob -- CENTER and PUSH.

NOTE

Airplane will turn automatically to selected heading. If airplane fails to hold the precise heading, readjust autopilot TRIM control as required or disengage autopilot and reset manual rudder trim (if installed).

NAV INTERCEPT (VOR/LOC):

1. PULL-TURN Knob -- CENTER and PULL out.
2. NAV 1-2 Selector Switch -- SELECT desired receiver.
3. Nav Receiver OBS or ARC Knob -- SET desired VOR course (if tracking omni).

NOTE

Optional ARC knob should be in center position and ARC warning light should be off.

4. Heading Selector Knob -- ROTATE bug to selected course (VOR or localizer - inbound or outbound as appropriate).
5. Directional Gyro -- SET for magnetic heading.
6. NAV INT Button -- PUSH.
7. HI SENS Button -- PUSH for localizer and "close-in" omni intercepts.
8. BACK CRS Button -- PUSH only if intercepting localizer front course outbound or back course inbound.

CAUTION

With BACK CRS button pushed in and localizer frequency selected, the CDI on selected nav radio will be reversed even when the autopilot switch is OFF.

9. PULL-TURN Knob -- PUSH.

NOTE

Airplane will automatically turn to a 45° intercept angle.

NAV TRACKING (VOR/LOC):

1. NAV TRK Button -- PUSH when CDI centers (within one dot) and airplane is within $\pm 10^\circ$ of course heading.
2. HI SENS Button -- Disengage for enroute omni tracking (leave engaged for localizer).

NOTE

Optional ARC feature, if installed, should not be used for autopilot operation. If airplane should deviate off course, pull out PULL TURN knob and readjust airplane rudder trim for straight flight on the turn coordinator. Push in PULL TURN knob and reintercept the course. If deviation persists, progressively make slight adjustments of the autopilot TRIM control towards the course as required to maintain track.

SECTION 5 PERFORMANCE

There is no change to the airplane performance when this avionic equipment is installed.

SUPPLEMENT

CESSNA 400 ADF (Type R-446A)

SECTION 1 GENERAL

The Cessna 400 ADF is an automatic direction finder set which provides continuous, visual bearing indications of the direction from which an RF signal is being received. It can be used for plotting position, for homing, and for aural reception of AM signals between 200 kHz and 1699 kHz. In addition, a crystal-controlled, beat frequency oscillator (BFO) permits coded identifier of stations transmitting keyed CW signals (Morse Code) to be heard.

The basic units of the Cessna 400 ADF are a R-446A Receiver with dual frequency selectors, a goniometer-indicator (IN-346A), a sense antenna and a loop antenna. The receiver and goniometer-indicator are panel-mounted units. The sense and loop antennas are mounted on the external airplane surfaces. The goniometer indicator presents station bearing in degrees of azimuth. An automatic pointer-stow feature alerts the operator to non-ADF operation by slewing the pointer to the 3:00 o'clock position when the REC mode is selected. Operating controls and displays for the Cessna 400 ADF are shown and described in Figure 1. The audio control panels used in conjunction with this radio for speaker-phone selection are shown and described in Section 7 of this handbook.

The frequency range of the Cessna 400 ADF is electronically divided into three bands: 200-399 kHz, 400-799 kHz, and 800-1699 kHz. Frequency spacing within each band is in 1-kHz increments. The operating frequency and band are selected by a four-section Minilever switch which displays a digital readout of the frequency selected and supplies a binary code to control the logic circuits within the set. A secondary (standby) operating frequency is selected by another four-section Minilever switch. Frequency control of the ADF is switched to the primary or the secondary operating frequency by a toggle switch. The operating modes (ADF and REC) are selected by individual pushbutton switches. Additional pushbutton switches are used to select the BFO and to test signal reliability during ADF operation.

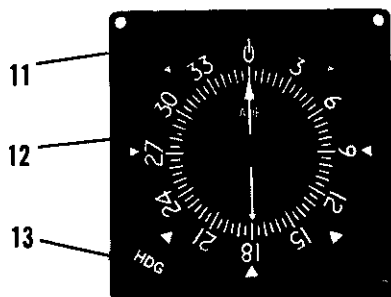
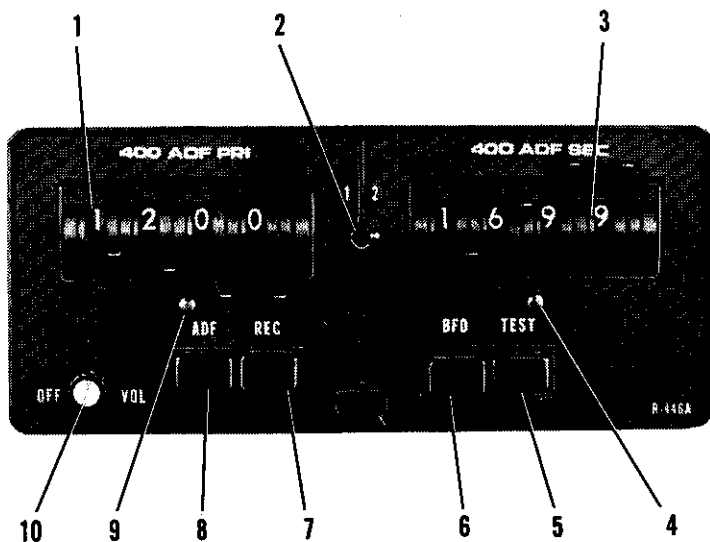

Figure 1. Cessna 400 ADF Operating Controls and Indicator
(Sheet 1 of 2)

1. PRI (PRIMARY FREQUENCY SELECTOR) - Selects and displays "primary" frequency.
2. 1-2 - The "1" position activates "primary" (PRI) frequency. The "2" position activates "secondary" (SEC) frequency.
3. SEC (SECONDARY FREQUENCY SELECTOR) - Selects and displays "secondary" frequency.
4. SECONDARY RESELECT LAMP - Lamp will flash only when "secondary" (SEC) frequency selection is outside of operating range of the receiver and 1-2 switch is in the "2" position.
5. TEST - Momentary-on switch used only with ADF function to test bearing reliability. When held depressed, slews indicator pointer; when released, if bearing is reliable, pointer returns to original position.
6. BFO - Pushed in: Activates beat frequency oscillator tone to permit coded identifier of stations transmitting keyed CW signals (Morse Code) to be heard.
7. REC - Pushed in: Selects receive mode (set operates as a standard communications receiver using sense antenna only).

NOTE

In this position an automatic pointer stow feature will alert the pilot to non-ADF operation by positioning and retaining the pointer at the 3:00 o'clock position when the 400 ADF is in the REC function.

8. ADF - Pushed in: Selects ADF mode (set operates as automatic direction finder using loop and sense antennas).
9. PRIMARY RESELECT LAMP - Lamp will flash only when "primary" (PRI) frequency selection is outside of operating range of the receiver and 1-2 switch is in the "1" position.
10. OFF-VOL - Turns set on or off and adjusts receiver volume.
11. INDEX - Fixed reference line for dial rotation adjustment.
12. POINTER - When HDG control is adjusted, indicates either relative, magnetic, or true bearings of a radio station.
13. HDG - Rotates dial to facilitate relative, magnetic, or true bearing information.

Figure 1. Cessna 400 ADF Operating Controls and Indicator
(Sheet 2 of 2)

SECTION 2

LIMITATIONS

There is no change to the airplane limitations when this avionic equipment is installed.

SECTION 3

EMERGENCY PROCEDURES

There is no change to the airplane emergency procedures when this avionic equipment is installed.

SECTION 4

NORMAL PROCEDURES

TO OPERATE AS A COMMUNICATIONS RECEIVER ONLY:

1. OFF/VOL Control -- ON.
2. REC Pushbutton -- PUSH in.

NOTE

ADF indicator pointer will stow at a 90-degree position to alert the pilot to non-ADF operation.

3. PRI Frequency Selectors -- SELECT desired operating frequency.
4. SEC Frequency Selectors -- SELECT desired operating frequency.
5. 1-2 Selector Switch -- 1 position.

NOTE

1-2 selector switch can be placed in the 2 position for operation on secondary frequency. The re-select lamp will flash only when frequency selection is outside of operating range of the receiver.

6. ADF SPEAKER/PHONE Selector Switch (on audio control panel) -- SELECT speaker or phone position.
7. VOL Control -- ADJUST to desired listening level.

TO OPERATE AS AN AUTOMATIC DIRECTION FINDER:

1. OFF/VOL Control -- ON.
2. PRI Frequency Selectors -- SELECT desired operating frequency.
3. SEC Frequency Selectors -- SELECT desired operating frequency.
4. 1-2 Selector Switch -- 1 position.

NOTE

1-2 selector switch can be placed in the 2 position for operation on secondary frequency. The re-select lamp will flash only when frequency selection is outside of operating range of the receiver.

5. ADF SPEAKER/PHONE Selector Switch (on audio control panel) -- SELECT speaker or phone position as desired.
6. ADF Pushbutton -- PUSH in and note relative bearing on ADF indicator.
7. HDG Control -- SET goniometer-indicator dial so that index indicates 0°, magnetic, or true heading of airplane. Pointer then indicates relative, magnetic, or true bearing to station.
8. VOL Control -- ADJUST to desired listening level.

NOTE

When switching stations, place function pushbutton in the REC position. Then, after station has been selected, place function pushbutton in the ADF position to resume automatic direction finder operation. (This practice prevents the bearing indicator from swinging back and forth as frequency dial is rotated.)

TO TEST RELIABILITY OF AUTOMATIC DIRECTION FINDER:

1. ADF Pushbutton -- PUSH in and note relative bearing on indicator.
2. TEST Pushbutton -- PUSH in and hold TEST button until indicator pointer slews off indicated bearing at least 10 to 20 degrees.
3. TEST Pushbutton -- RELEASE and OBSERVE that indicator pointer returns to the same relative bearing as in step (1).

TO OPERATE BFO:

1. OFF/VOL Control -- ON.
2. ADF SPEAKER/PHONE Selector Switch (on audio control panel) -- SELECT speaker or phone position as desired.
3. BFO Pushbutton -- PUSH in.
4. 1-2 Selector Switch -- SELECT 1 position to activate PRI frequency

- or 2 to activate SEC frequency that is transmitting keyed CW signals (Morse Code).
5. VOL Control -- ADJUST to desired listening level.

NOTE

A 1000-Hz tone is heard in the audio output when CW signal (Morse Code) is tuned in properly.

SECTION 5 PERFORMANCE

There is no change to the airplane performance when this avionic equipment is installed. However, the installation of an externally mounted antenna or several related external antennas, will result in a minor reduction in cruise performance.

SUPPLEMENT

CESSNA 400 AREA NAVIGATION SYSTEM

(Type RN-478A)

SECTION 1 GENERAL

The Cessna 400 Area Navigation System (Type RN-478A) consists of an RN-478A Area NAV Computer (RNAV), a compatible VHF navigation receiver and course deviation indicator, and the Type R-476A distance measuring equipment (DME). The RNAV includes converter circuits which operate with the VHF navigation receiver and produce positional information for display by the course deviation indicator. It also includes computer circuits which combine the bearing information from the navigation set with the distance information from the R-476A DME to establish navigation data for selected waypoints. During RNAV operation, a course scalloping suppressor circuit suppresses the spurious navigation signal phases to provide stable waypoint information which enhances autopilot operation. The 400 RNAV is coupled to the number 2 Nav/Com and includes storage for 3 waypoints.

Ground speed/time-to-station information to the selected VOR (not the waypoint) is available on this system. This capability, along with the course scalloping suppression (radial straightening), may be used to an advantage while tracking inbound or outbound from the VOR station by programming a waypoint directly over the associated VOR (000.0°/000.0 nautical miles) and using RNAV for course smoothing while enroute.

CAUTION

If RNAV set is removed from the airplane or becomes inoperative, the associated VHF navigation indicator will be inoperative.

All operating controls and displays which are part of the RN-478A are shown and described in Figure 1. Other controls required for operation of the Cessna 400 Area Navigation System are included on the VHF navigation receiver and on the R-476A DME control; these controls are shown and described in the respective supplements included for this equipment.

SECTION 2 LIMITATIONS

The following RNAV IFR approach limitation must be adhered to during airplane operation.

OPERATING LIMITATION:

1. IFR Approaches -- Follow approved published RNAV instrument procedures.

SECTION 3 EMERGENCY PROCEDURES

There is no change to the airplane emergency procedures when this avionic equipment is installed.

SECTION 4 NORMAL PROCEDURES

VOR/LOC OPERATION

VOR NAVIGATION CIRCUITS VERIFICATION TESTS:

1. See appropriate Nav/Com supplement.

VOR/LOC NAVIGATION:

As a convenience to the pilot, a separate supplement (Avionic Operation Guide) is supplied to explain the various procedures for using the VHF Navigation Set for VOR and localizer navigation. Refer to the Avionic Operations Guide for flight procedures.

AREA NAVIGATION OPERATION

NOTE

Proper RNAV operation requires valid VOR and DME inputs to the RNAV system. In certain areas, the ground station antenna patterns and transmitter power may be inadequate to provide valid signals to the RNAV. For this

reason, intermittent RNAV signal loss may be experienced enroute. Prolonged loss of RNAV signal shall require the pilot to revert to other navigational procedures.

WAYPOINT PROGRAMMING:

1. Using a VFR sectional, enroute instrument chart, instrument approach plate, or enroute RNAV chart -- DETERMINE distance and bearing for desired waypoint(s) from appropriate VOR/DME stations.
2. VHF Navigation Receiver -- ON.
3. DME TEST/ON-OFF Switch -- ON.
4. DME Mode Selector Switch -- RNAV.
5. RNAV DSPL Switch -- 1.

NOTE

When DSPL and FLY switches are not set to the same waypoint number, the display/fly light slowly blinks on and off as a reminder to the pilot that values displayed are not those being used for navigation. This does not affect operation of the unit.

6. BEARING Minilever Switches -- SET to first waypoint bearing.
7. DISTANCE Minilever Switches -- SET to first waypoint distance.
8. XFER Pushbutton Switch -- PUSH in.
 - a. First waypoint bearing and distance are placed in memory as waypoint 1.
 - b. BEARING Display Readout -- DISPLAYS readout of first waypoint bearing.
 - c. DISTANCE Display Readout -- DISPLAYS readout of first waypoint distance.
9. RNAV DSPL Switch -- SET to 2.
10. BEARING Minilever Switches -- SET to second waypoint bearing.
11. DISTANCE Minilever Switches -- SET to second waypoint distance.
12. XFER Pushbutton Switch -- PUSH in.
 - a. Second Waypoint Readout -- BEARING and DISTANCE are placed in memory as waypoint 2.
 - b. BEARING Display Readout -- DISPLAYS readout of second waypoint bearing.
 - c. DISTANCE Display Readout -- DISPLAYS readout of second waypoint distance.
13. BEARING Minilever Switches -- SET to standby waypoint bearing.

14. DISTANCE Minilever Switches -- SET to standby waypoint distance.

NOTE

As first waypoint is reached, it can be replaced with the third "standby" waypoint (already set) before placing the RNAV "DSPL" switch to 2. Then a fourth waypoint, if necessary, can be set with the minilever selectors.

DISPLAY RELIABILITY TESTS:

NOTE

This test must be conducted following the "Waypoint Programming" procedures with the VHF Navigation Receiver and DME TEST/ON-OFF switches still in the ON position.

1. VHF Navigation Receiver Frequency Selector Switches -- SET to VOR frequency.
2. RNAV DSPL and FLY Switches -- DSPL set to 1, FLY set to 2.
 - a. Readout -- DISPLAYS first waypoint bearing and distance that was selected in Waypoint Programming.
 - b. Fly/Display Lamp (On RNAV Control Head) -- FLASHES.
3. RNAV DSPL and FLY Switches -- DSPL set to 2, FLY set to 1.
 - a. Readout -- DISPLAYS second waypoint bearing and distance.
 - b. Fly/Display Lamp (On RNAV Control Head) -- FLASHES.
4. RNAV DSPL and FLY Switches -- BOTH SET to same number.
 - a. Readout -- DISPLAYS waypoint bearing and distance as selected by DSPL switch.
 - b. Fly/Display Lamp (On RNAV Control Head) -- NOT LIGHTED.
5. DME Mode Selector Switch -- SET to RNAV.
 - a. Both RN and NM Annunciators on DME -- LIGHTED.
 - b. RN Lamp on Course Deviation Indicator -- LIGHTS.
6. VHF Navigation Receiver Frequency Selector Switches -- SET to LOC frequency.
 - a. Both RN and NM Annunciators -- LIGHTED.
 - b. RN Lamp on Course Deviation Indicator -- LIGHTED.
 - c. Course Deviation Indicator OFF(or NAV)/TO-FROM Indicator -- OFF (or NAV) flag in view.
7. DME Mode Selector Switch -- SET to NAV 1, NAV 2, or HOLD.
 - a. NM Annunciator on DME -- LIGHTED.
 - b. RN Annunciator on DME -- NOT LIGHTED.
 - c. RN Lamp on Course Deviation Indicator -- NOT LIGHTED.
 - d. Course Indicator OFF(or NAV)/TO-FROM Indicator -- Shows TO if a usable signal is received.

8. DME Mode Selector Switch -- RNAV.
9. DME TEST/ON-OFF Switch -- HOLD to TEST.
 - a. DME RN/NM Distance Display -- READOUT is 888.8.
 - b. DME KTS/MIN Ground Speed/Time-to-Station Display -- READOUT is 888.
 - c. RNAV BEARING Display -- READOUT is 888.8.
 - d. RNAV DISTANCE Display -- READOUT is 188.8.

AREA NAVIGATION CIRCUITS SELF-TEST:

1. VHF Navigation Receiver -- ON.
2. VHF Navigation Receiver Frequency Selector Switches -- SET to a usable VOR/DME frequency.
3. DME TEST/ON-OFF Switch -- ON.
4. DME Mode Selector Switch -- RNAV.
 - a. RN Lamp on Course Deviation Indicator -- LIGHTED.
5. RNAV Computer -- PROGRAMMED to waypoint.
6. DSPL and FLY Switches -- SET both to waypoint to be tested.
 - a. BEARING Display -- READOUT is waypoint bearing.
 - b. DISTANCE Display -- READOUT is waypoint distance.
 - c. Course Indicator -- RN LAMP lights.
7. Course Indicator OBS (or ARC) -- SET to waypoint bearing.
8. VHF Navigation Receiver ID/VOX/T Switch -- HOLD in T position.
 - a. Course Deviation Pointer -- CENTERS.
 - b. Course Deviation Indicator OFF(or NAV)/TO-FROM Flag -- Shows TO.
 - c. DME Distance Display -- READOUT is the same as the RNAV DISTANCE readout.

NOTE

After releasing the navigation receiver test (T) switch, the return to accurate computed bearing and distance data can take up to 60 seconds depending upon airplane position and waypoint.

SECTION 5 PERFORMANCE

There is no change to the airplane performance when this avionics equipment is installed. However, the installation of an externally mounted antenna or several related external antennas, will result in a minor reduction in cruise performance.

SUPPLEMENT

CESSNA 400 DME

(TYPE R-476A)

SECTION 1

GENERAL

The Cessna 400 DME (Type R-476A) is the airborne "interrogator" portion of a navigation system which supplies continuous, accurate, slant range distance information from a fixed ground station to an aircraft in flight.

Except for selection of the operating channel, which is selected by the VHF navigation receiver frequency selector switches, the Cessna 400 DME is capable of independent operation. The equipment consists of a panel-mounted C-476A Control Unit which contains all of the operating controls and displays, and a remotely mounted RTA-476A Receiver-Transmitter. The RTA-476A transmits interrogating pulse pairs on 200 channels between 1041 MHz and 1150 MHz; it receives associated ground-to-air replies between 978 MHz and 1213 MHz. The C-476A Control Unit digitally displays distances up to 200 nautical miles and either ground speed or time-to-station information, as selected. All operating controls and displays for the DME are shown in Figure 1, and the functions of each are described.

SECTION 2

LIMITATIONS

There is no change to the airplane limitations when this avionic equipment is installed.

SECTION 3

EMERGENCY PROCEDURES

There is no change to the airplane emergency procedures when this avionic equipment is installed.

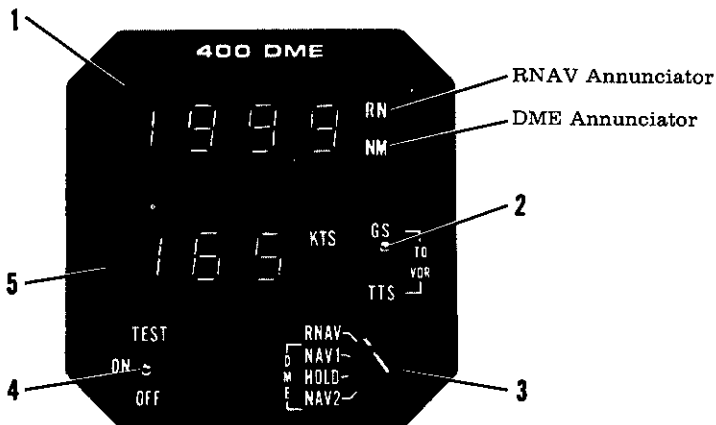

1. **DISTANCE DISPLAY** - In NAV 1, NAV 2, or HOLD mode, displays distance to selected VOR/DME station in nautical miles; only NM (Nautical Miles) annunciator lights. In RNAV mode, displays distance to selected waypoint in nautical miles; both RN (RNAV) and NM annunciators light.
2. **GS/TTS SELECTOR SWITCH** - In NAV 1, NAV 2, or HOLD mode, selects display of ground speed (GS) or time-to-station (TTS). In RNAV mode, display shows ground speed component to or from the VOR (not to waypoint) or the time to the VOR station at that indicated ground speed.
3. **DME MODE SELECTOR SWITCH** - Selects DME operating mode as follows:
 - RNAV:** Selects area navigation operation; selects display of nautical miles (distance) to selected RNAV waypoint.
 - NAV 1:** Selects DME operation with No. 1 VHF navigation set; enables channel selection by NAV 1 frequency selector switches.
 - HOLD:** Selects DME memory circuit; DME remains channeled to station to which it was channeled when HOLD was selected; display of distance continues to be nautical miles to that station. Both the NAV 1 and the NAV 2 sets may be set to new operation frequencies.

CAUTION

In the HOLD mode, there is no annunciation of the VOR/DME station frequency.

NAV 2: Selects DME operation with No. 2 VHF navigation set; enables channel selection by NAV 2 frequency selector switches.

Figure 1. Cessna 400 DME (Type R-476A) (Sheet 1 of 2)

4. **TEST/ON-OFF SWITCH** - Controls application of power to DME circuits (turns equipment on or off); selects display lamp test for DME and RNAV displays.
5. **GROUND SPEED/TIME DISPLAY** - Displays ground speed in knots or time-to-station in minutes, as follows:
 - a. With GS/TTS Switch set to GS, displays ground speed component to or from station in knots (aircraft must be flying directly to or from the VOR/DME station for true ground speed indication).
 - b. With GS/TTS Switch set to TTS, displays time to VOR/DME station in minutes at the ground speed component indicated.
 - c. With GS/TTS in RNAV mode will display ground speed component or time-to-station at that speed to the selected VOR (not the waypoint).

Figure 1. Cessna 400 DME (Type R-476A) (Sheet 2 of 2)

SECTION 4

NORMAL PROCEDURES

DME OPERATION:

1. TEST/ON-OFF Switch -- SET to ON.
2. DME Mode Selector Switch -- SET to NAV 1 or NAV 2.
3. NAV 1 and NAV 2 VHF Navigation Receivers -- ON; SET FREQUENCY selector switches to VOR/DME station frequencies, as required.

NOTE

When the VOR frequency is selected, the appropriate DME frequency is automatically channeled. Therefore, the system does not provide independent operation of the DME for reception of the DME Morse Code identifier.

4. DME SPEAKER/PHONE Selector Switch (on audio control panel) -- SET to desired mode.
5. GS/TTS Switch -- SET as desired.
6. TEST/ON-OFF Switch -- HOLD to TEST:
 - a. Distance-to-Station Display readout is 188.8.
 - b. Knots/Minutes Display readout is 888.
7. TEST/ON-OFF Switch -- RELEASE to ON; display readouts return to normal.

SECTION 5

PERFORMANCE

There is no change to the airplane performance when this avionic equipment is installed. However the installation of an externally mounted antenna or several related external antennas, will result in a minor reduction in cruise performance.

SUPPLEMENT
CESSNA 400 GLIDE SLOPE
(Type R-443B)

SECTION 1
GENERAL

The Cessna 400 Glide Slope is an airborne navigation receiver which receives and interprets glide slope signals from a ground-based Instrument Landing System (ILS). It is used with the localizer function of a VHF navigation system when making instrument approaches to an airport. The glide slope provides vertical path guidance while the localizer provides horizontal track guidance.

The Cessna 400 Glide Slope system consists of a remote-mounted receiver coupled to an existing navigation system, a panel-mounted indicator and an externally mounted antenna. The glide slope receiver is designed to receive ILS glide slope signals on any of 40 channels. The channels are spaced 150 kHz apart and cover a frequency range of 329.15 MHz through 335.0 MHz. When a localizer frequency is selected on the NAV receiver, the associated glide slope frequency is selected automatically.

Operation of the Cessna 400 Glide Slope system is controlled by the associated navigation system. The functions and indications of typical 300 series glide slope indicators are pictured and described in Figure 1. The 300 series glide slope indicators shown in Figure 1 depict typical indications for Cessna-crafted glide slope indicators. However, refer to the 400 Nav/Com or HSI write-ups if they are listed in this section as options for additional glide slope indicators.

SECTION 2
LIMITATIONS

There is no change to the airplane limitations when this avionic equipment is installed.

TYPICAL 300 SERIES GLIDE SLOPE INDICATORS

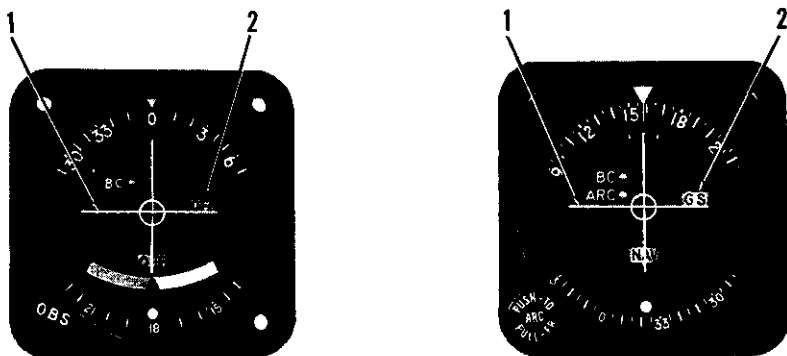

1. GLIDE SLOPE DEVIATION POINTER - Indicates deviation from normal glide slope.
2. GLIDE SLOPE "OFF" OR "GS" FLAG - When visible, indicates unreliable glide slope signal or improperly operating equipment. The flag disappears when a reliable glide slope signal is being received.

CAUTION

Spurious glide slope signals may exist in the area of the localizer back course approach which can cause the glide slope "OFF" or "GS" flag to disappear and present unreliable glide slope information. Disregard all glide slope signal indications when making a localizer back course approach unless a glide slope (ILS BC) is specified on the approach and landing chart.

Figure 1. Typical 300 Series VOR/LOC/ILS Indicator

SECTION 3 EMERGENCY PROCEDURES

There is no change to the airplane emergency procedures when this avionic equipment is installed.

SECTION 4 NORMAL PROCEDURES

TO RECEIVE GLIDE SLOPE SIGNALS:

NOTE

The pilot should be aware that on many Cessna airplanes equipped with the windshield mounted glide slope antenna, pilots should avoid use of 2700 \pm 100 RPM on airplanes equipped with a two-bladed propeller or 1800 \pm 100 RPM on airplanes equipped with a three-bladed propeller during ILS approaches to avoid oscillations of the glide slope deviation pointer caused by propeller interference.

1. NAV Frequency Select Knobs -- SELECT desired localizer frequency (glide slope frequency is automatically selected).
2. NAV/COM VOX-ID-T Switch -- SELECT ID position to disconnect filter from audio circuit.
3. NAV VOL Control -- ADJUST to desired listening level to confirm proper localizer station.

CAUTION

When glide slope "OFF" or "GS" flag is visible, glide slope indications are unusable.

SECTION 5 PERFORMANCE

There is no change to the airplane performance when this avionic equipment is installed.

SUPPLEMENT

CESSNA 400 MARKER BEACON (Type R-402A)

SECTION 1 GENERAL

The system consists of a remote mounted 75 MHz marker beacon receiver, an antenna which is either flush mounted or externally mounted on the under side of the aircraft and operating controls and annunciator lights which are mounted on the front of the audio control panel.

Operating controls for the marker beacon system are supplied on the front of the two types of audio control panels used in this Cessna aircraft. The operating controls for the marker beacon are different on the two audio control panels. One type of audio control panel is supplied with one or two transmitters and the other is supplied with three transmitters.

The marker beacon operating controls and annunciator lights used on the audio control panel supplied with two or less transmitters are shown and described in Figure 1. The operating controls consist of three, three-position toggle switches. One switch is labeled "HIGH/LO/MUTE" and provides the pilot with HIGH-LO sensitivity selection and marker beacon audio muting, for approximately 30 seconds, to enable voice communication to be heard without interference of marker beacon signals. The marker beacon audible tone is automatically restored at the end of the 30 second muting period to continue marker audio for passage over the next marker. Another switch is labeled "SPKR/OFF/PHN" and is used to turn the set on and select the desired speaker or phone position for marker beacon signals. The third toggle switch labeled, "ANN LT", is provided to enable the pilot to select the desired DAY or NITE lighting position for annunciator lights, and also a "TEST" position to verify operation of marker beacon annunciator lights.

The marker beacon operating controls and annunciator lights used on the audio control panel supplied with three transmitters are shown and described in Figure 2. The operating controls consist of two, three-position toggle switches, and two concentric control knobs. One switch is labeled "SPKR/PHN" and is used to select the desired speaker or phone position for marker beacon signals. The other switch is labeled "HI/LO/TEST" and

provides the pilot with HI-LO sensitivity selection and a TEST position to verify operation of all annunciator lights. The small, inner control knob labeled OFF/VOL, turns the set on or off and adjusts the audio listening level. The large, outer control knob labeled BRT, provides light dimming for the marker beacon lights.

When the Cessna 400 Marker Beacon controls are incorporated in an audio control panel incorporated with two or less transmitters a marker Beacon audio level adjustment potentiometer and an annunciator lights minimum dimming potentiometer are mounted on the audio control panel circuit board. Potentiometer adjustments cannot be accomplished externally. However, if readjustments are desired, adjustments can be made in accordance with instructions found in the Avionics Installations Service/Parts Manual for this aircraft.

MARKER FACILITIES

MARKER	IDENTIFYING TONE	LIGHT*
Inner & Fan	Continuous 6 dots/sec (300 Hz)	White
Middle	Alternate dots and dashes (1300 Hz)	Amber
Outer	2 dashes/sec (400 Hz)	Blue

* When the identifying tone is keyed, the respective indicating light will blink accordingly.

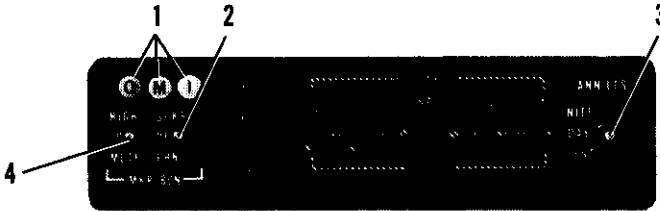

AUDIO CONTROL PANEL FOR USE WITH ONE OR TWO TRANSMITTERS

1. MARKER BEACON ANNUNCIATOR LIGHTS:

OUTER - Light illuminates blue to indicate passage of outer marker beacon.
MIDDLE - Light illuminates amber to indicate passage of middle marker beacon.
INNER and FAN - Light illuminates white to indicate passage of inner and fan marker beacon.

2. SPEAKER/OFF/PHONE SELECTOR SWITCH:

SPEAKER POSITION - Turns set on and selects speaker for aural reception.
OFF POSITION - Turns set off.
PHONE POSITION - Turns set on and selects phone for aural reception.

3. ANNUNCIATOR LIGHTS SWITCH:

NITE POSITION - Places the annunciator lights in a dim lighting mode for night flying operations. Light intensity of the NITE position is controlled by the RADIO LT dimming rheostat.
DAY POSITION - Places the annunciator lights in the full bright position for daylight flying operations.
TEST POSITION - Illuminates all marker beacon annunciator lights (and other annunciators) in the full bright position to verify operation of annunciator lights.

4. HIGH/LO/MUTE SELECTOR SWITCH:

HIGH POSITION - Receiver sensitivity is positioned for airway flying.
LO POSITION - Receiver sensitivity is positioned for ILS approaches.
MUTE POSITION - The marker beacon audio signals are temporarily blanked out (for approximately 30 seconds) and then automatically restored, over the speaker or headset in order to provide voice communications without interference of marker beacon signals.

Figure 1. Cessna 400 Marker Beacon Operating Controls and Indicator Lights Supplied with Two or Less Transmitters

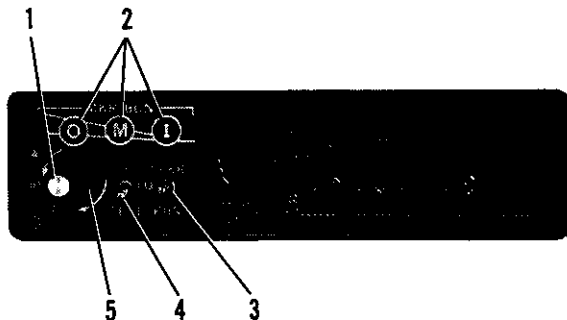

AUDIO CONTROL PANEL FOR USE WITH THREE TRANSMITTERS

1. OFF/VOLUME CONTROL:

OFF/VOL - Turns the set on or off and adjusts the audio listening level. Clockwise rotation of the smaller knob turns the set on and increases the audio level.

2. MARKER BEACON ANNUNCIATOR LIGHTS:

OUTER - Light illuminates blue to indicate passage of outer marker beacon.
MIDDLE - Light illuminates amber to indicate passage of middle marker beacon.
INNER and FAN - Light illuminates white to indicate passage of inner or fan marker beacon.

3. SPEAKER/PHONE SELECTOR SWITCH:

SPEAKER POSITION - Selects speaker for aural reception.
PHONE POSITION - Selects headphone for aural reception.

4. HI/LO/TEST SELECTOR SWITCH:

HI POSITION - Receiver sensitivity is positioned for airway flying.
LO POSITION - Receiver sensitivity is positioned for ILS approaches.
TEST POSITION - Illuminates all annunciator lights in the full bright position to verify operation of annunciator lights.

5. LIGHT DIMMING CONTROL:

BRT - Provides light dimming for the annunciator lights. Clockwise rotation of the larger knob increases light intensity.

Figure 2. Cessna 400 Marker Beacon Operating Controls and Indicator Lights Supplied With Three Transmitters.

SECTION 2 LIMITATIONS

There is no change to the airplane limitations when this avionic equipment is installed.

SECTION 3 EMERGENCY PROCEDURES

There is no change to the airplane emergency procedures when this avionic equipment is installed.

SECTION 4 NORMAL PROCEDURES

MARKER BEACON OPERATING PROCEDURES FOR USE WITH AUDIO CONTROL PANELS PROVIDED WITH ONE OR TWO TRANSMITTERS (REF. FIG. 1)

1. SPKR/OFF/PHN Selector Switch -- SELECT desired speaker or phone audio. Either selected position will turn set on.
2. NITE/DAY/TEST Selector Switch -- PRESS to TEST position and verify that all marker beacon annunciator lights illuminate full bright to indicate lights are operational.
3. NITE/DAY/TEST Selector Switch -- SELECT desired position for NITE or DAY lighting.
4. HIGH/LO/MUTE Selector Switch -- SELECT HI position for airway flying or LO position for ILS approaches.

NOTE

Press MUTE switch to provide an approximate 30 seconds temporary blanking out of Marker Beacon audio tone. The marker beacon audio tone identifier is automatically restored at the end of the muting period.

NOTE

Due to the short distance typical between the middle marker and inner marker, audio identification of the inner marker may not be possible if muting is activated over the middle marker.

MARKER BEACON OPERATING PROCEDURES FOR USE WITH AUDIO CONTROL PANELS PROVIDED WITH THREE TRANSMITTERS. (REF. FIG. 2)

1. OFF/VOL Control -- TURN to VOL position and adjust to desired listening level. Clockwise rotation increases audio level.
2. HI/LO Sen Switch -- SELECT HI position for airway flying or LO position for ILS approaches.
3. SPKR/PHN Switch -- SELECT speaker or phone audio.
4. BRT Control -- SELECT BRT (full clockwise). ADJUST as desired when illuminated over marker beacon.
5. TEST Switch -- PRESS to TEST position and verify that all marker beacon annunciator lights will illuminate full bright to indicate lights are operational.

SECTION 5

PERFORMANCE

There is no change to the airplane performance when this avionic equipment is installed. However, the installation of an externally mounted antenna or several related external antennas, will result in a minor reduction in cruise performance.

SUPPLEMENT

CESSNA 400 AUTOPILOT (Type AF-420A)

SECTION 1 GENERAL

Cessna 400 Autopilot (Type AF-420A) is a two axis automatic flight control system that governs the position of the ailerons and elevators to provide automatic roll and pitch stability as commanded by the selected mode of operation. The system also provides for tracking of any magnetic heading, automatic intercept and tracking of VOR radials and includes manual turn and pitch control, altitude hold, and NAV 1 or NAV 2 receiver selection. There is an LS coupler in the autopilot system.

The major components of the standard 400 autopilot system consist of a control unit mounted in the lower center stack of the instrument panel or lower console, a directional gyro, and an aileron elevator actuator. On some aircraft an optional slaved compass system is offered consisting of a slaved directional gyro incorporating a built-in slaving indicator that monitors heading displacement error between the flux detector and the slaved DG, a remote mounted flux detector and a slaving accessory unit.

The control unit (flight controller) contains most of the operating controls for the autopilot. In addition, controls for the directional gyro are mounted on the front of the gyro and an A/P NAV 1/NAV 2 selector switch is installed adjacent to the control unit to allow the autopilot to operate in conjunction with either navigation receiver.

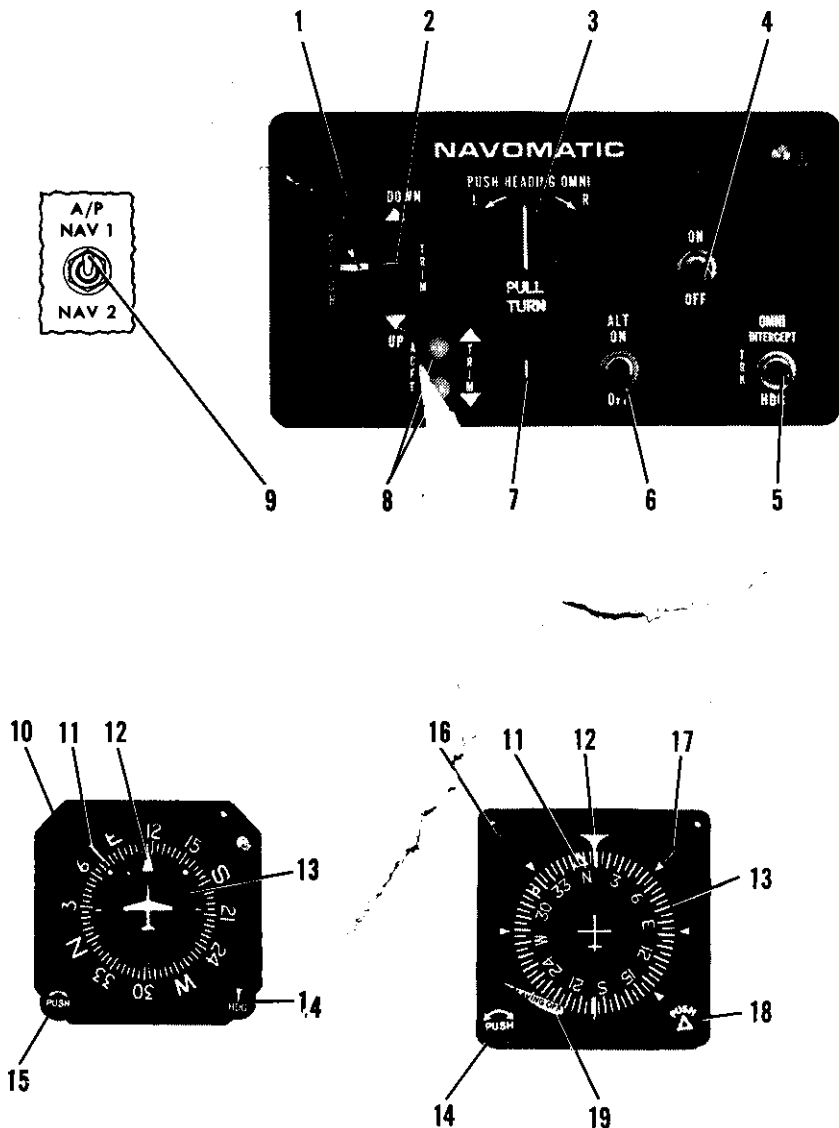

Figure 1. Cessna 400 Autopilot (Type AF-420A) (Sheet 1 of 3)

1. PITCH CONTROL - Controls pitch attitude of airplane. When rotated toward UP, airplane will pitch up. When rotated toward DWN, airplane will pitch down. Pitch attitude depends on displacement of control from DETENT (level flight) position. (Must be coordinated with aircraft elevator trim.)
2. PITCH TRIM - Used only when PITCH control is in detent to trim airplane for level flight.
3. PULL-TURN CONTROL KNOB - When pulled out and turned, airplane can be banked right (R) or left (L). When in detent and pushed in, intercepts and maintains selected heading or VOR radial.
4. ON-OFF SWITCH - Controls primary power to Navomatic 400.
5. FUNCTION SWITCH - Selects mode of operation. In HDG position heading hold circuits are engaged. In OMNI INTERCEPT position, omni coupler is engaged. In TRK position, omni coupler is engaged, but turn rate is limited to that appropriate to two dots course deviation.
6. ALT ON-OFF - When at ALT ON, with PITCH control in detent, maintains the selected altitude. Movement of the PITCH control from level flight detent disengages the altitude hold circuit.
7. LATERAL TRIM - Used when PULL-TURN control knob is pulled out and in detent to trim aircraft for wing level attitude.
8. AIRCRAFT TRIM LIGHTS - These lights illuminate as the pitch actuator corrects toward the selected attitude or when the aircraft is out of trim to a degree that the pitch actuator is not able to correct to the attitude selected by the PITCH control. When the upper light is illuminated, the aircraft elevator trim wheel should be rotated forward for more nose down trim. When the lower light is illuminated, a need for additional nose up trim is indicated.
9. AUTOPILOT (A/P) NAV 1 OR NAV 2 SELECTOR SWITCH - Selects the desired navigation receiver.
10. UNSLAVED DIRECTIONAL GYRO - When properly set to agree with the magnetic compass, the DG will provide a stable visual indication of aircraft heading to the pilot and also provides electrical heading information to the autopilot.
11. HEADING INDEX (BUG) - Displays selected heading relative to the compass card.
12. LUBBER LINE - Provides airplane heading reference index.
13. COMPASS CARD - Rotates to display heading of airplane with reference to lubber line (12) on directional gyros.

Figure 1. Cessna 400 Autopilot (Type AF-420A) (Sheet 2 of 3)

14. **HEADING SELECTOR KNOB (HDG)** - When pushed in, the heading bug (11) may be positioned to the desired magnetic heading by rotating the HDG selector knob. Also used to select VOR course.
15. **GYRO ADJUSTMENT KNOB (PUSH)** - When pushed in, allows the pilot to manually rotate the gyro compass card (13) to correspond with the magnetic heading indicated by the compass. The unslaved gyro's (10) compass card (13) must be manually reset periodically to compensate for precessional errors in the gyro. The slaved directional gyro's (16) compass card (13) will automatically realign itself due to the slaving features. However, the slaved DG may be manually reset at any time in order to accelerate precession adjustment.
16. **OPTIONAL SLAVED DIRECTIONAL GYRO** - When properly set to agree with the magnetic compass, the slaved DG will provide a magnetically stabilized visual indication of aircraft heading and also provides electrical heading information to the autopilot. The slaved DG eliminates the need to manually compensate for precessional errors in the gyro.
17. **GYRO SLAVING INDICATOR** - Displays visual indication of heading indicator and flux detector synchronization. When slaving needle is aligned with the DG 45° right index, it shows that the heading indicator agrees with the aircraft magnetic heading. Off-center pointer deflections show the direction of heading indicator error relative to aircraft magnetic heading. The gyro adjustment knob (15) may be used at any time to more rapidly accomplish synchronization of the heading indicator reading with magnetic heading as indicated by the slaving indicator.
18. **HEADING SELECTOR KNOB (PUSH/▲)** - When pushed in the heading bug (11) may be positioned to the desired magnetic heading by rotating the PUSH/▲ selector knob. Also used to select VOR course when an autopilot is installed with Nav/Com radios.
19. **SLAVING OFF WARNING FLAG** - When out of view, indicates presence of slaving voltage. When in view, indicates absent or low slaving voltage.

Figure 1. Cessna 400 Autopilot (Type AF-420A) (Sheet 3 of 3)

SECTION 2 LIMITATIONS

The following autopilot limitations must be adhered to during airplane operations:

1. ON-OFF Switch -- OFF for takeoff and landing.
2. Maximum Airspeed for Autopilot Operation -- 165 KIAS.
3. Possible Altitude Loss with Autopilot Malfunction -- 250 feet.

SECTION 3 EMERGENCY PROCEDURES

IN CASE OF AUTOPILOT MALFUNCTION:

1. Airplane Control Wheel -- OPERATE as required to manually override the autopilot.

NOTE

The servos may be manually overpowered at any time without damage. However, this practice should be kept to a minimum since slip clutch wear will result from extended periods of manual overpower.

2. Autopilot ON-OFF Switch -- OFF.

NOTE

If electrical malfunction persists, turn aircraft master or avionics power switch OFF.

SECTION 4 NORMAL PROCEDURES

BEFORE TAKEOFF AND LANDING:

1. Autopilot ON-OFF Switch -- OFF.

IN-FLIGHT WINGS LEVELING:

1. Airplane Elevator and Rudder Trim -- ADJUST.
2. Avionics Power Switch -- ON.
3. PULL-TURN Knob -- PULL out and center in detent.
4. PITCH Control -- ADJUST to centered position.
5. PITCH TRIM Lever -- ADJUST to centered position.
6. ON-OFF Switch -- ON.
7. Lateral Trim Lever -- ADJUST to level wings.
8. PITCH TRIM Lever -- ADJUST for longitudinal trim.

ALTITUDE HOLD:

1. PITCH Control -- DETENT position.
2. OFF-ALT ON Switch -- ALT ON.

COMMAND TURNS:

1. PULL-TURN Knob -- PULL and ROTATE.

CLIMB OR DESCENT:

1. Aircraft Power and Trim -- ADJUST.
2. PITCH Control Wheel -- Rotate UP or DOWN.
3. Lateral Trim Lever -- ADJUST to level wings.
4. PITCH Trim Lever -- ADJUST if aircraft trim light is illuminated.

NOTE

If trim light remains illuminated readjust the aircraft elevator trim wheel.

HEADING SELECT:

1. PUSH Knob on DG -- SET to aircraft magnetic heading.
2. HDG Knob on DG -- ROTATE "bug" to desired heading.
3. Function Switch -- SET to HDG.
4. PULL-TURN Knob -- PUSH.

NOTE

Airplane will turn automatically to selected heading.

OMNI COUPLING:

1. PULL-TURN Knob -- PULL out.
2. A/P NAV 1/NAV 2 Selector Switch (On Instrument Panel) -- SELECT desired Nav receiver.
3. Nav Indicator OBS (or ARC) Knob -- SET VOR course.
4. HDG Knob DG -- ROTATE "bug" to agree with OBS on CDI.
5. Function Switch -- SET to OMNI INTERCEPT.
6. PULL-TURN Knob -- PUSH.

NOTE

Airplane will automatically intercept at 45° and then track the selected omni course.

7. Function Switch -- SET to TRK for VOR station passage and smoother tracking of omni radials.

SECTION 5 PERFORMANCE

There is no change to the airplane performance when this avionics equipment is installed.

SUPPLEMENT

CESSNA 400 NAV/COM (720-Channel - Type RT-485A)

SECTION 1 GENERAL

The Cessna 400 Nav/Com (Type RT-485A), shown in Figure 1, consists of a panel-mounted receiver-transmitter and a single or dual-pointer remote 300 or 400 Series course deviation indicator.

The set includes a 720-channel VHF communications receiver-transmitter and a 200-channel VHF navigation receiver, both of which may be operated simultaneously. The communications receiver-transmitter receives and transmits signals between 118.000 and 135.975 MHz in 25-kHz steps. The navigation receiver receives omni and localizer signals between 108.00 and 117.95 MHz in 50 kHz steps. The circuits required to interpret the omni and localizer signals are located in the course deviation indicator. Microprocessor frequency management provides storage for 3 preset NAV and 3 preset COM frequencies in MEMORY. A "keep-alive" voltage prevents loss of the preset frequencies when the Nav/Com is turned off. Both the communications and navigation operating frequencies are digitally displayed by incandescent readouts on the front panel of the Nav/Com.

A DME receiver-transmitter or a glide slope receiver, or both, may be interconnected with the Nav/Com set for automatic selection of the associated DME or glide slope frequency. When a VOR frequency is selected on the Nav/Com, the associated VORTAC or VOR-DME station frequency will also be selected automatically; likewise, if a localizer frequency is selected, the associated glide slope frequency will be selected automatically.

The 400 Nav/Com may be installed with either 300 or 400 Series course deviation indicators. The 400 Series Nav/Com indicators incorporate Automatic Radial Centering and a Course Datum synchro as standard features. The 300 Series course deviation indicators do not incorporate Course Datum synchro but are offered with, or without, Automatic Radial Centering.

NOTE

An autopilot option utilizing Course Datum is not available on this aircraft.

Both the 300 and 400 Series course deviation indicators include either a single-pointer and related NAV flag for VOR/LOC indication only, or dual pointers and related NAV and GS flags for both VOR/LOC and glide slope indications. Both types of indicators incorporate a back-course lamp (BC) which lights when back course (reversed sense) operation is selected. Indicators with Automatic Radial Centering will, when selected, automatically indicate the bearing TO or FROM the VOR station.

The Cessna 400 Nav/Com incorporates a variable threshold automatic squelch. With this squelch system, you set the threshold level for automatic operation - the further clockwise the lower the threshold - or the more sensitive the set. When the signal is above this level, it is heard even if the noise is very close to the signal. Below this level, the squelch is fully automatic so when the background noise is very low, very weak signals (that are above the noise) are let through. For normal operation of the squelch circuit, just turn the squelch clockwise until noise is heard - then back off slightly until it is quiet, and you will have automatic squelch with the lowest practical threshold. This adjustment should be rechecked periodically during each flight to assure optimum reception.

All controls for the Nav/Com, except the omni bearing selector (OBS) knob or automatic radial centering (ARC) knob, which is located on the course deviation indicator, are mounted on the front panel of the receiver-transmitter. The audio control panels used in conjunction with this radio are shown and described in Section 7 of this handbook.

SECTION 2

LIMITATIONS

There is no change to the airplane limitations when this avionic equipment is installed.

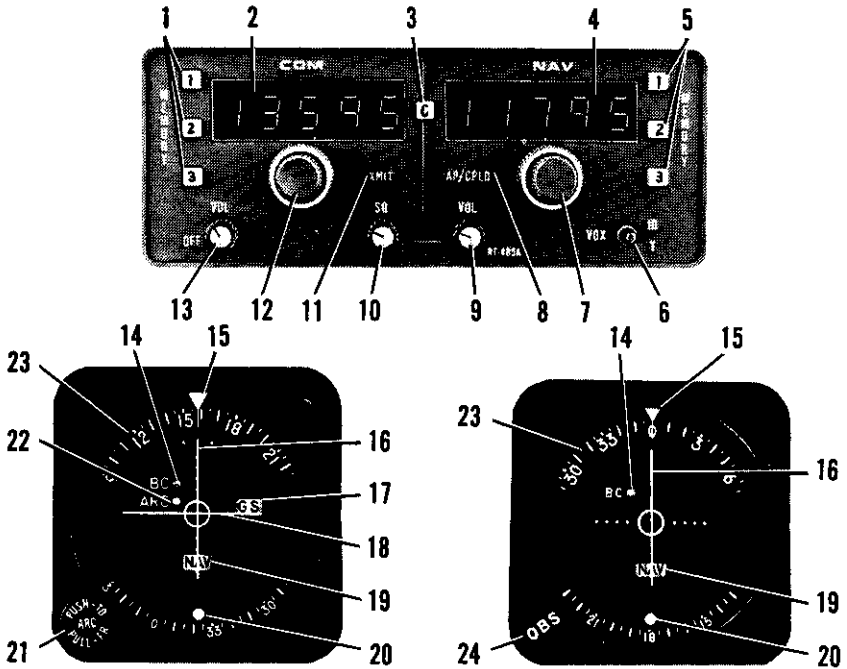

TYPICAL 300 SERIES INDICATORS

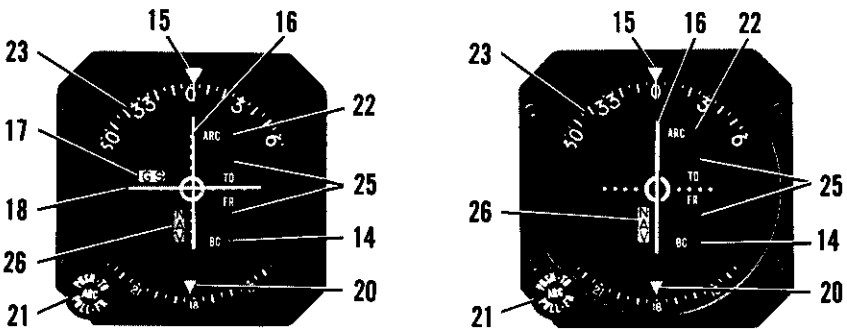

TYPICAL 400 SERIES INDICATORS

Figure 1. Cessna 400 Nav/Com (Type RT-485A), Operating Controls and Indicators (Sheet 1 of 4)

1. COM MEMORY 1, 2 & 3 PUSHBUTTONS - When a COM MEMORY pushbutton is pressed, the preset selected frequency will appear in the COM frequency window for use as the selected operating frequency. Each pushbutton will illuminate white when pressed and the light will go out on the previously selected pushbutton. Three preset frequencies may be stored in MEMORY and selected as desired, by merely pressing the appropriate COM MEMORY pushbutton to recall the desired operating frequency. If electrical power to the set's "keep-alive" circuit has not been interrupted, upon turn-on, the set will automatically recall the last COM MEMORY frequency selected by the MEMORY pushbutton. If electrical power is removed from the set's "keep-alive" circuit (such as radio removal or battery replacement) for more than 15 seconds, upon turn-on, the COM MEMORY circuits will have to be reset and COM 1 MEMORY will automatically be selected with the lowest operating frequency (118.000 MHz) selected.
2. COMMUNICATION OPERATING FREQUENCY READOUT - Indicates COM frequency in use. Third decimal place not shown.
3. CYCLE BUTTON (C) - Selects last illuminated decimal place on COM frequency in use. If last decimal place is 2 or 7, pressing C pushbutton changes number to 5 or 0, respectively. If last decimal place is 5 or 0, pressing C pushbutton changes number to 7 or 2, respectively. When the last illuminated digit on the set is 2 or 7, the third digit on the set (not shown) will always be 5. When the last illuminated digit on the set is 0 or 5, the third digit on the set (not shown) will always be 0. Also provides test function by holding C pushbutton pressed for more than 1.7 seconds. This lights each COM and NAV MEMORY pushbutton in turn, and displays the corresponding preset frequency in MEMORY.
4. NAVIGATION OPERATING FREQUENCY READOUT - Indicates NAV frequency in use.
5. NAV MEMORY 1, 2 & 3 PUSHBUTTONS - When a NAV MEMORY pushbutton is pressed, the preset selected frequency will appear in the NAV frequency window for use as the selected operating frequency. Each pushbutton will illuminate white when pressed and the light will go out on the previously selected pushbutton. Three preset frequencies may be stored in MEMORY and selected as desired, by merely pressing the appropriate NAV MEMORY pushbutton to recall the desired operating frequency. If electrical power to the set's "keep-alive" circuit has not been interrupted, upon turn-on, the set will automatically recall the last NAV MEMORY frequency selected by the MEMORY pushbutton. If electrical power is removed from the set's "keep-alive" circuit (such as radio removal or battery replacement) for more than 15 seconds, upon turn-on, the NAV MEMORY circuits will have to be reset and NAV 1 MEMORY will automatically be selected with the lowest operating frequency (108.000 MHz) selected.
6. ID-VOX-T SWITCH - In ID position, station identifier signal is audible; in VOX (Voice) position, identifier signal is suppressed; in T (Momentary On) position, the self-test function is selected, and the AP/CPLD annunciator illuminates amber and the XMIT annunciator illuminates green.
7. NAVIGATION RECEIVER FREQUENCY SELECTORS - Outer knob changes NAV frequency in 1-MHz steps between 108 and 117 MHz; inner knob changes NAV frequency in .05-MHz steps between .00 and .95 MHz; simultaneously selects paired glide slope frequency and DME channel.

Figure 1. Cessna 400 Nav/Com (Type RT-485A), Operating Controls and Indicators (Sheet 2 of 4)

8. AUTOPILOT COUPLED ANNUNCIATOR (AP/CPLD) - Illuminates amber when a 400B or 400B IFCS autopilot is coupled to NAV VOR/LOC converter output (non-operational with 200A, 300A, 400, 400A and 400A IFCS autopilots).
9. NAV VOLUME CONTROL (VOL) - Adjusts volume of navigation receiver audio.
10. SQUELCH CONTROL - Used to adjust signal threshold necessary to activate COM receiver audio. Clockwise rotation increases background noise (decreases squelch action); counterclockwise rotation decreases background noise.
11. TRANSMIT ANNUNCIATOR (XMIT) - Illuminates green when transmitter output is normal while mike is keyed.
12. COMMUNICATION RECEIVER FREQUENCY SELECTORS - Outer knob changes COM frequency in 1-MHz steps between 118 and 135 MHz; inner knob changes COM frequency in .05 MHz steps between .025 and .975 MHz or between .000 and .950 MHz depending on selection of C button.
13. COM OFF-VOLUME CONTROL (OFF-VOL) - Combination ON/OFF switch and volume control; turns on Nav/Com set and controls volume of COM receiver audio.
14. BACK-COURSE LAMP (BC) - Amber light illuminates when an autopilot's back-course function is engaged and receiver is tuned to a localizer frequency; indicates course deviation pointer is reversed. BC light dimming is only available when installed with an audio control panel incorporating the annunciator lights DAY/NITE selector switch.
15. COURSE INDEX - Indicates selected VOR COURSE.
16. COURSE DEVIATION POINTER - Indicates course deviation from selected omni course or localizer centerline.
17. GLIDE SLOPE "GS" FLAG - When visible, red GS flag indicates unreliable glide slope signal or improperly operating equipment. Flag disappears when a reliable glide slope signal is being received.
18. GLIDE SLOPE DEVIATION POINTER - Indicates deviation from ILS glide slope.
19. NAV/TO-FROM INDICATOR - Operates only with a VOR or localizer signal. Red NAV position (Flag) indicates unusable signal. With usable VOR signal, indicates whether selected VOR course is TO or FROM station. With usable localizer signal, TO flag is in view.
20. RECIPROCAL COURSE INDEX - Indicates reciprocal of selected VOR course.
21. AUTOMATIC RADIAL CENTERING (ARC) PUSH-TO/PULL-FR SELECTOR - In center detent, functions as conventional OBS. Pushed to inner (Momentary On) position, rotates OBS course card to center course deviation pointer with a TO flag, then returns to conventional OBS selection. Pulled to outer detent, continuously drives OBS course card to indicate bearing from VOR station, keeping

Figure 1. Cessna 400 Nav/Com (Type RT-485A), Operating Controls and Indicators (Sheet 3 of 4)

course deviation pointer centered, with a FROM flag. ARC function will not operate on localizer frequencies.

NOTE

Engaging either Automatic Radial Centering (ARC) functions will alter the airplane's course anytime the autopilot is engaged and coupled to any frequency other than a localizer frequency.

22. AUTOMATIC RADIAL CENTERING (ARC) LAMP - Amber light illuminates when Automatic Radial Centering is in use. ARC light dimming is only available when installed with an audio control panel incorporating the annunciator lights DAY/NITE selector switch.
23. COURSE CARD - Indicates selected VOR course under course index.
24. OMNI BEARING SELECTOR (OBS) - Rotates course card to select desired VOR radial.
25. TO/FROM INDICATOR (TO/FR) - Operates only with a usable VOR or localizer signal. When white flag is in view, indicates whether selected course is TO or FROM station. With usable localizer signal, TO flag is in view.
26. NAV INDICATOR FLAG - When in view, red NAV position (Flag) indicates the selected VOR or localizer signal is unusable.

Figure 1. Cessna 400 Nav/Com (Type RT-485A), Operating Controls and Indicators (Sheet 4 of 4)

SECTION 3

EMERGENCY PROCEDURES

There is no change to the airplane emergency procedures when this avionic equipment is installed. However, if the frequency readouts fail, the frequency controls should not be moved due to the difficulty of obtaining a known frequency under this condition. The radio will remain operational on the last frequency selected, and the preset frequencies in MEMORY may be selected by pressing the appropriate MEMORY pushbutton.

SECTION 4

NORMAL PROCEDURES

PRESETTING NAV/COM FREQUENCIES IN MEMORY:

1. COM OFF/VOL CONTROL -- TURN ON; adjust to desired audio level.
2. MEMORY 1 Pushbutton -- PRESS desired NAV or COM pushbutton 1 momentarily to alert the memory bank of a forthcoming frequency to be stored.
3. FREQUENCY SELECTORS -- MANUALLY ROTATE corresponding NAV or COM frequency selectors (press C pushbutton as required to select the desired third fractional COM digit) until the desired frequency is shown in the operating frequency readout window. The frequency displayed will be automatically transferred into MEMORY 1.

NOTE

Do not press the C pushbutton more than about 2 seconds while selecting fractional frequencies or you will activate the MEMORY test function.

4. MEMORY 2 and 3 Pushbuttons -- REPEAT STEPS 2 and 3 using next desired NAV or COM MEMORY to be stored. Up to 3 NAV and 3 COM frequencies may be stored for automatic recall frequency selection.

NOTE

The operating frequency set in the selected MEMORY position will automatically be changed in the MEMORY bank any time the operating frequency is manually changed.

COMMUNICATION RECEIVER-TRANSMITTER OPERATION:

1. COM OFF/VOL Control -- TURN ON.
2. XMTR SEL Switch (on audio control panel) -- SET to desired 400 Nav/Com.
3. SPEAKER/PHONE Selector Switches (on audio control panel) -- SET to desired mode.
4. COM Frequency Selection -- SELECT desired operating frequency by either pressing a COM MEMORY 1, 2 or 3 pushbutton to recall a preset frequency, or by manually selecting the desired operating frequency using the COM frequency selectors and C pushbutton.

5. VOL Control -- ADJUST to desired audio level.
6. SQ Control -- ROTATE counterclockwise to just eliminate background noise.
7. Mike Button:
 - a. To Transmit -- DEPRESS and SPEAK into microphone.

NOTE

Sidetone may be selected by placing the AUTO selector switch (on audio control panel) in either the SPEAKER or PHONE position, or may be eliminated by placing the AUTO selector switch in the OFF position. Adjustment of sidetone on audio control panels supplied with three transmitters cannot be accomplished externally. However, audio control panels supplied with one or two transmitters have sidetone adjustment pots that are accessible through the front of the audio control panel with a small screwdriver.

- b. XMIT Annunciator Light -- CHECK ON (green light illuminated).
- c. To Receive -- RELEASE mike button.

NAVIGATION OPERATION:

NOTE

The pilot should be aware that on many Cessna airplanes equipped with the windshield mounted glide slope antenna, pilots should avoid use of 2700 \pm 100RPM on airplanes equipped with a two-bladed propeller or 1800 \pm 100 RPM on airplanes equipped with a three-bladed propeller during ILS approaches to avoid oscillations of the glide slope deviation pointer caused by propeller interference.

1. COM OFF/VOL Control -- TURN ON; adjust to desired audio level.
2. SPEAKER/PHONE Selector Switches (on audio control panel) -- SET to desired mode.
3. NAV Frequency Selection -- SELECT desired operating frequency by either pressing a NAV MEMORY 1, 2 or 3 pushbutton to recall a preset frequency, or by using NAV frequency selectors.
4. NAV VOL Control -- ADJUST to desired audio level.
5. ID-VOX-T Switch:
 - a. To Identify Station -- SET to ID to hear navigation station identifier signal.
 - b. To Filter Out Station Identifier Signal -- SET to VOX to include filter in audio circuit.

6. ARC PUSH-TO/PULL-FROM Knob (If Applicable):
 - a. To Use As Conventional OBS -- PLACE in center detent and select desired course.
 - b. To Obtain Bearing TO VOR Station -- PUSH (ARC/PUSH-TO) knob to inner (Momentary On) position.

NOTE

ARC lamp will illuminate amber while the course card is moving to center the course deviation pointer. After alignment has been achieved to reflect bearing TO VOR, automatic radial centering will automatically shut down, causing the ARC lamp to go out and the ARC knob to return to the center detent position and function as a normal OBS.

- c. To obtain Continuous Bearing FROM VOR Station -- PULL (ARC/PULL-FR) knob to outer detent.

NOTE

ARC lamp will illuminate amber, OBS course card will turn to center the course deviation pointer with a FROM flag to indicate bearing from VOR station. This system will continually drive to present the VOR radial the aircraft is on until manually returned to the center detent by the pilot.

VOR SELF-TEST OPERATION:

1. COM OFF/VOL Control -- TURN ON.
2. NAV Frequency Selector Switches -- SELECT usable VOR station signal.
3. OBS Knob -- SET for 0° course at course index; course deviation pointer centers or deflects left or right, depending on bearing of signal; NAV/TO-FROM indicator shows TO or FROM.
4. ID/VOX/T Switch -- PRESS to T and HOLD at T; course deviation pointer centers, NAV/TO-FROM indicator shows FROM and AP/CPLD and XMIT annunciators light.
5. OBS Knob -- TURN to displace course approximately 10° to either side of 0° (while holding ID/VOX/T to T). Course deviation pointer deflects full scale in direction corresponding to course displacement. NAV/TO-FROM indicator shows FROM.
6. ID/VOX/T Switch -- RELEASE for normal operation.

NOTE

This test does not fulfill the requirements of FAR 91.25.

MEMORY TEST OPERATION:

1. C Pushbutton -- PUSH for about 2 seconds. Each COM and NAV MEMORY pushbutton (1, 2 & 3) will illuminate white, in turn, with the corresponding preset frequency displayed.

NOTE

If the "keep-alive" circuit has not been interrupted, the MEMORY test will always start with the last COM MEMORY selected and cycle through the remaining COM and NAV preset frequencies. The MEMORY test will always stop on the last selected COM and NAV preset frequencies.

SECTION 5

PERFORMANCE

There is no change to the airplane performance when this avionic equipment is installed. However, the installation of an externally mounted antenna or several related external antennas, will result in a minor reduction in cruise performance.

SUPPLEMENT

CESSNA 400 NAV/COM (Type RT-485A)

WITH

CESSNA 400 AREA **NAVIGATION SYSTEM** (Type RN-478A)

SECTION 1

GENERAL

The Cessna 400 Nav/Com (Type RT-485A) Set with Cessna 400 Area Navigation (RNAV-Type RN-478A) consists of a RT-485A Nav/Com, a R-476A DME system, a RN-478A Area Navigation Computer and a Course Deviation Indicator, with or without, the optional Automatic Radial Centering (ARC) feature. The RN-478A includes circuits which combine the VOR navigation information with distance information from the R-476A DME system to provide data for area navigation. Operating information for the communication set and for VOR/localizer navigation is presented in this supplement. Operating information for area navigation and for DME is presented in separate supplements. Microprocessor frequency management provides storage for 3 preset NAV and 3 preset COM frequencies in MEMORY. A "keep-alive" voltage prevents loss of the preset frequencies when the NAV/COM Switch, Avionics Power Switch, or Master Switch is turned OFF.

The RT-485A Receiver-Transmitter includes a 720-channel VHF communication receiver-transmitter which receives and transmits signals between 118.000 MHz and 135.975 MHz in 25-kHz steps. It also includes a 200-channel VHF navigation receiver which receives VOR and localizer signals between 108.00 MHz and 117.95 MHz in 50-kHz steps. The communication receiver-transmitter and the navigation receiver can be operated simultaneously.

The VOR or localizer signal from the No. 2 Navigation Receiver is

applied to the converter circuits in the RN-478A Area Navigation Computer. The converter processes the received navigation signal to provide omni bearing or localizer information for display by the course indicator.

CAUTION

If the RNAV set is removed from the airplane or becomes inoperative, the associated VHF navigation indicator will be inoperative.

The course indicator includes a Course Deviation Indicator (CDI), an Omni Bearing Selector (OBS) or Automatic Radial Centering (ARC) knob, and OFF (or NAV)/To-From Indicator Flags. It also includes an RNAV lamp (RN) which lights when area navigation operation is selected, and a back-course lamp (BC) which lights when back-course operation is selected. The IN-442AR is offered as the standard Course Deviation Indicator and an optional IN-1048AC Course Deviation Indicator is also offered when Automatic Radial Centering (ARC) is desired. When the optional IN-1048AC Course Deviation Indicator is installed, an Automatic Radial Centering lamp (ARC) is incorporated in the CDI to alert the pilot that the Automatic Radial Centering feature has been selected.

All operating controls and indicators for the Cessna 400 Nav/Com are included on the front panel of the RT-485A Receiver-Transmitter and the associated Course Deviation Indicator. These controls and indicators are shown and described in Figure 1. Operating controls for the RN-478A Area Navigation Computer, which are used for area navigation, and operating controls for the associated Type R-476A DME are shown in the appropriate supplements in this manual. Operating controls for the audio control panels used in conjunction with this radio are shown and described in Section 7 of this handbook.

SECTION 2 LIMITATIONS

There is no change to the airplane limitations when this avionic equipment is installed.

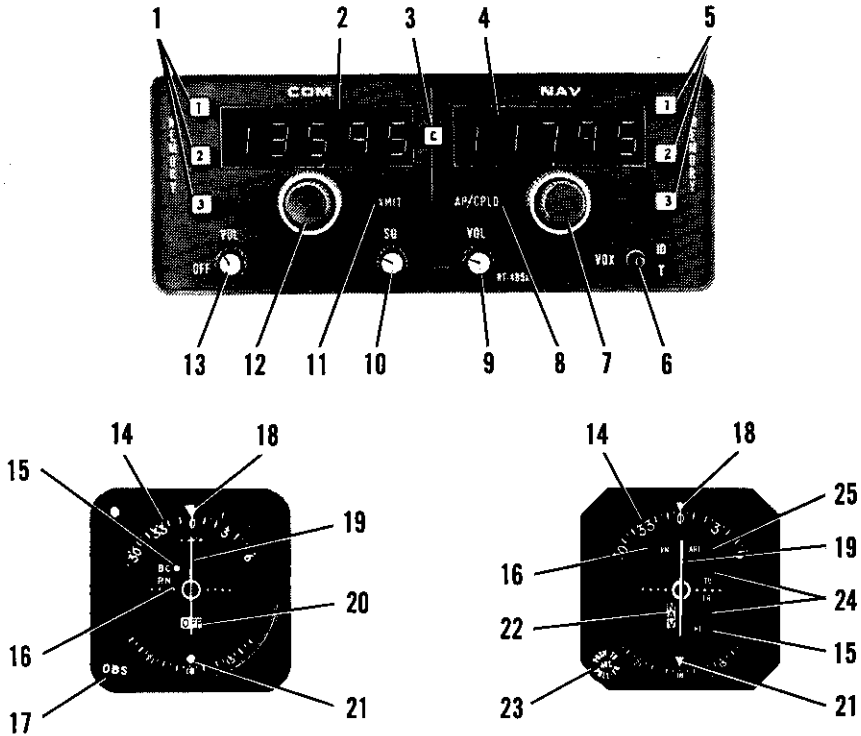

**IN-442AR STANDARD VOR/LOC CDI
WITHOUT
AUTOMATIC RADIAL CENTERING**

**IN-1048AC OPTIONAL VOR/LOC CDI
WITH
AUTOMATIC RADIAL CENTERING**

1. **COMM MEMORY 1, 2 & 3 PUSHBUTTONS** - When a COM MEMORY pushbutton is pressed, the preset selected frequency will appear in the COM frequency window for use as the selected operating frequency. Each pushbutton will illuminate white when pressed and the light will go out on the previously selected pushbutton. Three preset frequencies may be stored in MEMORY and selected as desired, by merely pressing the appropriate COM MEMORY pushbutton to recall the desired operating frequency. If electrical power to the set's "keep-alive" circuit has not been interrupted, upon turn-on, the set will automatically recall the last COM MEMORY frequency selected by the MEMORY pushbutton. If electrical power is removed from the set's "keep-alive" circuit (such as radio removal or battery replacement) for more than 15 seconds, upon turn-on, the COM MEMORY circuits will have to be reset and COM 1 MEMORY will automatically be selected with the lowest operating frequency (118.000 MHz) selected.

**Figure 1. Cessna 400 Nav/Com Set, Operating Controls and Indicators
(Sheet 1 of 4)**

2. COMMUNICATION OPERATING FREQUENCY READOUT - Indicates COM frequency in use. Third decimal place not shown.
3. CYCLE BUTTON (C) - Selects last illuminated decimal place on COM frequency in use. If last decimal place is 2 or 7, pressing C pushbutton changes number to 5 or 0, respectively. If last decimal place is 5 or 0, pressing C pushbutton changes number to 7 or 2, respectively. When the last illuminated digit on the set is 2 or 7, the third digit on the set (not shown) will always be 5. When the last illuminated digit on the set is 0 or 5, the third digit on the set (not shown) will always be 0. Also provides test function by holding C pushbutton pressed for more than 1.7 seconds. This lights each COM and NAV MEMORY pushbutton in turn, and displays the corresponding preset frequency in MEMORY.
4. NAVIGATION OPERATING FREQUENCY READOUT - Indicates NAV frequency in use.
5. NAV MEMORY 1, 2 & 3 PUSHBUTTONS - When a NAV MEMORY pushbutton is pressed, the preset selected frequency will appear in the NAV frequency window for use as the selected operating frequency. Each pushbutton will illuminate white when pressed and the light will go out on the previously selected pushbutton. Three preset frequencies may be stored in MEMORY and selected as desired, by merely pressing the appropriate NAV MEMORY pushbutton to recall the desired operating frequency. If electrical power to the set's "keep-alive" circuit has not been interrupted, upon turn-on, the set will automatically recall the last NAV MEMORY frequency selected by the MEMORY pushbutton. If electrical power is removed from the set's "keep-alive" circuit (such as radio removal or battery replacement) for more than 15 seconds, upon turn-on, the NAV MEMORY circuits will have to be reset and NAV 1 MEMORY will automatically be selected with the lowest operating frequency (108.000 MHz) selected.
6. ID-VOX-T SWITCH - In ID position, station identifier signal is audible; in VOX (Voice) position, identifier signal is suppressed; in T (Momentary On) position, the self-test function is selected, and the AP/CPLD annunciator illuminates amber and the XMIT annunciator illuminates green.
7. NAVIGATION RECEIVER FREQUENCY SELECTORS - Outer knob changes NAV frequency in 1-MHz steps between 108 and 117 MHz; inner knob changes NAV frequency in .05-MHz steps between .00 and .95 MHz; simultaneously selects paired glide slope frequency and DME channel.
8. AUTOPILOT COUPLED ANNUNCIATOR (AP/CPLD) - Non-operational with 200A, 300A and 400 autopilots.
9. NAV VOLUME CONTROL (VOL) - Adjusts volume of navigation receiver audio.
10. SQUELCH CONTROL - Used to adjust signal threshold necessary to activate COM receiver audio. Clockwise rotation increases background noise (decreases squelch action); counterclockwise rotation decreases background noise
11. TRANSMIT ANNUNCIATOR (XMIT) - Illuminates green when transmitter output is normal while mike is keyed.

Figure 1. Cessna 400 Nav/Com Set, Operating Controls and Indicators
(Sheet 2 of 4)

12. COMMUNICATION RECEIVER FREQUENCY SELECTORS - Outer knob changes COM frequency in 1-MHz steps between 118 and 135 MHz; inner knob changes COM frequency in .05 MHz steps between .025 and .975 MHz or between .000 and .950 MHz depending on setting of C button.
13. COM OFF-VOLUME CONTROL (OFF-VOL) - Combination ON/OFF switch and volume control; turns on Nav/Com set and controls volume of COM receiver audio.
14. COURSE CARD - Indicates selected VOR course under course index.
15. BACK-COURSE LAMP (BC) - Amber light illuminates when an autopilot's back-course function is engaged and receiver is tuned to a localizer frequency; indicates course deviation pointer is reversed. Light dimming is only available when installed with an audio control panel incorporating the annunciator lights DAY/NITE selector switch.
16. AREA NAV LAMP (RN) - When green light is illuminated, indicates that RNAV operation is selected. Light dimming is only available when installed with an audio control panel incorporating the annunciator lights DAY/NITE selector switch.
17. OMNI BEARING SELECTOR (OBS) - Rotates course card (12) to select desired bearing to or from a VOR station or to a selected RNAV waypoint.
18. COURSE INDEX - Indicates selected VOR or RNAV course (bearing).
19. COURSE DEVIATION POINTER - Indicates course deviation from selected VOR or RNAV course or localizer centerline.
20. OFF/TO-FROM INDICATOR - Operates only with VOR, localizer or RNAV signal. OFF position (flag) indicates unusable signal. With usable VOR signal, when OFF position disappears, indicates whether selected course is TO or FROM station or waypoint. With usable localizer signal, TO flag is in view.
21. RECIPROCAL COURSE INDEX - Indicates reciprocal of selected VOR or RNAV course.
22. NAV INDICATOR FLAG - When in view, red NAV position (Flag) indicates the selected VOR or localizer signal is unusable.
23. AUTOMATIC RADIAL CENTERING (ARC - PUSH-TO/PULL-FR) SELECTOR - In center detent, functions as conventional OBS. Pushed to inner (Momentary On) position, turns OBS course card (14) to center course deviation pointer (19) with a TO flag (24), then returns to conventional OBS selection. Pulled to outer detent, continuously drives OBS course card (14) to indicate bearing from VOR station, keeping course deviation pointer (19) centered, with a FROM flag (24). ARC function will not operate on localizer frequencies.

Figure 1. Cessna 400 Nav/Com Set, Operating Controls and Indicators
(Sheet 3 of 4)

NOTE

Engaging either Automatic Radial Centering (ARC) functions will alter the airplane's course anytime the autopilot is engaged and coupled to any frequency other than a localizer frequency.

24. INDICATOR (TO/FR) - Operates only with a usable VOR, localizer or RNAV signal. When white flag is in view, indicates whether selected course is TO or FROM station. With usable localizer signal, TO flag is in view.
25. AUTOMATIC RADIAL CENTERING (ARC) LAMP - Amber light illuminates when Automatic Radial Centering is in use. Light dimming is only available when installed with an audio control panel incorporating the annunciator lights DAY/NITE selector switch.

Figure 1. Cessna 400 Nav/Com Set, Operating Controls and Indicators
(Sheet 4 of 4)

SECTION 3 EMERGENCY PROCEDURES

There is no change to the airplane emergency procedures when this avionic equipment is installed. However, if the frequency readouts fail, the frequency controls should not be moved due to the difficulty of obtaining a known frequency under this condition. The radio will remain operational on the last frequency selected, and the preset frequencies in MEMORY may be selected by pressing the appropriate MEMORY pushbutton.

SECTION 4 NORMAL PROCEDURES

PRESETTING NAV/COM FREQUENCIES IN MEMORY:

1. COM OFF/VOL CONTROL -- TURN ON; adjust to desired audio level.
2. MEMORY 1 Pushbutton -- PRESS desired NAV or COM pushbutton 1 momentarily to alert the memory bank of a forthcoming frequency to be stored.
3. FREQUENCY SELECTORS -- MANUALLY ROTATE corresponding NAV or COM frequency selectors (press C pushbutton as required to select the desired third fractional COM digit) until the desired frequency is shown in the operating frequency readout window. The frequency displayed will be automatically transferred into MEMORY 1.

NOTE

Do not press the C pushbutton more than about 2 seconds while selecting fractional frequencies or you will activate the MEMORY test function.

4. MEMORY 2 and 3 Pushbutton -- REPEAT STEPS 2 and 3 using next desired NAV or COM MEMORY to be stored. Up to 3 NAV and 3 COM frequencies may be stored for automatic recall frequency selection.

NOTE

The operating frequency set in the selected MEMORY position will automatically be changed in the memory bank anytime the operating frequency is manually changed.

COMMUNICATIONS OPERATION:

1. COM OFF/VOL Control -- TURN ON.
2. XMTR SEL Switch (on audio control panel) -- SET to No. 2 400 Nav/Com.
3. SPEAKER/PHONE Selector Switches (on audio control panel) -- SET to desired mode.
4. COM Frequency Selection -- SELECT desired operating frequency by either pressing a COM MEMORY 1, 2 or 3 pushbutton to recall a preset frequency, or by manually selecting the desired operating frequency using the COM frequency selectors and C pushbutton.
5. VOL Control -- ADJUST to desired audio level.
6. SQ Control -- ROTATE counterclockwise to just eliminate background noise.
7. Mike Button:
 - a. To Transmit -- DEPRESS and SPEAK into microphone.

NOTE

Sidetone may be selected by placing the AUTO selector switch (on audio control panel) in either the SPEAKER or PHONE position, or may be eliminated by placing the AUTO selector switch in the OFF position. Adjustment of sidetone on audio control panels supplied with three transmitters cannot be accomplished externally. However, audio control panels supplied with two or less transmitters have sidetone adjustment pots that are accessible through the front of the audio control panel with a small screwdriver.

- b. XMIT Annunciator Light -- CHECK ON (green light illuminated).
- c. To Receive -- RELEASE mike button.

NAVIGATION OPERATION:

NOTE

The pilot should be aware that on many Cessna airplanes equipped with the windshield mounted glide slope antenna, pilots should avoid use of 2700 \pm 100 RPM on airplanes equipped with a two-bladed propeller or 1800 \pm 100 RPM on airplanes equipped with a three-bladed propeller during ILS approaches to avoid oscillations of the glide slope pointer caused by propeller interference.

1. COM OFF/VOL Control -- TURN ON; adjust to desired audio level.
2. SPEAKER/PHONE Selector Switches (on audio control panel) -- SET to desired mode.

3. NAV Frequency Selection -- SELECT desired operating frequency by either pressing a NAV MEMORY 1, 2 or 3 pushbutton to recall a preset frequency, or by using NAV frequency selectors.
4. NAV VOL Control -- ADJUST to desired audio level.
5. ID-VOX-T Switch:
 - a. To Identify Station -- SET to ID to hear navigation station identifier signal.
 - b. To Filter Out Station Identifier Signal -- SET to VOX to include filter in audio circuit.
6. ARC PUSH-TO/PULL-FROM Knob (If Applicable):
 - a. To Use As Conventional OBS -- PLACE in center detent and select desired course.
 - b. To Obtain Bearing TO VOR Station -- PUSH knob to inner (Momentary On) position.

NOTE

ARC lamp will illuminate amber while the course card is moving to center the course deviation pointer. After alignment has been achieved to reflect bearing TO VOR, automatic radial centering will automatically shut down, causing the ARC lamp to go out and the ARC knob to return to center detent position and function as a normal OBS.

- c. To obtain Continuous Bearing FROM VOR Station -- PULL (ARC/PULL-FR) knob to outer detent.

NOTE

ARC lamp will illuminate amber, OBS course card will turn to center the course deviation pointer with a FROM flag to indicate bearing from VOR station. This system will continually drive to present the VOR radial the aircraft is on until manually returned to the center detent by the pilot.

VOR SELF-TEST OPERATION:

1. COM OFF/VOL Control -- TURN ON.
2. NAV Frequency Selector Switches -- SELECT usable VOR station signal.
3. OBS Knob -- SET for 0° course at course index; course deviation pointer centers or deflects left or right, depending on bearing of signal; NAV/TO-FROM indicator shows TO or FROM.

4. ID/VOX/T Switch -- PRESS to T and HOLD at T; course deviation pointer centers, NAV/TO-FROM indicator shows FROM and AP/CPLD and XMIT annunciators light.
5. OBS Knob -- TURN to displace course approximately 10° to either side of 0° (while holding ID/VOX/T to T). Course deviation pointer deflects full scale in direction corresponding to course displacement. NAV/TO-FROM indicator shows FROM.
6. ID/VOX/T Switch -- RELEASE for normal operation.

NOTE

This test does not fulfill the requirements of FAR 91.25.

MEMORY TEST OPERATION:

1. C Pushbutton -- PUSH for about 2 seconds. Each COM and NAV MEMORY pushbutton (1, 2 & 3) will illuminate white, in turn, with the corresponding preset frequency displayed.

NOTE

If the "keep-alive" circuit has not been interrupted, the MEMORY test will always start with the last COM MEMORY selected and cycle through the remaining COM and NAV preset frequencies. The MEMORY test will always stop on the last selected COM and NAV preset frequencies.

SECTION 5 PERFORMANCE

There is no change to the airplane performance when this avionic equipment is installed. However, the installation of an externally mounted antenna or several related external antennas, will result in a minor reduction in cruise performance.

SUPPLEMENT

CESSNA 400 TRANSPONDER (Type RT-459A)

AND

OPTIONAL ALTITUDE ENCODER (BLIND)

SECTION 1

GENERAL

The Cessna 400 Transponder (Type RT-459A), shown in Figure 1, is the airborne component of an Air Traffic Control Radar Beacon System (ATCRBS). The transponder enables the ATC ground controller to "see" and identify the aircraft, while in flight, on the control center's radarscope more readily.

The Cessna 400 Transponder system consists of a panel-mounted unit, an externally-mounted antenna and an optional control wheel-mounted XPDR IDENT switch. The transponder receives interrogating pulse signals on 1030 MHz and transmits pulse-train reply signals on 1090 MHz. The transponder is capable of replying to Mode A (aircraft identification) and also to Mode C (altitude reporting) when coupled to an optional altitude encoder system. The transponder is capable of replying on both modes of interrogation on a selective reply basis on any of 4096 information code selections. The optional altitude encoder system (not part of a standard 400 Transponder system) required for Mode C (altitude reporting) operation consists of a completely independent remote-mounted digitizer that is connected to the static system and supplies encoded altitude information to the transponder. When the altitude encoder system is coupled to the 300 Transponder system, altitude reporting capabilities are available in 100-foot increments between -1000 and the airplane's maximum service ceiling.

All Cessna 400 Transponder operating controls, with the exception of the optional XPDR IDENT switch, are located on the front panel of the unit. The remote XPDR IDENT switch is located on the right hand grip of the pilot's control wheel. Functions of the operating controls are described in Figure 1.

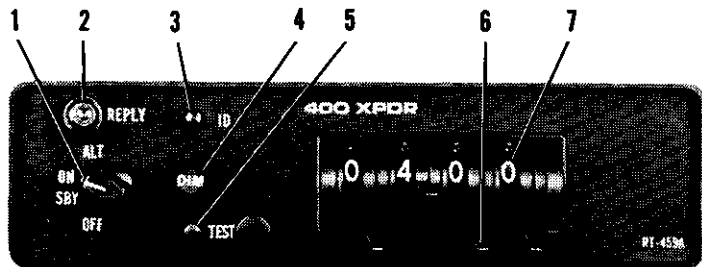

1. **FUNCTION SWITCH** - Controls application of power and selects transponder operating mode as follows:

OFF - Turns set off.

SBY - Turns set on for equipment warm-up or standby power.

ON - Turns set on and enables transponder to transmit Mode A (aircraft identification) reply pulses.

ALT - Turns set on and enables transponder to transmit either Mode A (aircraft identification) reply pulses or Mode C (altitude reporting) pulses selected automatically by the interrogating signal.

Figure 1. Cessna 400 Transponder and Altitude Encoder (Blind)
(Sheet 1 of 2)

2. **REPLY LAMP** - Lamp flashes to indicate transmission of reply pulses; glows steadily to indicate transmission of IDENT pulse or satisfactory self-test operation. (Reply lamp will also glow steadily during initial warm-up period.)
3. **IDENT (ID) SWITCH** - When depressed, selects special pulse identifier to be transmitted with transponder reply to effect immediate identification of aircraft on ground controller's display. (Reply lamp will glow steadily during duration of IDENT pulse transmission.)
4. **DIMMER (DIM) CONTROL** - Allows pilot to control brilliance of reply lamp.
5. **SELF-TEST (TEST) SWITCH** - When depressed, causes transponder to generate a self-interrogating signal to provide a check of transponder operation. (Reply lamp will glow steadily to verify self-test operation.)
6. **REPLY-CODE SELECTOR SWITCHES (4)** - Select assigned Mode A reply code.
7. **REPLY-CODE INDICATORS (4)** - Display selected Mode A reply code.
8. **REMOTE-MOUNTED DIGITIZER** - Provides an altitude reporting code range of -1000 feet up to the airplane's maximum service ceiling.
9. **REMOTE ID SWITCH (XPDR IDENT)** - Same as panel-mounted ID switch described in Item 3.

Figure 1. Cessna 400 Transponder and Altitude Encoder (Blind)
(Sheet 2 of 2)

SECTION 2

LIMITATIONS

There is no change to the airplane limitations when this avionic equipment is installed. However, the following information must be displayed in the form of a placard located near the altimeter.

ALTITUDE ENCODER EQUIPPED

SECTION 3

EMERGENCY PROCEDURES

TO TRANSMIT AN EMERGENCY SIGNAL:

1. Function Switch -- ON.
2. Reply-Code Selector Switches -- SELECT 7700 operating code.

TO TRANSMIT A SIGNAL REPRESENTING LOSS OF ALL COMMUNICATIONS (WHEN IN A CONTROLLED ENVIRONMENT):

1. Function Switch -- ON.
2. Reply-Code Selector Switches -- SELECT 7700 operating code for 1 minute; then SELECT 7600 operating code for 15 minutes and then REPEAT this procedure at same intervals for remainder of flight.

SECTION 4

NORMAL PROCEDURES

BEFORE TAKEOFF:

1. Function Switch -- SBY.

TO TRANSMIT MODE A (AIRCRAFT IDENTIFICATION) CODES IN FLIGHT:

1. Reply-Code Selector Switches -- SELECT assigned code.
2. Function Switch -- ON.

3. DIM Control -- ADJUST light brilliance of reply lamp.

NOTE

During normal operation with function switch in ON position, reply lamp flashes indicating transponder replies to interrogations.

4. ID or XPDR IDENT Button -- DEPRESS momentarily when instructed by ground controller to "squawk IDENT" (reply lamp will glow steadily, indicating IDENT operation).

TO TRANSMIT MODE C (ALTITUDE REPORTING) CODES IN FLIGHT:

1. Reply-Code Selector Switches -- SELECT assigned code.
2. Function Switch -- ALT.

NOTE

When directed by ground controller to "stop altitude squawk", turn Function Switch to ON for Mode A operation only.

NOTE

Pressure altitude is transmitted by the transponder for altitude squawk and conversion to indicated altitude is done in ATC computers. Altitude squawked will only agree with indicated altitude when the local altimeter setting in use by the ground controller is set in the aircraft altimeter.

3. DIM Control -- ADJUST light brilliance of reply lamp.

TO SELF-TEST TRANSPONDER OPERATION:

1. Function Switch -- SBY and wait 30 seconds for equipment to warm-up.
2. Function Switch -- ON.
3. TEST Button -- DEPRESS (reply lamp should light brightly regardless of DIM control setting).
4. TEST Button -- RELEASE for normal operation.

SECTION 5 PERFORMANCE

There is no change to the airplane performance when this avionic equipment is installed. However, the installation of an externally mounted antenna or several related external antennas, will result in a minor reduction in cruise performance.

SUPPLEMENT

CESSNA 400 TRANSPONDER (Type RT-459A)

AND

OPTIONAL ENCODING ALTIMETER (Type EA-401A)

SECTION 1

GENERAL

The Cessna 400 Transponder (Type RT-459A), shown in Figure 1, is the airborne component of an Air Traffic Control Radar Beacon System (ATCRBS). The transponder enables the ATC ground controller to "see" and identify the aircraft, while in flight, on the control center's radarscope more readily.

The Cessna 400 Transponder system consists of a panel-mounted unit, an externally-mounted antenna and an optional control wheel-mounted XPDR IDENT switch. The transponder receives interrogating pulse signals on 1030 MHz and transmits coded pulse-train reply signals on 1090 MHz. It is capable of replying to Mode A (aircraft identification) and also to Mode C (altitude reporting) interrogations on a selective reply basis on any of 4096 information code selections. When an optional panel mounted EA-401A Encoding Altimeter (not part of 400 Transponder System) is included in the avionic configuration, the transponder can provide altitude reporting in 100-foot increments between -1000 and +35,000 feet.

All Cessna 400 Transponder operating controls, with the exception of the optional altitude encoder's altimeter setting knob and the optional remote XPDR IDENT switch, are located on the front panel of the unit. The altimeter setting knob is located on the encoding altimeter and the remote XPDR IDENT switch is located on the right hand grip of the pilot's control wheel. Functions of the operating controls are described in Figure 1.

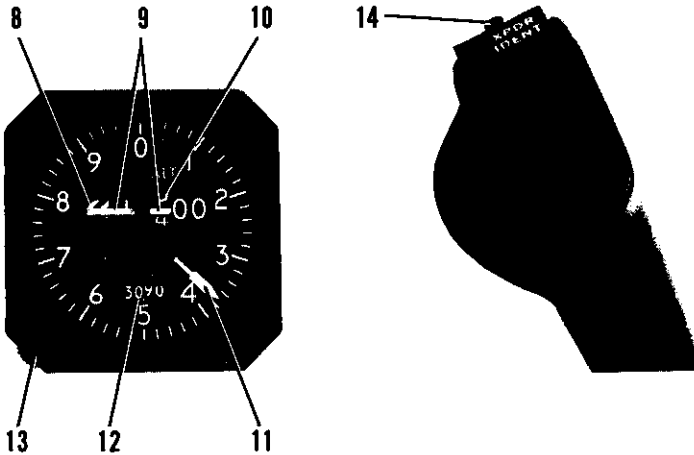
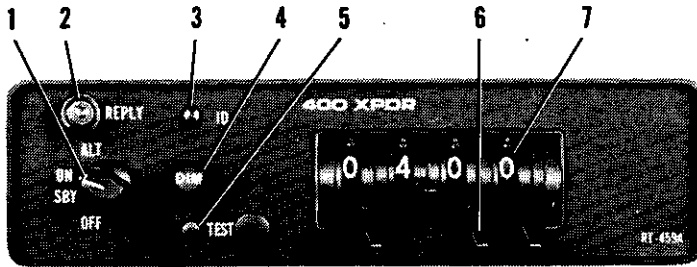

1. **FUNCTION SWITCH** - Controls application of power and selects transponder operating mode as follows:

OFF - Turns set off.

SBY - Turns set on for equipment warm-up or stand-by power.

ON - Turns set on and enables transponder to transmit Mode A (aircraft identification) reply pulses.

ALT - Turns set on and enables transponder to transmit either Mode A (aircraft identification) reply pulses or Mode C (altitude reporting) pulses selected automatically by the interrogating signal.

Figure 1. Cessna 400 Transponder and Encoding Altimeter
Operating Controls (Sheet 1 of 2)

2. **REPLY LAMP** - Lamp flashes to indicate transmission of reply pulses; glows steadily to indicate transmission of IDENT pulse or satisfactory self-test operation. (Reply lamp will also glow steadily during initial warm-up period.)
3. **IDENT (ID) SWITCH** - When depressed, selects special pulse identifier to be transmitted with transponder reply to effect immediate identification of aircraft on ground controller's display. (Reply lamp will glow steadily during duration of IDENT pulse transmission.)
4. **DIMMER (DIM) CONTROL** - Allows pilot to control brilliance of reply lamp.
5. **SELF-TEST (TEST) SWITCH** - When depressed, causes transponder to generate a self-interrogating signal to provide a check of transponder operation. (Reply lamp will glow steadily to verify self-test operation.)
6. **REPLY-CODE SELECTOR SWITCHES (4)** - Select assigned Mode A reply code.
7. **REPLY-CODE INDICATORS (4)** - Display selected Mode A reply code.
8. **1000-FOOT DRUM TYPE INDICATOR** - Provides digital altitude readout in 1000-foot increments between -1000 feet and +35,000 feet. When altitude is below 10,000 feet, a diagonally striped flag appears in the 10,000-foot window.
9. **OFF INDICATOR WARNING FLAG** - Flag appears across altitude readout when power is removed from the altimeter to indicate that readout is not reliable.
10. **100-FOOT DRUM TYPE INDICATOR** - Provides digital altitude readout in 100-foot increments between 0 and 1000 feet.
11. **20-FOOT INDICATOR NEEDLE** - Indicates altitude in 20-foot increments between 0 feet and 1000 feet.
12. **ALTIMETER SETTING SCALE - DRUM TYPE** - Indicates selected altimeter setting in the range of 27.9 to 31.0 inches of mercury on the standard altimeter or 950 to 1050 millibars on the optional altimeter.
13. **ALTIMETER SETTING KNOB** - Dials in desired altimeter setting in the range of 27.9 to 31.0 inches of mercury on the standard altimeter or 950 to 1050 millibars on the optional altimeter.
14. **REMOTE ID SWITCH (XPDR IDENT)** - Same as panel-mounted ID switch described in Item 3.

Figure 1. Cessna 400 Transponder and Encoding Altimeter
Operating Controls (Sheet 2 of 2)

SECTION 2

LIMITATIONS

There is no change to the airplane limitations when this avionic equipment is installed. However, the encoding altimeter used in this installation does have a limitation that requires a standard barometric altimeter be installed as a back-up altimeter.

SECTION 3

EMERGENCY PROCEDURES

TO TRANSMIT AN EMERGENCY SIGNAL:

1. Function Switch -- ON.
2. Reply-Code Selector Switches -- SELECT 7700 operating code.

TO TRANSMIT A SIGNAL REPRESENTING LOSS OF ALL COMMUNICATIONS (WHEN IN A CONTROLLED ENVIRONMENT):

1. Function Switch -- ON.
2. Reply-Code Selector Switches -- SELECT 7700 operating code for 1 minute; then SELECT 7600 operating code for 15 minutes and then REPEAT this procedure at same intervals for remainder of flight.

SECTION 4

NORMAL PROCEDURES

BEFORE TAKEOFF:

1. Function Switch -- SBY.

TO TRANSMIT MODE A (AIRCRAFT IDENTIFICATION) CODES IN FLIGHT:

1. Reply-Code Selector Switches -- SELECT assigned code.

2. Function Switch -- ON.
3. DIM Control -- ADJUST light brilliance of reply lamp.

NOTE

During normal operation with function switch in ON position, REPLY lamp flashes indicating transponder replies to interrogations.

4. ID or XPDR IDENT Button -- DEPRESS momentarily when instructed by ground controller to "squawk IDENT" (REPLY lamp will glow steadily, indicating IDENT operation).

TO TRANSMIT MODE C (ALTITUDE REPORTING) CODES IN FLIGHT:

1. Off Indicator Warning Flag -- VERIFY that flag is out of view on encoding altimeter.
2. Altitude Encoder Altimeter Setting Knob -- SET IN assigned local altimeter setting.
3. Reply-Code Selector Switches -- SELECT assigned code.
4. Function Switch -- ALT.

NOTE

When directed by ground controller to "stop altitude squawk", turn Function Switch to ON for Mode A operation only.

NOTE

Pressure altitude is transmitted by the transponder for altitude squawk and conversion to indicated altitude is done in ATC computers. Altitude squawked will only agree with indicated altitude when the local altimeter setting in use by the ground controller is set in the encoding altimeter.

5. DIM Control -- ADJUST light brilliance of reply lamp.

TO SELF-TEST TRANSPONDER OPERATION:

1. Function Switch -- SBY and wait 30 seconds for equipment to warm-up.
2. Function Switch -- ON or ALT.

3. TEST Button -- DEPRESS and HOLD (reply lamp should light with full brilliance regardless of DIM control setting).
4. TEST Button -- RELEASE for normal operation.

SECTION 5

PERFORMANCE

There is no change to the airplane performance when this avionic equipment is installed. However, the installation of an externally mounted antenna or several related external antennas, will result in a minor reduction in cruise performance.



Australian Government

Civil Aviation Safety Authority

CERTIFICATE OF REGISTRATION

1. Nationality and Registration Mark VH-ASJ	2. Manufacturer and Manufacturer's Designation of Aircraft CESSNA AIRCRAFT COMPANY U206G	3. Aircraft Serial Number U20605867
---	--	---

4. Name NUMBURINDI AIR PTY LTD

5. Address Numbulwar Nemburindi Community Council Gilchrist Street KATHERINE NT 0850

6. It is hereby certified that the above described aircraft has been duly entered in the Australian Civil Aircraft Register in accordance with the Convention on International Civil Aviation dated 7th December 1944 and the Commonwealth of Australia Civil Aviation Regulations. <div style="display: flex; justify-content: space-between;"> <div data-bbox="56 845 425 989"> <p>25 May 1989 Date First Registered in Australia</p> <p>09 May 2006 Date of issue of this certificate</p> </div> <div data-bbox="560 845 1008 989"> <p>11 Apr 2006 Registration holder commencement date</p> <p>Expiry date of this certificate</p> </div> </div>

For Civil Aviation Safety Authority, Ricardo Inacio Registrar, Australian Civil Aircraft Register <div style="text-align: right; margin-top: 20px;">  </div>

Note: <ul style="list-style-type: none"> This certificate is not conclusive evidence of the existence of a legal or beneficial property interest in the aircraft. This certificate must be carried on board of the aircraft when it is engaged in international air navigation. The registration holder must notify the Australian Civil Aircraft Register in writing about changes to the particulars recorded on this certificate within 14 days of the change occurring.

All certificates of registration previously issued in respect of this aircraft are hereby superseded and cancelled.

If found, this certificate should be forwarded to: Postage Paid, Civil Aviation Safety Authority, Australian Civil Aircraft Register, GPO Box 2005, Canberra ACT 2601, Australia

**This original certificate of registration
should be physically kept in the aircraft at
all times. It should be returned to the Civil
Aircraft Register within 14 days of
becoming superseded.**



Australian Government

Civil Aviation Safety Authority

CERTIFICATE OF APPOINTMENT OF REGISTERED OPERATOR

1. Nationality and Registration Mark VH-ASJ	2. Manufacturer and Manufacturer's Designation of Aircraft CESSNA AIRCRAFT COMPANY U206G	3. Aircraft Serial Number U20605867
---	--	---

The Authority confirms the appointment of
ARNHEM LAND COMMUNITY AIRLINES PTY LTD
 Gove Airport
 NHULUNBUY NT 0880

as the registered operator under regulation 47.100 for the aircraft identified above, effective from 11 Apr 2006.

This appointment is effective until the aircraft registration holder cancels either the aircraft registration or the appointment of the registered operator, or the registration holder changes.

The current registration holder for this aircraft is:
NUMBURINDI AIR PTY LTD
 Numbulwar Nemburindi Community Council
 Gilchrist Street
 KATHERINE NT 0850

For Civil Aviation Safety Authority,

Date of issue of this notice:
 09 May 2006

Ricardo Inacio
 Registrar, Australian Civil Aircraft Register

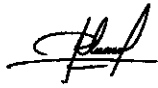

Note:

- This confirmation does not confer legal title in the aircraft to the registered operator
- The registration holder must notify the Australian Civil Aircraft Register through the approved form about changes to the registered operator
- The registration holder must notify the Australian Civil Aircraft Register in writing if the address of the registered operator changes
- A copy of this notice shall be attached to the aircraft certificate of registration

If found, this certificate should be forwarded to: Postage Paid, Civil Aviation Safety Authority, Australian Civil Aircraft Register, GPO Box 2005, Canberra ACT 2601, Australia



CERTIFICATE OF AIRWORTHINESS - AIRCRAFT

No. CS 23

Nationality and Registration Marks H - ASJ	2. Manufacturer CESSNA AIRCRAFT COMPANY Manufacturer's Designation of Aircraft U206G	3. Aircraft Serial No. U20605867 Place and Year of Construction USA 1980
--	---	--

Categories
NORMAL

5. This Certificate of Airworthiness is issued pursuant to the Convention on International Civil Aviation dated 7th December, 1944, and the Civil Aviation Regulations of Australia, in respect of the above mentioned aircraft which is considered to be airworthy when maintained and operated in accordance with the Civil Aviation Regulations and the limitations specified in the flight manual approved or issued for the aircraft under the Civil Aviation Regulations

6. Subject to suspension or cancellation under the Civil Aviation Regulations, the period during which this certificate shall remain in force shall be from its date of issue until _____
or until the aircraft ceases to be registered in the Register of Australian Aircraft.

Date of Issue **25 MAY 1989**

Signature *D. Lynn* Printed Name **D. LYNN**

Appointment (please tick appropriate box)

Delegate of the Civil Aviation Authority

Authorised Person appointed under the Civil Aviation Regulations

No entries or endorsements may be made on this certificate except in the manner and by a person authorised by the Civil Aviation Authority.

**ALL CERTIFICATES OF AIRWORTHINESS PREVIOUSLY ISSUED
IN RESPECT OF THIS AIRCRAFT ARE HEREBY SUPERSEDED
AND CANCELLED.**



Flying for Life

FLIGHT MANUAL SUPPLEMENT

REG: VH - ASJ



TYPE: Cessna U206G

S/#: U20605867

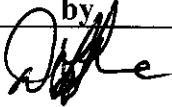
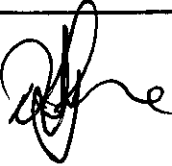

FLIGHT MANUAL SUPPLEMENT
AMENDMENT RECORD

A/C REG: VH-ASJ A/C S/#: U20605867

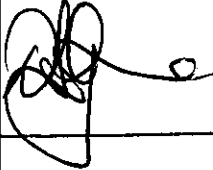
Incorporation Date	Description of Amendment	Incorporated by
10/7/02	OPERATION WITH CARLO DOOR REMOVED	
18/9/03	MAF SUPPLEMENT 0623-039 FOR CODAN 9323 HF SSB TRANSCEIVER	
2/4/04	MAF SUPPLEMENT 0621-002 F03 OPERATIONS WITH CABIN HEATING SYSTEM REMOVED	
28/2/06	MAF SUPPLEMENT 0625-014 F06 CARLO RESTRAINT SYSTEM	



SUPPLEMENTAL FLIGHT
INFORMATION
AMENDMENT RECORD

A/C REG: VH-ASJ

A/C S/#: U20605867

Incorporation Date	Description of Amendment	Incorporated by
3 MAR 06	Certificate of Airworthness # CS 23	J Shee
3 MAR 06	Certificate of Registration 25 MAY 1989	J Shee
3 MAR 06	Performance Sect 4 P-charts 7 Feb 1979	J Shee
3 MAR 06	Section 6 - Loading data 6.2 Aircraft weight 3 MAR 2006 6.3 Loading System 29 JULY 2002 Loading & Trim Sheet 28 FEB 2006	J Shee
3 MAR 06	Section 7 - Radio System 2.1 Day VFR / NIGHT VFR 25 OCT 2002	J Shee
3 MAR 06	MAF C206/210 M.E.L issued Dec 2003 AH1	J Shee
31-MAR-09	MAF CARGO Restraints	ad
9-MAR-09	LOADING DATA	J Shee
3-APR-09	KANWAD 406 EIT	J Shee
10-AUG-2011	AFM SUPPLEMENT 0628-004 FOS INSTRUMENT MARKING IN LITRES	Tim Young T Young

FLIGHT MANUAL SUPPLEMENT

8.2 - OPERATION WITH CARGO DOORS REMOVED

This supplement shall apply when the aeroplane is operated with the cargo doors removed. Only that information which differs from the basic Flight Manual is contained herein. Flight operations with the cargo doors removed are not approved unless a depressor plate is installed over the wing flap interrupt switch and a spoiler is installed on the forward edge of the cargo door opening.

LIMITATIONS

1. Do not exceed 130 knots I.A.S.
2. Operations are limited to V.F.R. only and shall be confined to normal flying manoeuvres. Turns in which the angle of bank exceeds 30 degrees, stalls, sideslips and acrobatic manoeuvres shall not be performed.
3. Smoking is not permitted.
4. When determining the gross weight for takeoff as limited by local conditions, the distance applied to the takeoff weight chart shall be the actual distance available reduced by 5 percent. When a climb weight limitation is included on the takeoff and/or landing weight charts, then the gross weights determined in accordance with this limitation shall be reduced by 5 percent.
5. No baggage or other loose articles may be carried unless adequately restrained or stowed.
6. The following placard shall be displayed on the instrument panel in full view of the pilot during actual operation with the cargo doors removed -

"OPERATION WITH CARGO DOORS REMOVED

- (i) Operations are limited to normal flying manoeuvres. Turns exceeding 30° bank, stalls, sideslips and acrobatic manoeuvres are not permitted.
 - (ii) Speeds not in excess of 130 knots I.A.S.
 - (iii) No smoking permitted.
 - (iv) No loose articles permitted.
 - (v) For additional requirements see Approved Flight Manual Supplement."
7. For requirements relating to the carriage and restraint of persons and the dropping of articles, refer to the relevant sections of Air Navigation Orders Parts 20 and 29.

**Cessna 206
AIRCRAFT FLIGHT MANUAL
SUPPLEMENT**

Codan 9323 HF SSB Transceiver.

This supplement is required to be inserted into the Aircraft Flight Manual when the aircraft is equipped with the MAF Aviation Services U206 Codan 9323 HF SSB Transceiver in accordance with MAF Aviation Services Engineering Order 0623-039 E1'

The information contained herein supplements the information in the Aircraft Flight Manual. For limitations, procedures and performance data not contained in this supplement consult the Aircraft Flight Manual.

List of Effective Pages

Revision Number	Date	Page Number *
1	18th Nov 2002	1-8

* This Aircraft Flight Manual Supplement is an eight (8) page document. Any ammendment to this document will necessitate the revision of the whole document. At each revision amended paragraphs will be indentified with a line down the right hand margin

APPROVED: *Authorised Person* per CAR (1988) 35.



Section 1 GENERAL SYSTEM DESCRIPTION

The Codan 9323 HF SSB transceiver installed in this aircraft consists of four basic units:-

- | | |
|----------------------|---------------------------|
| ① 9323 Transceiver | ② 9103 Antenna Coupler |
| ③ 9330 Control Panel | ④ Microphone with keypad. |

The 9330 control panel is mounted on the aircraft instrument panel, or radio stack, within view and reach of the pilot.

The 9323 HF transceiver and 9103 Antenna coupler are remotely mounted in some other part of the aircraft (on single engined aircraft this is usually in the rear section of the fuselage, aft of the cabin).

The keypad microphone is only needed for special purpose calls, such as selective calling (Selcall) and telephone calls. It is not needed for normal communication with Flight Service stations.

Section 2 LIMITATIONS

The Codan 9323 HF Transceiver is limited to VFR use only.

Section 3 EMERGENCY PROCEDURES

There are no special procedures required for use of this radio system in the event of an aviation emergency.

Section 4 NORMAL OPERATING PROCEDURES

As already mentioned, the keypad microphone is only needed for special purpose calls, such as selective calling (Selcall), telephone calls, and GPS position calls. It is not needed for normal communication with Flight Service stations. For this reason it is recommended that you stow this unit in some convenient place, within reach from the pilot's seat.

The keypad microphone does **not** need to be connected to the radio for normal voice transmissions. The aircraft microphone, or pilot's headset, should be used when making calls from the Codan 9323 HF radio system when it is fitted to an aircraft.

CONTROL PANEL

The pilot's control panel for the 9323 HF Radio consists of 10 pressure sensitive switch pads, 2 knobs (rotary switches), a 7-pin socket for the key-pad microphone, and an illuminated Display Window.

The DISPLAY Window

Channel numbers are shown in large figures in the centre of the display window. (Eg: "5" for channel 5.) The receive frequency is shown, in kilohertz, in smaller figures to the right of the channel number (Eg: 6541). If a bar, or line, is displayed above the channel frequency numbers (eg: 5025) [ABC Katherine] then this means that this is a receive only channel, and transmission has been inhibited on this frequency.

Further information relating to the particular channel selected may be shown in the top left hand corner of the display window.

A small bar-graph in the bottom centre of the display window gives an indication of transmitter output power, or received signal strength.



Pressing the ON/OFF key-pad switches the transceiver ON or OFF. Power-up messages appear briefly in the display window immediately after switch on.



The SELECT knob is used to change channels when the transceiver is in Channel Mode (which is the normal operating mode). The radio will be in this mode after initial switch-on).



The VOLUME knob acts in a similar way to the volume control on most other radio receivers, when the 9323 is in Channel Mode.

The two knobs marked **Volume** and **Select** may also be used to enter messages or channel information when used in other modes. You can find out about these functions by studying the 9323 User Guide, but you do not need these facilities for normal communication with FSU stations.

As you adjust the **Volume** or **Select** knobs any mute function of the receiver momentarily switches off. There are no mechanical stops on these knobs, but when you reach either maximum or minimum volume settings the receiver will emit a sharp beep sound through the headphones, or speaker.



Pressing on the TUNE key-pad will transmit a signal which will tune the HF antenna. When the 9323 is initially turned on, or after you have changed channels, pressing the Tune pad for one or two seconds will tune the antenna to your operating channel. This tune cycle should be repeated each time you change channels.

However, if you have not tuned the HF antenna in this way, then the system will automatically begin to tune the antenna coupler as soon as you attempt to transmit on the HF radio. This may mean that the first word or two of your transmission will be unreadable.



Pressing the SCAN key-pad starts or stops the scanning function. However, as this feature is not essential for use with Flight Service stations it is not described in detail here. Use of scanning mode is described on pg. 3-23 of the 9323 User Guide.





The VOICE MUTE switch is used to silence the 9323 receiver, so that you do not have to listen to constant background noise. When Voice Mute is selected the HF receiver will become active only when an audible signal is detected. If the receiver is in SCAN mode, then it will stop scanning and remain briefly on any channel where a signal has been detected. When Voice Mute has been selected the red LED at the top left hand corner of the Voice Mute pad will be illuminated.



The SELCALL MUTE switch also mutes the HF receiver. However when operating in this mode the receiver will only become active if (or when) a coded Selcall tone, identified as having been addressed to this particular aircraft (or this particular radio station), is received. For this reason **Selcall Mute must not be used if you are maintaining a listening watch on Australian Domestic Flight Service frequencies.** When Selcall Mute has been selected the red LED at the top left hand corner of the S'call Mute pad will be illuminated.



The MODE key-pad is used to select different operating modes for the transceiver. Repeatedly pressing the Mode key-pad will cycle through six different self explanatory menu pages. If you need more information about the various modes of this radio they are explained in the Codan 9323 HF Transceiver User Guide.

-  The F1 switch-pad performs different functions depending on the operating mode, which has previously been selected on the MODE switch. The current function of the F1 switch is shown in the bottom left hand corner of the display window.
-  The F2 switch-pad performs different functions, depending on the operating mode of the transceiver. The current function of the F2 switch is displayed in the lower right hand corner of the display window.
-  The EMGCY CALL switch may be used to send emergency selcalls on certain RFDS channels. This is normally assumed to be for medical situations of extreme emergency. Use of RFDS Emergency Call is explained on pg 6-5 of the 9323 User Guide.

To adjust RECEIVER CLARIFIER Control

With the transceiver in **Channel** mode (the normal operating mode) press the MODE key-pad once to put the system in **Clarifier** mode. Then rotate the **Select** knob to fine tune the receiver. When required, press the MODE key-pad to return to **Channel** mode.

To adjust the BRIGHTNESS of the DISPLAY

Press and hold down the ON/OFF key-pad. Then, with pressure still applied to this pad, rotate the **Volume** control to adjust display brightness. When the backlighting has been set to the desired level, remove your finger from the ON/OFF key-pad.

To adjust CONTRAST of the display

Press and hold down the ON/OFF key-pad. Then, with pressure still applied to this pad, rotate the **Select** knob. Clockwise to increase contrast, and anti-clockwise to decrease contrast. When the contrast has been adjusted to your satisfaction release the ON/OFF key-pad.

NOTE The transceiver will not switch off if the Select knob or the Volume knob are adjusted in the procedure described above.

Other functions of the 9323 HF SSB Transceiver, including transmission of GPS position, Selective calling, telephone calls, and other specialist functions, are described in the 9323 HF SSB Transceiver User Guide.

Section 5

AIRCRAFT PERFORMANCE

Use of this HF Transceiver should not have any affect on aircraft performance.

Section 6

WEIGHT AND BALANCE

Operation of this radio equipment does not change the aircraft weight and balance data. **HOWEVER**, in the event that components of the HF radio system are removed for some reason then possible changes to the aircraft weight and balance data must be considered. .

MAF Aviation Services

Australia

AFM Supplement 0623-039F01

VH-ASJ

U206 5867

Codan9323 HF SSB Transceiver

CESSNA 206 AIRCRAFT FLIGHT MANUAL SUPPLEMENT

MAF CARGO RESTRAINT SYSTEM

This supplement is required to be inserted into the Aircraft Flight Manual when the aircraft is equipped with the MAF Aviation Services Cessna 206 Cargo Restraint System in accordance with MAF Aviation Services Engineering Order 163.

The information contained herein supplements the information of the Aircraft Flight Manual. For limitations, procedures and performance data not contained in this supplement, consult the Aircraft Flight Manual.

List of Effective Pages

Revision Number	Date	Page Number*
Initial Issue	28 February 2006	1 - 8
Revision 1	31 March 2009	1 - 8

*This Aircraft Flight Manual Supplement is an eight (8) page document. Any amendment to this document will necessitate the revision of the whole document. At each revision, amended paragraphs will be identified with a line down the right hand margin.

Approved:

MISSION AVIATION FELLOWSHIP
Airport, Mareeba Qld 4880, Australia
Certificate of Approval No. C017501

APPROVED

Pursuant to CAR 35(2)

P. H. Andrews
.....

Authorised Person, ARN No. 983870

Issue *Per* / Date 31 MAR 09

SECTION 1 – GENERAL

This supplement describes the features of the MAF Aviation Services Cessna 206 series cargo restraint system and provides instructions for its use in the above aircraft registration which has been modified in accordance with MAF Aviation Services Engineering Order 163. This cargo restraint system may be used to restrain up to 500 kg of cargo in the cabin aft of any passengers and crew. The system consists of the following equipment:

Description	Part Number	Requ'd
Cargo Net	MA419-1	1
Grey/Red Strap	MA0025-002D2-1 or ACL P/N C304TFSH	7
Blue Straps	MA0025-002D3-1 or ACL P/N 1519-14R-2	2
Corner Protector	FLCP1000	3

SECTION 2 - LIMITATIONS

The maximum cargo weight which may be placed behind cargo net MA419-1 is 500 kg when attached immediately aft of the crew seat row, 250 kg when attached immediately aft of the centre seat row, and 80 kg when attached immediately aft of the rear seat row.

Note: The forward edge of the load (depending on configuration) must end at least the following distances aft of backs of seats which are occupied by crew and/or passengers:

- (i) 9 inches aft of front row seat backs; or
- (ii) 4 inches aft of centre row seat backs; or
- (iii) 4 inches aft of aft row seat backs.

SECTION 3 - EMERGENCY PROCEDURES

Following any incident in which the aircraft is subjected to high impact loading with the cargo restraint system in use, the cargo net with all straps and fittings must be removed and inspected. Any evidence of permanent deformation of hardware items, or failure of webbing and stitching is cause for rejection of the entire cargo restraint system.

SECTION 4 - NORMAL PROCEDURES

4.1 Introduction

The cargo net must always be attached directly to the large tie-down fittings at either side of the rear window by means of the snaphooks at the aft (narrow) end of the net. In order to accommodate various cargo configurations, the cargo net incorporates D-rings in a number of places and with forward and sideways orientations. In general, when cargo has been loaded the net must be fastened to the appropriate tie-down fittings in the aircraft with the required number of cargo straps at the forward end and on each side, as detailed in the following paragraphs. The upper end of a red cargo strap is defined as that end which is nearest to the adjuster. Each red cargo strap used must always be attached to a tie-down fitting at its lower end and the nearest appropriately oriented D-ring on the net should then be selected for fastening the upper end of each cargo strap.

4.2 Procedure (Refer to diagram on page 5)

4.2.1 Attach the snap hooks at the aft end of the net to the large tie-down fittings either side of the rear window and direct the remainder of the net outside the cargo door to facilitate loading cargo.

4.2.2 If one or more passenger seats are removed in order to load cargo:

Attach the lower ends of three red cargo straps to the forward-facing large tie-down fittings across the cabin floor either immediately behind the crew seat row or immediately behind the centre seat row, or to the small tie-down fittings behind the rear seat row depending on amount of cargo to be restrained. Lay red straps out longitudinally with adjusters at the forward end and facing downwards.

4.2.3 All configurations:

As far as possible, position heavier and bulkier items at the front of the load. Load cargo partially over the bottom ends of the three red straps which have already been laid out, thereby constraining the lower parts of each strap to run forward along the floor before turning upwards.

When loading is complete place the net evenly over the cargo and pull firmly down at the front and sides. If the full length of the net is not required fold the excess length at the front of the load.

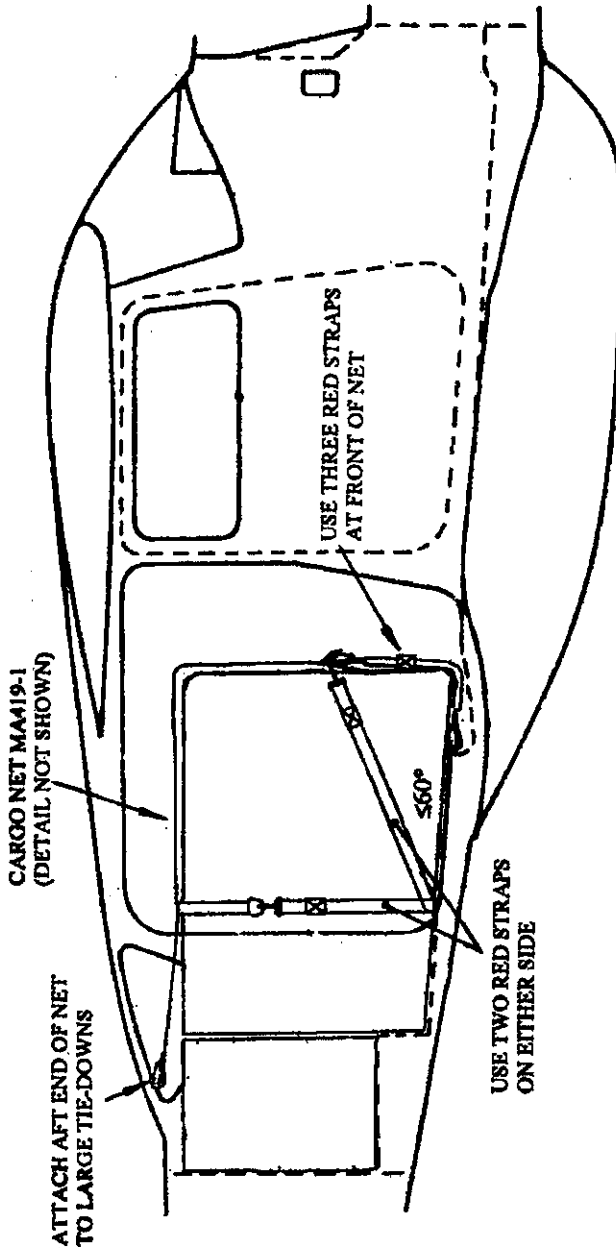

TYPICAL LOAD CONFIGURATION

4.2.4(a) If all passenger seats are fitted and all cabin cargo is stowed behind the aft passenger seat:

Attach the upper ends of the three red straps previously attached to the floor to the nearest forward facing D-rings on the net, pull the adjustment tight, and ensure that adjusters are locked.

Note: The maximum cargo weight which may be placed behind the aft passenger seat is 80 kg.

4.2.4(b) If the rear seat row only has been removed and three red straps attached immediately behind the centre seat row:

Note 1: The maximum cargo weight which may be restrained by the net behind the centre seat row is 250 kg.

Attach the upper ends of the three red straps to the nearest forward facing rings on the net, pull the adjustment tight, and ensure adjusters are locked. If the lower front edge of the load is sharp-edged, position corner protectors inside the front three red straps before tightening. Attach two red straps to each of the two outboard rear seat row seat belt attachments. Attach the upper end of one strap from each side to the nearest sideways oriented ring on the net and pull adjustment tight to provide vertical restraint near the middle of the load. Draw the remaining two straps forward around the side of the net to the front of the net and attach the upper ends to forward facing rings on the outboard webs at approximately half the height of the load. The angle these straps makes with the horizontal must not exceed 60°. (Refer to diagram on page 5).

4.2.4(c) If both the centre and rear seat rows have been removed and three red straps attached immediately behind the crew seat row:

Note 1: The maximum cargo weight which may be restrained by the net when attached just behind the crew seat row is 500 kg.

Attach the upper ends of the three red straps to the nearest forward facing rings on the net, pull the adjustment tight, and ensure adjusters are locked. If the lower front edge of the load is sharp-edged, position corner protectors inside the front three red straps before tightening. Attach one red strap at each side of the net vertically from a large tie-down or seat belt fitting near the middle of the load, to the nearest sideways oriented ring on the net and pull adjustments tight. Attach the bottom ends of the remaining two red straps to large tie-down fittings not already in use on either side of the net and draw them forward around the side of the net to the front. Attach the upper ends of these straps to forward facing rings on the outboard webs of the net at approximately half the height of the load. The angle these straps make with the horizontal must not exceed 60°. (Refer to diagram on page 5).

4.3 In addition to basic requirements a sufficient number and location of red and/or blue cargo straps must be used to prevent all items of cargo from moving forward, aft, upward and sideways.

4.4 When cargo consists of one large heavy item:

The blue cargo straps alone may be used. These straps should be attached to the large tie-down fittings or seat belt attachments only. The total weight of cargo divided by the number of large tie-downs used behind the cargo must not exceed 135 kg. Similarly, the maximum load carried by each seat belt attachment used as a cargo tie-down must not exceed 90 kg.

SECTION 5 - PERFORMANCE

No change.

SECTION 6 - WEIGHT AND BALANCE

For the installation of net, 2 blue straps, 7 red straps and 3 corner protectors :

Weight Added: 11.9 kg Arm: depends on storage location.

Refer to the current applicable MAF Cessna TU206F/G and U206F/G Loading and Trim Sheet.

For all other Weight and Balance requirements refer to Section 6 in the Aircraft Flight Manual.

Mission Aviation Fellowship
Airport, Mareeba Qld 4880, Australia
AFM Supplement 0023-015F01

VH-ASJ
U20605867
Kannad 406 AF-Compact ELT

CESSNA 206 AIRCRAFT FLIGHT MANUAL SUPPLEMENT

KANNAD 406 AF-COMPACT ELT

This supplement is required to be inserted into the Aircraft Flight Manual when the aircraft is equipped with the Kannad 406 AF-Compact ELT in accordance with MAF Engineering Order 0023-015E1.

The information contained herein supplements the information of the Aircraft Flight Manual. For limitations, procedures and performance data not contained in this supplement, consult the Aircraft Flight Manual.

List of Effective Pages

Revision Number	Date	Page Number*
Initial Issue	3 April 2009	1 - 4

*This Aircraft Flight Manual Supplement is a four (4) page document. Any amendment to this document will necessitate the revision of the whole document. At each revision, amended paragraphs will be identified with a line down the right hand margin.

Approved:

MISSION AVIATION FELLOWSHIP Airport, Mareeba Qld 4880, Australia Certificate of Approval No. C017501 APPROVED Pursuant to CAR 35(2)  Authorised Person, ARN No. 583870 Issue 0 Date 3 APR 09
--

SECTION 1 – GENERAL

This supplement is provides the operational procedures for the Kannad 406 AF-Compact Emergency Locator Transmitter (ELT). The Kannad 406 AF-Compact ELT is an automatic activation ELT that transmits on 121.5 and 406 MHz frequencies.

The transmitter unit is located in the tailcone and the remote cockpit display incorporating a switch and indicator light is installed on the instrument panel.

In the event of a crash, the Kannad 406 AF-Compact ELT activates automatically and transmits the standard swept tone on 121.5 MHz lasting until the battery power is gone. Also for the first 48 hours a 406 MHz signal is transmitted at 50 second intervals containing the identification data programmed in the ELT. This data is referenced by the national authority responsible for ELT registration and is used to identify the beacon and owner.

SECTION 2 – LIMITATIONS

Australian Maritime Safety Authority (AMSA) Registration date: 30 OCT 2008

Registered Beacon Hex ID: BEE64BE5638D3A1

Registered Callsign: VH-ASJ

Registration expiry date: 30 OCT 2010

SECTION 3 - EMERGENCY PROCEDURES

Manual Activation

Front Panel Switch ON

SECTION 4 - NORMAL PROCEDURES

Front Panel Switch ARMED

Accidental Activation

If the ELT is activated accidentally, then rock the Front Panel Switch to the RESET position.

When the ELT is transmitting an aural buzzer sounds and the indicator light on the front display panel flashes.

SECTION 5 - PERFORMANCE

No change.

SECTION 6 - WEIGHT AND BALANCE

At the time of installation the Weight and Balance Record was updated in accordance with MAF Engineering Order 0023-015E1.

The weight of the Kannad 406 AF-Compact ELT is 0.9 kg.

For all other Weight and Balance requirements refer to Section 6 in the Aircraft Flight Manual.

**Cessna U206G
AIRCRAFT FLIGHT MANUAL
SUPPLEMENT**

INSTRUMENT MARKING IN LITRES

This supplement is required to be inserted into the Aircraft Flight Manual when the aircraft has been modified in accordance with MAF Engineering Order 0628-004E1.

The information contained herein supplements the information of the Aircraft Flight Manual. For limitations, procedures and performance data not contained in this supplement, consult the Aircraft Flight Manual.

List of Effective Pages

Revision Number	Date	Page Number*
Initial Issue	9/08/2011	1-9

*This Aircraft Flight Manual Supplement is an nine (9) page document. Any amendment to this document will necessitate the revision of the whole document. At each revision, amended paragraphs will be identified with a line down the right hand margin.

APPROVED: Authorised Person per CAR (1988) 35

Mission Aviation Fellowship
Airport, Mareeba Qld 4880, Australia
Certificate of Approval No. C017501

APPROVED

Pursuant to CAR 21.006A

.....
Authorised Person, ARN No. 583870

Issue 0 Date 9 AUG 11

SECTION 1 GENERAL

DESCRIPTIVE DATA

FUEL

Total Capacity: 348 Litres.
Total Capacity Each Tank: 174 Litres.
Total Usable: 332 Litres.

SECTION 2 LIMITATIONS

POWER PLANT INSTRUMENT MARKINGS

Power plant instrument markings and their colour code significance are shown in Figure 2.1.

INSTRUMENT	RED LINE	GREEN ARC	YELLOW ARC	RED LINE
	MINIMUM LIMIT	NORMAL OPERATING	CAUTION RANGE	MAXIMUM LIMIT
Fuel Flow (Pressure)	(3.5) psi	27 – 64 L/hr	---	95 L/hr (19.5 psi)
Fuel Quantity	E (8 L Unusable Each Tank)	---	---	---

Figure 2.1 Power Plant Instrument Markings

FUEL LIMITATIONS

2 Standard Tanks: 174 Litres each.
Total Fuel: 348 Litres.
Usable Fuel (all flight conditions): 332 Litres.
Unusable Fuel: 15 Litres.

PLACARDS

1. On fuel selector plate:

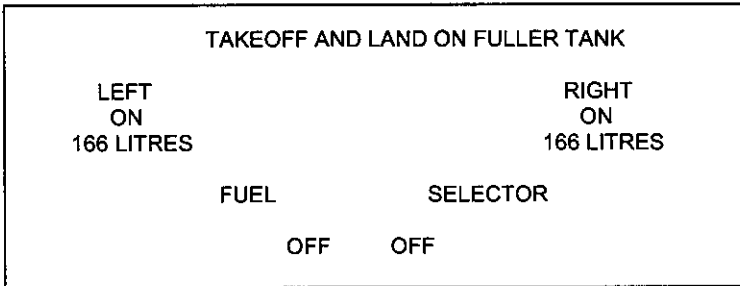

2. Forward of fuel tank filler caps:

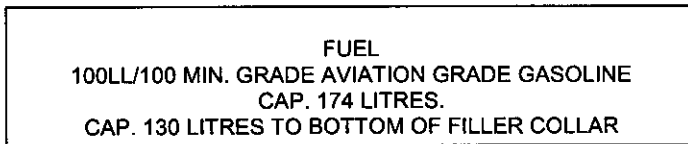

3. Near manifold pressure/fuel flow indicator:

MIN FUEL FLOWS AT FULL THROTTLE				
RPM	S.L.	4000	8000	12000
2700	87 L/HR	79 L/HR	72 L/HR	64 L/HR
2850	91 L/HR	83 L/HR	76 L/HR	68 L/HR

SECTION 3 EMERGENCY PROCEDURES

No change.

SECTION 4 NORMAL PROCEDURES

STARTING ENGINE

7. Throttle -- ADVANCE to obtain 30 - 38 litres/hr fuel flow, then return to CLOSED position.

NORMAL CLIMB

3. Mixture -- LEAN to 68 litres/hr.

AMPLIFIED PROCEDURES

STARTING ENGINE

When ready to start, place the auxiliary fuel pump switch in the ON position and advance the throttle to obtain 30 - 38 litres/hr fuel flow.

2. When the ignition switch is in the BOTH position and you are ready to engage the starter, place the right half of the auxiliary fuel pump switch ON until the indicated fuel flow comes up to 15 to 23 litres/hr; then turn the switch off.

NOTE

During a restart after a brief shutdown in extremely hot weather, the presence of fuel vapour may require the auxiliary fuel pump to operate in the ON position for up to 1 minute or more before the vapour is cleared sufficiently to obtain 15 to 23 litres/hr for starting. If the above procedure does not obtain sufficient fuel flow, fully depress and hold the left half of the switch in the HI position to obtain additional fuel pump capability.

ENROUTE CLIMB

Cruising climbs should be conducted at 68 litres/hr up to 4000 feet and then at the fuel flow shown on the normal climb chart in Section 5 for higher altitudes.

SECTION 5 PERFORMANCE

**TAKEOFF DISTANCE
MAXIMUM WEIGHT 3600 LBS
SHORT FIELD**

MIXTURE SETTING	
PRESS ALT	L/HR
S.L.	91
2000	87
4000	83
6000	79
8000	76

MAXIMUM RATE OF CLIMB

MIXTURE SETTING	
PRESS ALT	L/HR
S.L.	87
4000	79
8000	72
12000	64
16000	57

TIME, FUEL, AND DISTANCE TO CLIMB

MAXIMUM RATE OF CLIMB

MIXTURE SETTING	
PRESS ALT	L/HR
S.L.	87
4000	79
8000	72
12000	64
16000	57

NOTES:

1. Add 8 litres of fuel for engine start, taxi and takeoff allowance.

FUEL USED

Multiply the POH fuel figure (in US gallons) by 3.785 to determine fuel used in litres.

TIME, FUEL, AND DISTANCE TO CLIMB

NORMAL CLIMB – 95 KIAS

MIXTURE SETTING	
PRESS ALT	L/HR
S.L. to 4000	68
6000	64
8000	61
10000	57

NOTES:

1. Add 8 litres of fuel for engine start, taxi and takeoff allowance.

FUEL USED

Multiply the POH fuel figure (in US gallons) by 3.785 to determine fuel used in litres.

CRUISE PERFORMANCE

NOTE

For best fuel economy at 65% power or less, operate at 4 L/HR leaner than shown in this chart or at peak EGT if an EGT indicator is installed.

Multiply the POH fuel figure (in US gallons per hour) by 3.785 to determine fuel used in litres.

RANGE PROFILE

45 MINUTES

246 LITRES USABLE FUEL

See Figure 5-9 (Sheet 1 of 2)

RANGE PROFILE

45 MINUTES

333 LITRES USABLE FUEL

See Figure 5-9 (Sheet 2 of 2)

ENDURANCE PROFILE
45 MINUTES
246 LITRES USABLE FUEL

See Figure 5-10 (Sheet 1 of 2)

ENDURANCE PROFILE
45 MINUTES
333 LITRES USABLE FUEL

See Figure 5-10 (Sheet 2 of 2)

SECTION 6

WEIGHT AND BALANCE

For all Weight and Balance requirements refer to Section 6 in the Aircraft Flight Manual and Section 6 in the Supplemental Flight Information Folder.



Flying for Life

SUPPLEMENTAL FLIGHT INFORMATION

REG: VH-ASJ

TYPE: Cessna U206G

S/#: U20605867

**Note: This information does not form part of the
approved Aircraft Flight Manual**

**2.1 RADIO SYSTEMS APPROVED FOR DAY and NIGHT
VFR OPERATION**

The following equipment has been approved for day and night VFR operations, Where the individual equipment's operation is altitude limited for the operation performed, this altitude is shown in the table below. If the maximum operational limitation of the equipment exceeds the maximum approved altitude of the aircraft to which it is installed then **NL** (not limiting) will be shown in the table.

The radio communication and navigation systems installed in the aircraft approved for VFR only should not be relied upon.

SYSTEM	EQUIPMENT	
VHF COM 1	KY96A	
VHF COM 2	KY96A	
ATC XPDR	GTX320A	
HF Comm	Codan 9323	
GPS	Garmin GPS100	No Operational Approval
GPS Course Indicator	IN-385	

Amended: 25/10/2002

GENERAL

1.1 The radio communication and radio navigation equipment in this aircraft are approved for the type of operation as specified on the appropriate pages included in this section. The maximum operating altitude of the equipment (expressed in feet) when specified, is limiting on the aircraft when this equipment is mandatory for the type of operation being performed.

1.2 Before the aircraft may engage in any operation the instruments, radio systems, and equipment which are required in accordance with the appropriate section of Civil Aviation Orders Part 20 for the operation to be performed, shall be installed and approved by the Authority.

1.3 All equipment is to be airworthy to the standards required for that operation. Unserviceability of instruments, radio systems, and equipment, are to be placarded and recorded on the Maintenance Release.

1.4 Only types of operation which are covered by the applicable page being included in this section, are approved by the Authority.

LC-2 DIGITAL CHRONOMETER

LIQUID CRYSTAL
DISPLAY

TIMER
ANNUNCIATOR
POSITION

TIME SET
(CLOCK)

RESET
(TIMER)

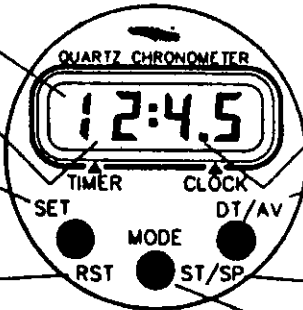

CLOCK
ANNUNCIATOR

DATE/ADVANCE
(CLOCK)

START/STOP
(TIMER)

MODE SELECTOR

MODE SELECTION

The **MODE** button is pressed to select the desired operation, either Clock or Timer. In the Timer Mode, the annunciator will appear above the word Timer. In the Clock Mode, the annunciator will appear above the word Clock if in 12 hour mode.

NOTE: The clock can be switched internally for either 12 or 24 hour operation. In the 24 hour mode, there is no clock annunciator.

CLOCK MODE

Press the **MODE** button to position the annunciator above the word **CLOCK**. Words above the left and right buttons describe the buttons in the clock mode.

Date Setting: Press the **SET** button one time. The month's digit will flash. Press the **DT/AV** button to advance the digit to the desired month. Press the **SET** button one time and the day's digit will flash. Press the **DT/AV** button to advance to the desired day. Press the **SET** button, and the date is now set.

Time Setting: 12 or 24 hour time is displayed according to setting of the internal 12/24 hour switch. In 24 hour clock operation, the clock annunciator on the display does not appear. Clock or timer function is indicated only by the timer annunciator on the display.

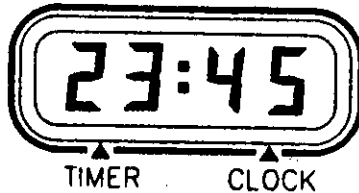

To set the time, press the **SET** button to cause the hour's digit to flash. Press the **DT/AV** button until the desired hour is displayed. Then press the **SET** button one time to cause the minute's digit to flash. Press the **DT/AV** button to advance the minutes to the next minute coming up. The **SET** button is pressed once more to hold the time displayed. When the time standard used shows the exact time displayed, press the **DT/AV** button to start the clock function at the exact second.

Note: It is always necessary to go through the date step before setting the time. If the date is correct, simply press the **SET** button four times to cause the hour's digit to flash. Then proceed with instructions above to set time.

If the minutes are not advanced when they are flashing in the set mode, pressing the **SET** button will return the clock to the normal time keeping mode without altering the minutes. This feature is useful when changing time zones.

CLOCK OPERATION

Normal clock operation will be indicated by the colon which blinks every ten seconds.

DATE OPERATION

With the Clock Mode selected, momentarily pressing the **DT/AV** button will activate the date mode to the display. The Month:Date will be visible for 1.5 seconds. The display will then automatically return to the clock display. During the display of the date, the Clock annunciator will be blanked from the display.

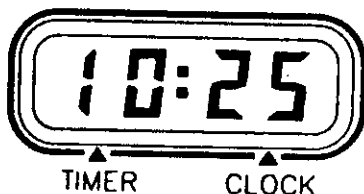

Note: If in the Clock Mode, the colon is not flashing every ten seconds, press and hold the **DT/AV** button until the time returns. This will activate proper colon operation.

TIMER MODE

Press the **MODE** button to position the annunciator above the word **TIMER**. Labels below the left and right buttons describe timer functions. To start the timer counting, press the **ST/SP** button one time.

TIMER OPERATION

The timer will initially count in minutes and seconds, and the colon will blink every second. After 59 minutes and 59 seconds, the timer will change to count in hours and minutes up to a maximum of 23 hours and 59 minutes. During the hours and minutes count, the colon will indicate counting activity by blinking every ten seconds.

The timer count may be stopped and held at a particular time by pressing the **ST/SP** button. To add to the existing count, press the **ST/SP** button again, and the timer will continue counting up from the previous total. To start a new count, press the **RST** button to zero the display. Press the **ST/SP** button to start a new count.

During the hours and minutes count, the hold mode can be recognized by the lack of colon activity for a ten second duration. The colon may be continuously on or off in the hold mode.

DISPLAY TEST

This test should be done with the clock in the **Timer Mode**.

Pressing both the **SET** and **DT/AV** buttons at the same time will result in a display test function. All display segments, colon, and annunciators will be activated. The clock will return to the timer mode (if the display test is done in the Clock Mode, it will return in the set condition and have to be reset.)

Astrotech Corporation, 2321 Topaz Drive, Hatfield, PA 19440
Phone (215) 997-3590; Fax (215) 822-7974
Website www.astro-tech.com

ATP00675

ATS00675 Rev. C 09/97